

CATÁLOGO 2024

Mediterránea de Válvulas

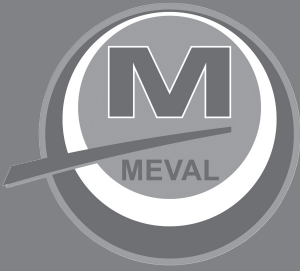



TARIFA **2024**

CODIGOS QR DE DESCARGA



Fecha de 1ª. edición / 1ª. Edition Date / Date 1ª d'edition : **5/2008**
Fecha de 2ª. edición / 2ª. Edition Date / Date 2ª d'edition : **7/2008**
Fecha de 3ª. edición / 3ª. Edition Date / Date 3ª d'edition : **6/2009**
Fecha de 4ª. edición / 4ª. Edition Date / Date 4ª d'edition : **6/2011**
Fecha de 5ª. edición / 5ª. Edition Date / Date 5ª d'edition : **6/2013**
Fecha de 6ª. Edición / 6ª. Edition Date / Date 6ª d'edition : **6/2019**
Fecha de 7ª. Edición / 7ª. Edition Date / Date 7ª d'edition : **10/2024**



Queda prohibida la reproducción total o parcial de este catálogo sin autorización expresa y por escrito de Mediterránea de Válvulas, S.L. que se reserva el derecho a modificar total o parcialmente el contenido de dicho catálogo.

INDICE

VÁLVULAS DE LATÓN		10 - 14
Válvulas escuadra	10	
Grifos lavadora	12	
Accesorios	14	
GRIFERÍA TEMPORIZADA		16 - 21
Grifos lavabo	16	
Grifos mural	17	
Grifos fuente	17	
Grifos ducha	19	
Grifos urinario	20	
Fluxómetros y tubos	21	
Rejilla urinario	21	
GRIFOS DE PEDAL		24 - 25
Grifos un pedal	24	
Grifos dos pedales	25	
Caños fijos y giratorios	25	
GRIFERÍA MEDICAL		28 - 29
GRIFERÍA SERIE CATI		32
GRIFERÍA SERIE NICE		33
GRIFERÍA SERIE MINIMALISTA		34
GRIFERÍA SERIE ESFERA		35
GRIFERÍA TERMOSTÁTICA		36
GRIFERÍA HIGIÉNICA WC/BIDET		37
COLUMNAS DE DUCHA		40
GRIFERÍA DE FREGADERO		42 - 46
Monomandos	42	
Baterías	45	
Monoblocs	46	



INDICE

GRIFERÍA DE UN AGUA	48 - 51
Monomandos	48
Baterías	50
Office	51
RECAMBIOS DE GRIFERÍA	56
ACCESORIOS DE GRIFERÍA	58 - 62
Fijaciones y excéntricas	58
Conexiones flexibles	59
Accesorios grifo extraíble	59
Cartuchos y monturas	60
Atomizadores	61
Adaptadores grifería	62
COMPLEMENTOS DE BAÑO	64 - 72
Mangos de ducha	64
Flexos de ducha	67
Rociadores	68
Brazos y barra de ducha	70
Soportes de ducha	71
Barras de seguridad	72
VÁLVULAS DESAGÜE	74 - 80
Válvulas click-clack	74
Válvulas automáticas y manuales	76
Válvulas bañera y ducha	77
Tapa orificios y tapones	79
Cadena y anillas	80
FILTROS DESAGÜE	82
SIFONES DESAGÜE Y ACCESORIOS	84 - 87
ENCHUFES DE GOMA	90
CABEZALES UNIVERSALES, ACCESORIOS Y REPUESTOS	92 - 96
CONEXIONES FLEXIBLES	98 - 104
Serie A	98
Termo "Serie Súper"	100
Batería de contador	102
Bomba de agua	103
CONEXIONES PARA LAVADORA	106

INDICE

VÁLVULAS ESFERA EMPOTRAR Y ACCESORIOS	108 - 109
VÁLVULAS DE CONTROL	112 - 116
Soldar	112
Roscar	113
Recambios	114
VÁLVULAS DE ESFERA	118 - 121
Válvulas esfera palanca	118
Válvulas esfera cuadradillo	119
Válvulas esfera palomilla	120
Válvulas esfera mini	121
GRIFOS CURVOS Y ACCESORIOS	124 - 126
Grifo curvo esfera	124
Grifo curvo candado	125
Grifo curvo polipropileno y antihielo	125
Racor, enchufe, unión y boquilla adaptables	126
GRIFOS DECORATIVOS	128 - 129
REDUCTORES DE PRESIÓN Y MANÓMETROS	132 - 133
VÁLVULAS DE RETENCIÓN Y FILTROS	136 - 140
Válvulas de retención H-H	136
Filtros	137
Válvulas de retención M-M	137
Válvulas de retención clapeta	138
Filtro colador tipo "Y"	138
Válvulas de compuerta	138
Válvulas esfera 3 vías	139
Válvulas esfera con retención incorporada	139
Válvulas esfera contador y accesorios	140
RACORES DE CONTADOR Y ACCESORIOS	142
ACCESORIOS TUBO POLIETILENO	144 - 148
Anillo de latón	144
Anillo de acero inox. con bridas	146
Recambios	148
GRIFOS FLOTADORES Y BOYAS	150 - 154
Flotadores	150
Boyas	152
Accesorios	154



INDICE

CISTERNA E INODORO **156 - 165**

Descargadores y gomas	156
Cisterna y accesorios	159
Tiradores	160
Gomas y juntas	161
Manguitos y tapones	162
Tapas inodoro	164
Accesorios de baño	165

ACCESORIOS DE FIJACIÓN **168 - 169**

RACORERÍA DE LATÓN ROSCAR **172 - 186**

Machón doble	172
Marsella hexagonal	174
Reducción hexagonal	175
Reducción lisa	175
Codos	176
Te H-H-H	178
Manguitos	179
Tapón Hembra	180
Tapón Macho	181
Unión 3 piezas	182
Racor depósito uralita	183
Arandela acero, latón y acero inox.	183
Tuercas correderas	184
Alargaderas cilíndricas pulidas y cromadas	184
Codo 3 bocas, cruz 4 bocas, Te 5 vías	185
Bebadero de cerdo	185
Curvas de 90°	185
Collarines	186
Manguitos electrolíticos	186

RACORERÍA DE LATÓN SOLDAR **188 - 190**

Codos	188
Enlaces y entronques	189
Te H, tapones, curva desviación	190

RACORERÍA DE LATÓN PARA RIEGO **192 - 195**

NIPPELS GALVANIZADOS **198 - 200**

VÁLVULAS DE FUNDICIÓN **202 - 204**



Racores unión	202
Abrazaderas de reparación	203
Conexiones manguera	204
Manguitos antivibratorios	204

INDICE

CALEFACCIÓN	206 - 215
Purgadores automáticos	206
Purgadores manuales	207
Válvulas de seguridad y retención	207
Válvulas y detentores manuales para radiador	208
Válvulas termostatzables para radiador	210
Colectores	211
Tuercas	212
Florones y tapones	213
Termostatos y cronotermostatos	214
Soportes y complementos	215
JUNTAS Y ARANDELAS	218 - 221
Juntas tóricas	218
Juntas planas	219
Arandelas de goma y juntas de fibra	220
Juntas klinger y juntas de teflón	221
MEMBRANAS	224
SOLETAS Y PORTASOLETAS	226
ACCESORIOS DE SELLADO	228 - 229
ACCESORIOS PARA GAS	232 - 237
Reguladores y goma de butano	232
Gas hermeto y soldar	233
Soportes y tapas contador	237
ACCESORIOS DE VENTILACIÓN	240 - 242
Rejillas	240
Difusores	242
SUMIDEROS, CALDERETAS Y BOTE SIFÓNICO	244
ACCESORIOS DE COBRE	246 - 254
Racor recto	246
Racor curvo	248
Manguitos	249
Codos	251
Tapón Hembra	252
Curva de 90°	252
Curva de 45° y curva desviación	253
Te H-H-H	254



VÁLVULAS DE LATÓN

Válvulas escuadra		10
Grifos lavadora		12
Accesorios		14

VÁLVULAS DE LATÓN

VÁLVULA ESCUADRA

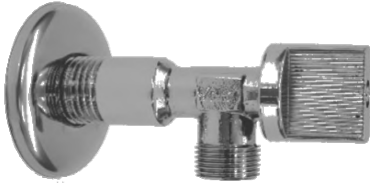

Código	Medida	Caja	EAN
10001	M 1/2" x M 3/8"	100	8435195800005
10003	M 1/2" x M 1/2"	100	8435195800029

- PN 16.
- Latón EN 12165 cromado.
- Temperatura máxima 90°C.
- Mando ABS 1/4 de vuelta con tornillo de sujeción.

VÁLVULA ESCUADRA ANTICAL



Código	Medida	Caja	EAN
10007	M 1/2" x M 3/8"	100	8435195848045

- PN 16.
- Fabricada en latón.
- Temperatura máxima 90°C.
- Mando ABS 1/4 de vuelta con tornillo de sujeción.
- **Eje de polímero antical.**
- Juntas interiores de EPDM.

VÁLVULA ESCUADRA A-96

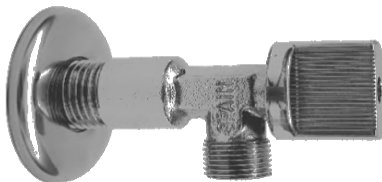

Código	Medida	Caja	EAN
10002	M 1/2" x M 3/8"	100	8435195800012
10004	M 1/2" x M 1/2"	100	8435195800036

- PN 16.
- Latón EN 12165 cromado.
- Temperatura máxima 90°C.
- Mando ABS 1/4 de vuelta con tornillo de sujeción.
- **SISTEMA PATENTADO**

VÁLVULA ESCUADRA A-96 MINI M-H



Código	Medida	Caja	EAN
10005	H 3/8" x M 3/8"	100	8435195800043
10006	H 1/2" x M 3/8"	100	8435195800050

- PN 16.
- Latón EN 12165 cromado.
- Temperatura máxima 90°C.
- Mando ABS 1/4 de vuelta con tornillo de sujeción.

VÁLVULAS DE LATÓN

VÁLVULA ESCUADRA A-96 LARGA



Código	Medida	Caja	EAN
10010	M 1/2" x M 3/8" 86 mm.	100	8435195800074
10012	M 1/2" x M 3/8" 96 mm.	100	8435195825442

- PN 16.
- Latón EN 12165 cromado.
- Temperatura máxima 90°C.
- Mando ABS 1/4 de vuelta con tornillo de sujeción.
- **SISTEMA PATENTADO**

VÁLVULA ESCUADRA CILÍNDRICA



Código	Medida	Caja	EAN
12101	M 1/2" x M 3/8"	100	8435195821482
12102	M 1/2" x M 1/2"	50	8435195825497

- PN 16.
- Latón EN 12165 cromado.
- Temperatura máxima 90°C.
- Montura cerámica.

VÁLVULA ESCUADRA MINIMALISTA

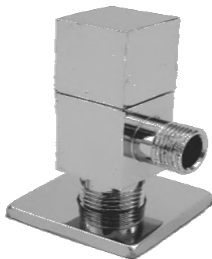

Código	Medida	Caja	EAN
12105	M 1/2" x M 3/8"	100	8435195821499
12106	M 1/2" x M 1/2"	50	8435195825503

- PN 16.
- Latón EN 12165 cromado.
- Temperatura máxima 90°C.
- Montura cerámica.

VÁLVULA ESCUADRA CON FILTRO

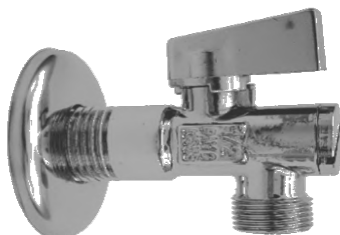

Código	Medida	Caja	EAN
12001	M 1/2" x M 3/8"	100	8435195820041
12004	M 1/2" x M 3/4"	50	8435195825480

- PN 16.
- Latón EN 12165 cromado.
- Temperatura máxima 90°C.
- Mando ABS 1/4 de vuelta con tornillo de sujeción.



VÁLVULAS DE LATÓN

GRIFO LAVADORA A-96

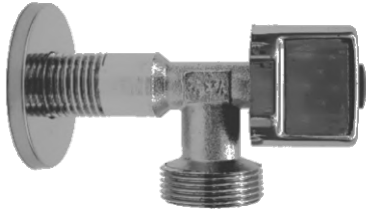

Código	Medida	Caja	EAN
11002	M 1/2" x M 3/4"	50	8435195800142

- PN 16.
- Latón EN 12165 cromado.
- Temperatura máxima 90°C.
- Mando ABS 1/4 de vuelta con tornillo de sujeción.
- **SISTEMA PATENTADO**

GRIFO LAVADORA MANDO SAFOR



Código	Medida	Caja	EAN
11004	M 1/2" x M 3/4"	50	8435195825459

- PN 16.
- Latón EN 12165 cromado.
- Temperatura máxima 90°C.
- Mando ABS SAFOR 1/4 de vuelta con tornillo de sujeción.

GRIFO LAVADORA

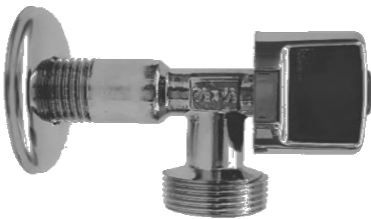

Código	Medida	Caja	EAN
11006	M 1/2" x M 3/4"	50	8435195820027

- PN 16.
- Latón EN 12165 cromado.
- Temperatura máxima 90°C.
- Mando ABS 1/4 de vuelta con tornillo de sujeción.

GRIFO LAVADORA CORTO



Código	Medida	Caja	EAN
11510	M 1/2" x M 3/4"	100	8435195820034

- PN 16.
- Latón EN 12165 cromado.
- Temperatura máxima 90°C.
- Mando ABS 1/4 de vuelta con tornillo de sujeción.

VÁLVULAS DE LATÓN

GRIFO LAVADORA CON VÁLVULA DE REGULACIÓN

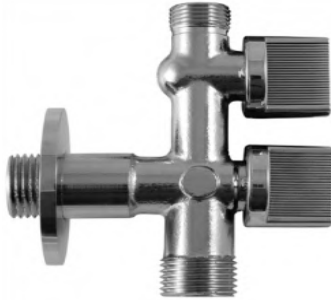

Código	Medida	Caja	EAN
11508	M 1/2" x M 3/4" x M 3/8"	50	8435195834048
11509	M 1/2" x M 1/2" x M 3/8"	50	8435195834055

- PN 16.
- Latón EN 12165 cromado.
- Temperatura máxima 90°C.
- Mandos ABS 1/4 de vuelta con tornillos de sujeción.
- Juntas interiores EPDM.
- Ejes de latón.

VÁLVULA MIXTA LAVADORA - LAVABO



Código	Medida	Caja	EAN
25517	M 1/2" x M 3/8" x M 3/4"	50	8435195801927

- PN 16.
- Latón EN 12165 cromado.
- Temperatura máxima 90°C.
- Mando ABS.

VÁLVULAS DE LATÓN

CODO LATÓN PULIDO Y CROMADO



Código	Medida	Caja	EAN
12130	M 1/2" x M 3/8"	50	8435195821505
12131	M 1/2" x M 1/2"	50	8435195821512

- Latón EN 12165 cromado.
- Temperatura máxima 90°C.
- Florón en acero inoxidable.

CODO MONOBLOC CROMADO



Código	Medida	Caja	EAN
64501	M 1/2" x M 3/8"	50	8435195810127

- Latón EN 12165 cromado.
- Temperatura máxima 90°C.

FLORÓN ACERO INOXIDABLE



Código	Medida	Caja	EAN
63501	3/8" Sin garras	100	8435195809671
63502	1/2" x 55 Sin garras	100	8435195809688
63504	1/2" x 55 Con garras	100	8435195809701
63506	1/2" x 65 Sin garras	100	8435195825510
63509	1/2" x 65 Con garras	100	8435195825527
63508	3/4" x 65 Sin garras	100	8435195808308

TUERCA ENLACE



	Código	Medida	Caja	EAN
Su color	71001	3/8" x 10 Ø	100	8435195811629
	71002	1/2" x 10 Ø	100	8435195811636
	71003	1/2" x 12 Ø	100	8435195811643
Cromo	71004	3/8" x 10 Ø	100	8435195811650
	71005	1/2" x 10 Ø	100	8435195811667
	71006	1/2" x 12 Ø	100	8435195811674

BICONO DE CAUCHO



Código	Medida	Caja	EAN
74002	3/8" x 10 Ø	100	8435195812206
74003	1/2" x 12 Ø	100	8435195812213
74004	1/2" x 10 Ø	100	8435195812220

GRIFERÍA TEMPORIZADA

Grifos lavabo		16
Grifos mural		17
Grifos fuente		17-18
Grifos ducha		19
Grifos urinario		20
Fluxómetros y tubos		21
Rejilla urinario		21



GRIFERÍA TEMPORIZADA

GRIFO LAVABO



Código	Medida	Caja	EAN
1001	1/2"	2	8435195817201

- Tiempo de apertura estándar de 8 a 12 segundos.
- Cuerpo fabricado en latón según EN1982 y cromado.
- Atomizador de latón.

	Código	Descripción	EAN
Recambio	1025	Montura + Pulsador	8435195848151

GRIFO LAVABO MINIMALISTA



Código	Medida	Caja	EAN
1002	1/2"	2	8435195821529

- Tiempo de apertura estándar de 8 a 12 segundos.
- Cuerpo fabricado en latón según EN1982 y cromado.
- Atomizador de latón.

GRIFO LAVABO MEZCLADOR



Código	Medida	Caja	EAN
1009	1/2"	2	8435195828283

- Tiempo de apertura estándar de 8 a 12 segundos.
- Dotado de válvula antirretorno
- Cuerpo fabricado en latón según EN1982 y cromado.
- Atomizador de latón.

	Código	Descripción	EAN
Recambio	1017	Montura + Pulsador	8435195834062

GRIFERÍA TEMPORIZADA

GRIFO MURAL



Código	Medida	Caja	EAN
1003	1/2"	2	8435195817218

- Tiempo de apertura estándar de 8 a 12 segundos.
- Cuerpo fabricado en latón según EN1982 y cromado.

	Código	Descripción	EAN
Recambio	1017	Montura + Pulsador	8435195834062

GRIFO MURAL



Código	Medida	Caja	EAN
1031	1/2"	2	8435195817294

- Tiempo de apertura estándar de 8 a 12 segundos.
- Cuerpo fabricado en latón según EN1982 y cromado.

	Código	Descripción	EAN
Recambio	1012	Montura + Pulsador	8435195817249

GRIFO FUENTE VERTICAL



Código	Medida	Caja	EAN
1033	3/8"	2	8435195817300

- Tiempo de apertura estándar de 8 a 12 segundos.
- Cuerpo fabricado en latón según EN1982 y cromado.

	Código	Descripción	EAN
Recambio	1014	Montura + Pulsador	8435195817263

GRIFO FUENTE CAÑO ALTO



Código	Medida	Caja	EAN
1034	3/8"	2	8435195817317

- Tiempo de apertura estándar de 8 a 12 segundos.
- Cuerpo fabricado en latón según EN1982 y cromado.

GRIFERÍA TEMPORIZADA

GRIFO FUENTE PÚBLICA S/COLOR



Código	Medida	Caja	EAN
1035	1/2"	1	8435195828290
1037	3/4"	1	8435195828306
1038	1"	1	8435195828313

• Cuerpo fabricado en latón según EN 1982.

GRIFO FUENTE PÚBLICA CROMO



Código	Medida	Caja	EAN
1047	1/2"	1	8435195828320
1048	3/4"	1	8435195828337
1049	1"	1	8435195828344

• Cuerpo fabricado en latón según EN 1982.

GRIFO FUENTE PÚBLICA PULSADOR FRONTAL S/COLOR



Código	Medida	Caja	EAN
1126	1/2"	1	8435195834093

• Cuerpo fabricado en latón según EN 1982.

GRIFERÍA TEMPORIZADA

GRIFO DUCHA / URINARIO EMPOTRAR



Código	Medida	Caja	EAN
1020	1/2"	2	8435195817287

- Tiempo de apertura estandar ducha: 15/25"
- Tiempo de apertura estandar urinario: 4/6"
- Cuerpo fabricado en latón según EN 1982.

GRIFO DUCHA / URINARIO VISTO



Código	Medida	Caja	EAN
1021	1/2"	2	8435195821529

- Tiempo de apertura pre regulada.
- Tiempo de apertura estandar urinario: 4/6"
- Cuerpo fabricado en latón según EN 1982.

GRIFO DUCHA MEZCLADOR EMPOTRAR



Código	Medida	Caja	EAN
1022	1/2"	2	8435195828139

- Tiempo de apertura estandar: 15/25"
- Dotada de válvula antirretorno.
- Cuerpo fabricado en latón según EN 1982.

GRIFO DUCHA MEZCLADOR VISTO



Código	Medida	Caja	EAN
1023	1/2"	2	8435195828146

- Tiempo de apertura estandar: 15/25"
- Dotada de válvula antirretorno.
- Cuerpo fabricado en latón según EN 1982.



GRIFERÍA TEMPORIZADA

GRIFO PREMEZCLADOR



Código	Medida	Caja	EAN
1057	1/2"	2	8435195817423

- Tiempo de apertura estándar: 12/16"
- Dotada de válvula antirretorno.
- Cuerpo fabricado en latón según EN 1982.

GRIFO URINARIO



Código	Medida	Caja	EAN
1010	1/2"	2	8435195817232

- Tiempo de apertura estándar de 8 a 12 segundos.
- Cuerpo fabricado en latón según EN 1982.
- Con accesorio para urinario recto.

	Código	Descripción	EAN
Recambio	1013	Montura + Pulsador	8435195817256
	1011	Tubo recto + florón	8435195815528
	1024	Tubo curvo 15,5cm+florón+tuerca	8435195834109

GRIFO URINARIO MINIMALISTA



Código	Medida	Caja	EAN
1050	1/2" Cuadrado	2	8435195821536
1016	1/2" Cilíndrico	2	8435195825572

- Tiempo de apertura estándar de 8 a 12 segundos.
- Cuerpo fabricado en latón según EN 1982.
- Tubo de salida ajustable.

VÁLVULAS DE LATÓN

FLUXÓMETRO EMPOTRAR TEMPORIZADO



Código	Medida	Caja	EAN
1064	3/4"	2	8435195817430

- Tiempo de apertura estándar de 5 a 8 segundos.
- Cuerpo fabricado en latón según EN 1982.

	Código	Descripción	EAN
Recambio	1004	Montura + Pulsador	8435195833997

FLUXÓMETRO VISTO TEMPORIZADO



Código	Medida	Caja	EAN
1065	3/4"	2	8435195817447
1075	1"	2	8435195817454

- Tiempo de apertura estándar de 5 a 8 segundos.
- Cuerpo fabricado en latón según EN 1982.

TUBO CROMADO EXTENSIBLE

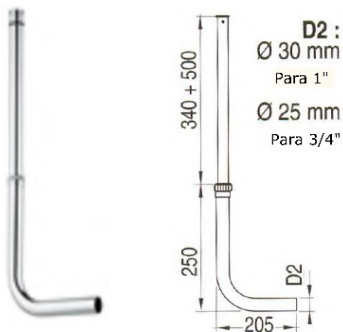

Código	Medida	Caja	EAN
1066	Ø 25 x 3/4"	2	8435195817461
1067	Ø 32 x 1"	2	8435195817478

- Accesorio para fluxómetro empotrado y visto.
- Cuerpo fabricado en latón según EN 12165.

FILTRO REJILLA URINARIO



Código	Medida	Caja	EAN
85121	Única	10	8435195823684



GRIFOS DE PEDAL

Grifos un pedal



24

Grifos dos pedales



25

Caños fijos y giratorios



25

GRIFOS DE PEDAL

GRIFO PEDAL UN AGUA



Código	Medida	Caja	EAN
1055	1/2"	2	8435195817416

- Cuerpo latón cromado.
- Regulación de caudal incorporado.
- Agua fría con caudal constante.
- Sujeción al suelo y pared.

GRIFO PEDAL UN AGUA TEMPORIZADO "LUX"



Código	Medida	Caja	EAN
1082	1/2"	2	8435195828153

- Cuerpo latón cromado.
- Regulación de caudal incorporado.
- Agua fría con caudal constante.
- Sujeción al suelo y pared.
- Modelo LUX.

GRIFO PEDAL MEZCLADOR



Código	Medida	Caja	EAN
1053	1/2"	2	8435195817386

- Cuerpo latón cromado.
- Regulación de caudal incorporado.
- Agua fría y progresivamente agua mezclada.
- Sujeción al suelo y pared.

GRIFOS DE PEDAL Y ACCESORIOS

GRIFO DOS PEDALES



Código	Medida	Caja	EAN
1056	1/2"	2	8435195817409

- Cuerpo latón cromado.
- Regulación de caudal incorporado.
- Agua fría y caliente. Pulsando ambos pedales: agua mezclada.
- Sujeción al suelo.

GRIFO DOS PEDALES



Código	Medida	Caja	EAN
1083	1/2"	2	8435195828160

- Cuerpo latón cromado.
- Regulación de caudal incorporado.
- Agua fría y caliente. Pulsando ambos pedales: agua mezclada.
- Sujeción al suelo y pared.
- Modelo LUX.

CAÑO FIJO

FUNDIDO A PARED



Cód. **1040**

Medida 1/2"

EAN 8435195817324

FUNDIDO A ENCIMERA

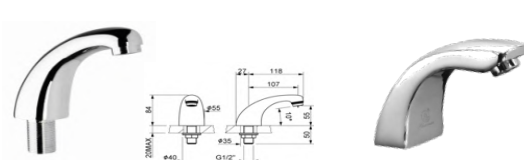

Cód. **1041**

Medida 1/2"

EAN 8435195817331

Cód. **1054**

Medida 1/2"

EAN 8435195821550

CAÑO GIRATORIO

FUNDIDO A PARED



Cód. **1044**

Medida 1/2"

EAN 8435195817324

Cód. **1045**

Medida 1/2"

EAN 8435195827996

FUNDIDO A ENCIMERA

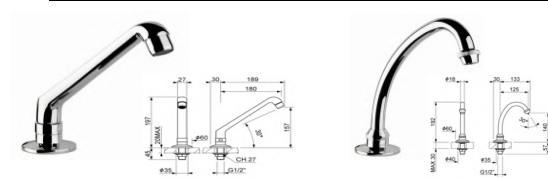

Cód. **1042**

Medida 1/2"

EAN 8435195817348

Cód. **1043**

Medida 1/2"

EAN 8435195817355



GRIFERÍA MEDICAL

Grifos mural		28
Grifos lavabo		28
Grifos fregadero		29



GRIFERÍA MEDICAL

GRIFO MURAL MEDICAL CAÑO BAJO

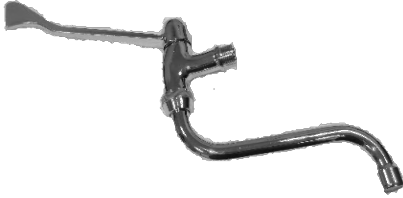

Código	Medida	Caja	EAN
25551	1/2"	1	8435195825268

- Caño bajo giratorio tubo de latón.
- Cuerpo fabricado en latón según EN 1982 y cromado.
- Entrada M 1/2.

GRIFO MURAL MEDICAL 1/2"



Código	Medida	Caja	EAN
25555	1/2"	1	8435195825305

- Cuerpo fabricado en latón según EN 1982 y cromado.
- Entrada M 1/2.

GRIFO LAVABO MEDICAL



Código	Medida	Caja	EAN
25556	1/2"	1	8435195825312

- Cuerpo fabricado en latón según EN 1982 y cromado.
- Atomizador de latón

MONOMANDO FREGADERO MEDICAL

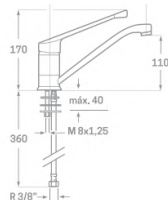
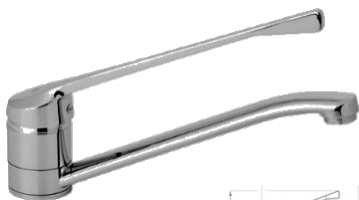

Código	Medida	Caja	EAN
25552	-	1	8435195825275

- Caño alto orientable tubo de latón.
- Cartucho cerámico de 40 mm.
- Conexiones Aenor H3/8*35 cm.
- Atomizador de latón M 24/100.

GRIFERÍA MEDICAL

MONOMANDO FREGADERO MURAL MEDICAL



Código	Medida	Caja	EAN
25553	-	1	8435195825282

- Caño bajo orientable tubo de latón.
- Cartucho cerámico de 40 mm.
- Excéntricas de latón niquelado.
- Atomizador de latón M 24/100.

MONOMANDO LAVABO MEDICAL



Código	Medida	Caja	EAN
25557	-	1	8435195825329

- Cartucho cerámico de 40 mm.
- Conexiones Aenor 10/100*3/8*35 cm.
- Atomizador de latón

PALANCA GERONTOLÓGICA - MEDICAL CROMO









Código	Medida	Caja	EAN
1105	-	1	8435195834512

	Código	Descripción	EAN
Recambio	1110	Cartucho 40 mm.	8435195821116



GRIFERÍA SERIE

Grifería serie CATI		32
Grifería serie NICE		33
Grifería serie MINIMALISTA		34
Grifería serie ESFERA		35
Grifería TERMOSTÁTICA		36
Grifería HIGIÉNICA		37



GRIFERÍA SERIE CATI

MONOMANDO LAVABO



- Cuerpo latón pulido y cromado.
- Cartucho cerámico de 40 mm.
- Conexiones Aenor 10/100*3/8*35 cm.
- Atomizador de latón M 24/100.

Cód. **1170**

Caja: 1 ud.

EAN 8435195817324

MONOMANDO BIDET



- Cuerpo latón pulido y cromado.
- Cartucho cerámico de 40 mm.
- Conexiones Aenor 10/100*3/8*35 cm.
- Atomizador de latón M 24/100.

Cód. **1171**

Caja: 1 ud.

EAN 8435195815542

MONOMANDO DUCHA



- Cuerpo latón pulido y cromado.
- Cartucho cerámico de 40 mm.
- Excéntricas de latón niquelado.
- Incluye mango de ducha, soporte y flexo.

Cód. **1172**

Caja: 1 ud.

EAN 8435195815559

MONOMANDO BAÑO



- Cuerpo latón pulido y cromado.
- Cartucho cerámico de 40 mm.
- Excéntricas de latón niquelado.
- Incluye mango de ducha, soporte y flexo.
- Atomizador de latón M 24/100.

Cód. **1173**

Caja: 1 ud.

EAN 8435195815566

	Código	Descripción	EAN
Recambio	1110	Cartucho 40 mm.	8435195821116

GRIFERÍA SERIE NICE

MONOMANDO LAVABO



- Cuerpo latón pulido y cromado.
- Cartucho cerámico de 40 mm.
- Conexiones Aenor 10/100*3/8*35 cm.
- Atomizador antivandálico de latón M 24/100.

Cód. **1201**

Caja: 1 ud.

EAN 8435195847758

MONOMANDO LAVABO EMPOTRAR



- Cuerpo latón pulido y cromado.
- Cartucho cerámico de 40 mm.
- Atomizador de latón M 24/100.

Cód. **1202**

Caja: 1 ud.

EAN 8435195847765

MONOMANDO BIDET



- Cuerpo latón pulido y cromado.
- Cartucho cerámico de 40 mm.
- Conexiones Aenor 10/100*3/8*35 cm.
- Atomizador con rótula de latón M 24/100.

Cód. **1203**

Caja: 1 ud.

EAN 8435195847772

MONOMANDO DUCHA EMPOTRAR

1 vía

2 vías



- Mezclador agua fría/caliente.
- Cartucho cerámico de 40 mm.

Cód. **1204**

Caja: 1 ud.

EAN 8435195847789

Cód. **1205**

Caja: 1 ud.

EAN 8435195847796

MONOMANDO BAÑO



Cód. **1206**

Caja: 1 ud.

EAN 8435195848120

MONOMANDO DUCHA



Cód. **1207**

Caja: 1 ud.

EAN 8435195848137



GRIFERÍA SERIE MINIMALISTA

MONOMANDO LAVABO

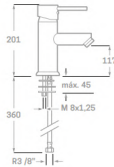

- Cuerpo latón pulido y cromado.
- Cartucho cerámico de 40 mm.
- Conexiones Aenor 10/100*3/8*35 cm.
- Atomizador de latón M 24/100.

Cód. **1180**

Caja: 1 ud.

EAN 8435195815580

MONOMANDO BIDET



- Cuerpo latón pulido y cromado.
- Cartucho cerámico de 40 mm.
- Conexiones Aenor 10/100*3/8*35 cm.
- Atomizador de latón M 24/100.

Cód. **1181**

Caja: 1 ud.

EAN 8435195815597

MONOMANDO DUCHA



- Cuerpo latón pulido y cromado.
- Cartucho cerámico de 40 mm.
- Excéntricas de latón niquelado.
- Incluye mango de ducha, soporte y flexo.

Cód. **1183**

Caja: 1 ud.

EAN 8435195815610

MONOMANDO BAÑO



- Cuerpo latón pulido y cromado.
- Cartucho cerámico de 40 mm.
- Excéntricas de latón niquelado.
- Incluye mango de ducha, soporte y flexo.
- Atomizador de latón M 24/100.

Cód. **1182**

Caja: 1 ud.

EAN 8435195815603

	Código	Descripción	EAN
Recambio	1110	Cartucho 40 mm.	8435195821116

GRIFERÍA SERIE ESFERA

MONOMANDO LAVABO



- Cuerpo latón pulido y cromado.
- Monturas cerámica de 1/2 vuelta.
- Conexiones Aenor 10/100*3/8*35 cm.
- Atomizador de latón M 24/100.

Cód. **1084**

Caja: 1 ud.

EAN 8435195817553

MONOMANDO BIDET



- Cuerpo latón pulido y cromado.
- Monturas cerámica de 1/2 vuelta.
- Conexiones Aenor 10/100*3/8*35 cm.
- Atomizador de latón M 24/100.

Cód. **1085**

Caja: 1 ud.

EAN 8435195817560

MONOMANDO DUCHA



- Cuerpo latón pulido y cromado.
- Monturas cerámica de 1/2 vuelta.
- Excéntricas de latón niquelado.
- Incluye mango de ducha, soporte y flexo.

Cód. **1087**

Caja: 1 ud.

EAN 8435195817584

MONOMANDO BAÑO



- Cuerpo latón pulido y cromado.
- Monturas cerámica de 1/2 vuelta.
- Excéntricas de latón niquelado.
- Incluye mango de ducha, soporte y flexo.

Cód. **1086**

Caja: 1 ud.

EAN 8435195817577

	Código	Descripción	EAN
Recambio	1080	Montura cerámica 1/2"	8435195834116



GRIFERÍA SERIE TERMOSTÁTICA

MONOMANDO DUCHA



- Cuerpo latón pulido y cromado.
- Cartucho termostático de latón.
- Regulación automática de temperatura a 38 ° C
- Incluye mango de ducha, soporte y flexo.

Cód. **1187**

Caja: 1 ud.

EAN 8435195817607

MONOMANDO BAÑO



- Cuerpo latón pulido y cromado.
- Cartucho termostático de latón.
- Regulación automática de temperatura a 38 ° C
- Incluye mango de ducha, soporte y flexo.

Cód. **1189**

Caja: 1 ud.

EAN 8435195817621

	Código	Descripción	EAN
Recambio	1111	Cartucho termostático	8435195834123

GRIFERÍA HIGIÉNICA WC/BIDET

GRIFO WC/BIDET MANGO ABS



- Agua fría y caliente.
- Flexo WC/Bidet PVC 1,2m.
- Mango WC/Bidet ABS.

Cód. **1301**

Caja: 1 ud.

EAN 8435195847802

MONOMANDO BAÑO



- Agua fría y caliente.
- Flexo WC/Bidet PVC 1,2m.
- Mango WC/Bidet latón.

Cód. **1302**

Caja: 1 ud.

EAN 8435195847819

MANGO ABS GRIFO HIGIÉNICO



Cód. **1303**

Caja: 1 ud.

EAN 8435195847826

MANGO LATÓN GRIFO HIGIÉNICO



Cód. **1304**

Caja: 1 ud.

EAN 8435195847833



COLUMNAS DE DUCHA

Columnas de ducha



40



COLUMNAS DE DUCHA

COLUMNA DUCHA IRIS TELESCÓPICA

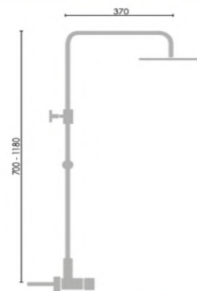

Código	Medida	Caja	EAN
78301	-	1	8435195828191

- Conjunto de barra, rociador y ducha.
- Tubo telescópico de 700 a 1180 mm.
- Barra Ø 25 mm.
- Distribuidor, soporte ajustable.
- Flexo de 1,7 m. y conexión 0,70 m.
- Rociador de acero.
- Incluye mango de ducha 3 posiciones.

COLUMNA DUCHA IRIS CUADRADO

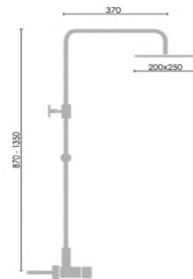

Código	Medida	Caja	EAN
78302	-	1	8435195828207

- Grifería monomando.
- Barra extensible de latón de 870 a 1350 mm.
- Rociador antical cuadrado en acero de 200 x 200 mm.
- Flexo de acero reforzado 1,5 - 2m.
- Incluye mango de ducha 1 posición.

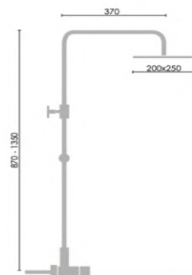
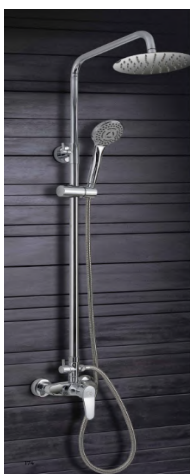

COLUMNA DUCHA IRIS REDONDO



Código	Medida	Caja	EAN
78303	-	1	8435195828214

- Grifería monomando.
- Barra extensible de latón de 870 a 1350 mm.
- Rociador antical redondo en acero de 200 mm.
- Flexo de acero reforzado 1,5 - 2m.
- Incluye mango de ducha 3 posiciones.

GRIFERÍA DE FREGADERO

Monomandos		42
Baterías		45
Monoblocs		46



GRIFERÍA DE FREGADERO

Monomandos

MONOMANDO FREGADERO CAÑO HORIZONTAL



Código	Medida	Caja	EAN
1174	-	1	8435195821475

- Caño tubo de latón conformado.
- Cartucho cerámico de 40 mm.
- Conexiones Aenor 10/100*3/8*35 cm.
- Atomizador de latón M 24/100.

MONOMANDO FREGADERO VERTICAL CAÑO TUBO



Código	Medida	Caja	EAN
1175	-	1	8435195815573

- Caño tubo de latón conformado.
- Cartucho cerámico de 40 mm.
- Conexiones Aenor 10/100*3/8*35 cm.
- Atomizador de latón M 24/100.

MONOMANDO FREGADERO VERTICAL CAÑO FUNDIDO



Código	Medida	Caja	EAN
1076	-	1	8435195825602

- Caño fundido de latón.
- Cartucho cerámico de 40 mm.
- Conexiones Aenor 10/100*3/8*35 cm.
- Atomizador de latón M 24/100.

MONOMANDO FREGADERO VERTICAL CAÑO CISNE



Código	Medida	Caja	EAN
1194	-	1	8435195825596

- Caño tubo de latón Ø 24 mm.
- Cartucho cerámico de 40 mm.
- Conexiones Aenor 10/100*3/8*35 cm.
- Atomizador de latón H 22/100.

	Código	Descripción	EAN
Recambio	1110	Cartucho 40 mm.	8435195821116

GRIFERÍA DE FREGADERO

Monomandos

MONOMANDO FREGADERO EXTRAÍBLE CAÑO BAJO



Código	Medida	Caja	EAN
1177	-	1	8435195825619

- Cartucho cerámico de 40 mm.
- Conexiones Aenor 10/100*3/8*35 cm.
- Mango extraíble de dos posiciones.

MONOMANDO FREGADERO EXTRAÍBLE CAÑO ALTO



Código	Medida	Caja	EAN
1196	-	1	8435195820485

- Cartucho cerámico de 40 mm.
- Conexiones Aenor 10/100*3/8*35 cm.
- Mango extraíble de dos posiciones.

MONOMANDO FREGADERO OSMOSIS



Código	Medida	Caja	EAN
1179	-	1	8435195828351

- Caño tubo de latón.
- Cartucho cerámico de 35 mm.
- Conexiones Aenor 10/100*3/8*35 cm.
- Atomizador de latón M 24/100 para mezclador
- Atomizador de latón M 18/100 para osmotizador.

MONOMANDO FREGADERO MINIMALISTA



Código	Medida	Caja	EAN
1184	-	1	8435195815627

- Caño tubo de latón Ø 24 mm.
- Cartucho cerámico de 40 mm.
- Conexiones Aenor 10/100*3/8*35 cm.

	Código	Descripción	EAN
Recambio	1110	Cartucho 40 mm.	8435195821116
	78005	Mango extraíble	8435195825862
	1112	Cartucho 35 mm.	8435195821130



GRIFERÍA DE FREGADERO

Monomandos

MONOMANDO FREGADERO MURAL CAÑO ALTO TUBO



Código	Medida	Caja	EAN
1176	-	1	8435195825626

- Caño tubo de latón conformado.
- Cuerpo latón pulido y cromado.
- Cartucho cerámico de 40 mm.
- Atomizador de latón M 24/100.

MONOMANDO FREGADERO MURAL CAÑO ALTO FUNDIDO



Código	Medida	Caja	EAN
1102	-	1	8435195834130

- Caño fundido de latón.
- Cuerpo latón pulido y cromado.
- Cartucho cerámico de 40 mm.
- Atomizador de latón M 24/100.

MONOMANDO FREGADERO MURAL CAÑO BAJO TUBO



Código	Medida	Caja	EAN
1178	-	1	8435195825633

- Cuerpo latón pulido y cromado.
- Cartucho cerámico de 40 mm.
- Atomizador de latón M 24/100.

	Código	Descripción	EAN
Recambio	1110	Cartucho 40 mm.	8435195821116

GRIFERÍA DE FREGADERO

Baterías

BATERÍA FREGADERO CAÑO BAJO



Código	Medida	Caja	EAN
99071	11 cm.	1	8435195825640
99072	16 cm.	1	8435195825657

- Caño giratorio Ø 18 mm. Y longitud 22 cm. con filtro atomizador.
- Monturas **cierre cerámico**.

BATERÍA FREGADERO CAÑO ALTO



Código	Medida	Caja	EAN
99090	11 cm.	1	8435195817652
99089	16 cm.	1	8435195817669

- Caño giratorio Ø 18 mm. Y longitud 21 cm. con filtro atomizador.
- Monturas **cierre cerámico**.

BATERÍA FREGADERO CAÑO ALTO MONTURA SOLETA



Código	Medida	Caja	EAN
99073	11 cm.	1	8435195828368
99074	16 cm.	1	8435195828375

- Caño giratorio Ø 18 mm. Y longitud 22 cm. con filtro atomizador.
- Monturas **cierre soleta**.

BATERÍA FREGADERO CAÑO CORTO



Código	Medida	Caja	EAN
99097	11 cm.	1	8435195817676
99098	16 cm.	1	8435195817683

- Caño giratorio Ø 18 mm. Y longitud 16 cm. con filtro atomizador.
- Monturas **cierre cerámico**.

	Código	Descripción	EAN
Recambio	1135	Montura cerámica	8435195832228
	78211	Caño bajo	8435195832266
	78210	Caño alto	8435195832259
	78204	Caño corto	8435195832242
	19045	Volante metálico, tapa e índice	8435195832235



GRIFERÍA DE FREGADERO

Monoblocs

MONOBLOC FREGADERO CAÑO TUBO





Código	Medida	Caja	EAN
1096	-	1	8435195817690

- Caño tubo de latón Ø 24 mm.
- Monturas **cierre cerámico**.
- Conexiones Aenor 10/100*3/8*35 cm.

	Código	Descripción	EAN
Recambio	1135	Montura cerámica	8435195832228
	19045	Volante metálico, tapa e índice	8435195832235

GRIFERÍA DE UN AGUA

Monomandos		48
Baterías		50
Office		51



GRIFERÍA DE UN AGUA

Monomandos

MONOMANDO MURAL UN AGUA CAÑO VERTICAL



Código	Medida	Caja	EAN
1094	1/2"	1	8435195833973

- Caño tubo vertical giratorio.
- Cartucho cerámico de 25 mm.
- Atomizador de latón

MONOMANDO MURAL UN AGUA CAÑO VERTICAL



Código	Medida	Caja	EAN
1107	1/2"	1	8435195834154

- Caño tubo vertical giratorio.
- Cartucho cerámico de 25 mm.
- Atomizador de latón H 22/100.

MONOMANDO MURAL UN AGUA CAÑO HORIZONTAL



Código	Medida	Caja	EAN
1099	1/2"	1	8435195817645

- Caño tubo recto giratorio de 22 cm.
- Cartucho cerámico de 25 mm.
- Atomizador de latón H 22/100.

MONOMANDO FREGADERO UN AGUA CAÑO VERTICAL



Código	Medida	Caja	EAN
1103	1/2"	1	8435195834147

- Caño tubo vertical giratorio.
- Cartucho cerámico de 25 mm.
- Atomizador de latón H 22/100.

	Código	Descripción	EAN
Recambio	1074	Cartucho 25 mm.	8435195827972
	78216	Caño vertical	8435195847857
	78212	Caño recto	8435195828382

GRIFERÍA DE UN AGUA

Monomandos

MONOMANDO MURAL LAVABO UN AGUA



Código	Medida	Caja	EAN
1072	1/2"	1	8435195828412

- Cartucho cerámico de 25 mm.
- Entrada de agua rosca gas macho 1/2"
- Atomizador de latón M 24/100.

MONOMANDO LAVABO UN AGUA



Código	Medida	Caja	EAN
1071	1/2"	1	8435195828405

- Cartucho cerámico de 25 mm.
- Entrada de agua rosca gas macho 1/2"
- Atomizador de latón M 24/100.

	Código	Descripción	EAN
Recambio	1078	Cartucho 25 mm.	8435195834161



GRIFERÍA DE UN AGUA

Baterías

GRIFO MURAL UN AGUA CAÑO ALTO HORIZONTAL



Código	Medida	Caja	EAN
1069	1/2"	1	8435195817638

- Caño giratorio Ø 18 mm. Y longitud 22 cm. con filtro atomizador.
- Monturas **cierre cerámico**.
- Volante metálico con índice azul.
- Entrada M 1/2"

GRIFO MURAL UN AGUA CAÑO BAJO HORIZONTAL

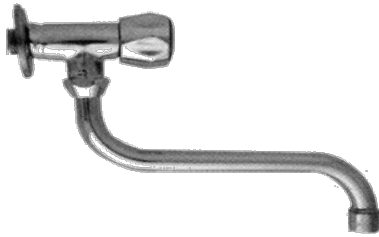

Código	Medida	Caja	EAN
1068	1/2"	1	8435195827927

- Caño giratorio Ø 18 mm. con filtro atomizador.
- Monturas **cierre cerámico**.
- Volante metálico con índice azul.
- Entrada M 1/2"

GRIFO UN AGUA CAÑO VERTICAL



Código	Medida	Caja	EAN
1098	1/2"	1	8435195817713

- Caño giratorio Ø 18 mm. y longitud 26 cm. con filtro atomizador.
- Monturas **cierre cerámico**.
- Volante metálico con índice azul.
- Entrada M 1/2"

	Código	Descripción	EAN
Recambio	18510	Montura cerámica 1069-1068	8435195832228
	1135	Montura cerámica 1098	8435195832228
	78213	Caño alto	8435195828399
	78211	Caño bajo	8435195832266
	78215	Caño vertical	8435195834178
	19045	Volante metálico, tapa e índice	8435195832235

GRIFERÍA DE UN AGUA

Office

GRIFO LAVADORA SENCILLO



	Código	Medida	Caja	EAN
Soleta	25004	1/2" x 3/4"	10	8435195801774
Cerámico	25007	1/2" x 3/4"	10	8435195801781

- Entrada M 1/2" - Salida M 3/4"
- Volante metálico con índice azul.

GRIFO LAVADORA DOBLE TIPO "Y"

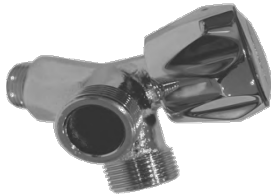

	Código	Medida	Caja	EAN
Soleta	25526	1/2" x 3/4" x 3/4"	10	8435195820331

- Entrada M 1/2" - 2 Salidas M 3/4"
- Volante metálico con índice azul.

GRIFO LAVADORA DOBLE



	Código	Medida	Caja	EAN
Soleta	25006	1/2" x 3/4"	10	8435195801804
Cerámico	25008	1/2" x 3/4"	10	8435195801811

- Entrada M 1/2" - Salida M 3/4"
- Volantes metálicos con índices azules.

GRIFO LAVAVAJILLAS DOBLE



	Código	Medida	Caja	EAN
Soleta	25010	1/2" x 3/4" x 3/4"	10	8435195801835
Cerámico	25011	1/2" x 3/4" x 3/4"	10	8435195801842

- Entrada M 1/2" - 2 Salidas M 3/4"
- Volantes metálicos con índices azules.

	Código	Descripción	EAN
Recambio	1133	Montura soleta	8435195827972
	1134	Montura cerámica	8435195832211



GRIFERÍA DE UN AGUA

Office

PLACA ATORNILLAR CROMADA



Código	Medida	Caja	EAN
25519	M-H 1/2"	10	8435195801989
25521	H-H 1/2"	10	8435195802009

"Y" BIFURCACIÓN SALIDA DOBLE



Código	Medida	Caja	EAN
25509	3/4"	10	8435195834185

- Entrada H 3/4" - Salidas M 3/4" M 3/4"
- Fabricado en latón y cromado.

"Y" BIFURCACIÓN SALIDA DOBLE



Código	Medida	Caja	EAN
58535	3/4"	10	8435195834192

- Entrada H 3/4" - Salidas M 3/4" M 3/4"
- Fabricado en ABS con tuerna de nylon.
- Junta de silicona.

CONJUNTO GRIFO ADAPTADOR



	Código	Medida	Caja	EAN
Conjunto	25507	3/4" x 3/4" x 3/4"	10	8435195801897
Adaptador	25508	3/4" x 3/4"	10	8435195801903

- Montura cierre soleta.
- Volante metálico con índice azul.

GRIFERÍA DE UN AGUA

Office

GRIFO MURAL LAVABO CORTO



	Código	Medida	Caja	EAN
Soleta	24005	1/2 x 14 cm.	10	8435195801576
Cerámico	24003	1/2 x 14 cm.	10	8435195801552

- Entrada M 1/2".
- Salida con rompe-aguas.
- Volante metálico con índice azul.

GRIFO MURAL LAVABO LARGO



	Código	Medida	Caja	EAN
Soleta	24006	1/2 x 17 cm.	10	8435195801583
Cerámico	24004	1/2 x 17 cm.	10	8435195801569

- Entrada M 1/2".
- Salida con rompe-aguas.
- Volante metálico con índice azul.

GRIFO MURAL LAVABO



	Código	Medida	Caja	EAN
Cerámico	24007	1/2"	10	8435195801590

- Entrada M 1/2".
- Volante metálico con índice azul.

GRIFO MURAL LAVABO ITÁLICO



	Código	Medida	Caja	EAN
Corto	25503	1/2" x 12 cm.	10	8435195801859
Largo	25504	1/2" x 16 cm.	10	8435195801866

- Montura **cierre soleta** 1/2 vuelta.
- Entrada M 1/2".

	Código	Descripción	EAN
Recambio	1133	Montura soleta	8435195827972
	1134	Montura cerámica	8435195832211
	19020	Montura itálico	8435195834222



GRIFERÍA DE UN AGUA

Office

JUEGO GRIFOS DE BIDET



- Montura **cierre soleta**.
- Entrada M 1/2"
- Volante metálico con un índice azul y un índice rojo.

Cód. 24010

Caja: 2 uds.

EAN 8435195828238

JUEGO GRIFOS DE LAVABO



- Montura **cierre cerámico**.
- Entrada M 1/2"
- Volante metálico con un índice azul y un índice rojo.
- Atomizador M22/100

Cód. 24011

Caja: 2 uds.

EAN 8435195801613

	Código	Descripción	EAN
Recambio	79005	Atomizador M 22/100	8435195834208
	24008	Montura cerámica	8435195834218

RECAMBIOS DE GRIFERÍA

Recambios de grifería



56

RECAMBIOS GRIFERÍA

PALANCAS



Código	Descripción	EAN
1105	Palanca medical larga	8435195834512

CARTUCHOS



Código	Descripción	EAN
1110	Cartucho 40 mm. Sin distribuidor	8435195821116
1111	Cartucho 40 mm. Con distribuidor	8435195821123
11111	Cartucho termostático	8435195834123
1112	Cartucho 35 mm. Sin distribuidor	8435195821130
1113	Cartucho 35 mm. Con distribuidor	8435195825886
1074	Cartucho 25 mm.	8435195827972
1078	Cartucho 25 mm. - Art. 1071 - 1072	8435195834161

MONTURAS



Código	Descripción	EAN
1080	Montura cerámica 1/2" - Serie Esfera	8435195834116
1135	Montura cerámica - Baterías	8435195832228
18510	Montura cerámica - Art. 1068 - 1069	8435195834727
1133	Montura soleta - Grifos lavadora/lavavajillas	8435195827972
1134	Montura cerámica - Grifos lavadora/lavavajillas	8435195832211
24008	Montura cerámica - Grifos lavabo	8435195834218
19020	Montura grifo itálico	8435195834222

MANGOS



Código	Descripción	EAN
78005	Mango extraíble	8435195825862

CAÑOS



Código	Descripción	EAN
78211	Caño bajo batería	8435195832266
78210	Caño alto batería	8435195832259
78204	Caño corto batería	8435195832242
78213	Caño alto - Art. 1069	8435195828399
78215	Caño vertical - Art. 1098	8435195834178
78216	Caño vertical - Art. 1094	8435195847857

ACCESORIOS



Código	Descripción	EAN
19045	Volante metálico, tapa e índice	8435195832235
79005	Atomizador grifo lavabo	8435195834208
78013	Tuerca pestaña 3/4"	8435195832273
99095	Pestaña batería	8435195832280
99096	Tuerca caño 3/4"	8435195832297

ACCESORIOS DE GRIFERÍA

Fijaciones y excéntricas		58
Conexiones flexibles		59
Accesorios grifo extraíble		59
Cartuchos y monturas		60
Atomizadores		61
Adaptadores grifería		62

ACCESORIOS GRIFERÍA

FIJACIÓN GRIFERÍA MONOMANDO 1 ESPÁRRAGO



Código	Medida	Caja	EAN
1091	8 x 70 mm.	10	8435195820386
1093	8 x 45 mm.	10	8435195832303

- Tornillo y luna en acero inoxidable.
- Incluye junta estanqueidad para base de grifo.

FIJACIÓN GRIFERÍA MONOMANDO 2 ESPÁRRAGOS



Código	Medida	Caja	EAN
1092	2 Espárragos	10	8435195821062

- Tornillo y luna en acero inoxidable.
- Incluye junta estanqueidad para base de grifo.

CONJUNTO EXCÉNTRICA Y FLORÓN



	Código	Medida	Caja	EAN
Normal	25510	3/4" x 1/2" x 10 mm.	10	8435195801934
Gigante	25511	3/4" x 1/2" x 25 mm.	10	8435195801941
Súper gigante	25523	3/4" x 1/2" x 45 mm.	10	8435195820508

- Cuerpo latón cromado.

CUERPO EXCÉNTRICA



	Código	Medida	Caja	EAN
Normal	25524	3/4" x 1/2" x 10 mm.	10	8435195821420
Gigante	25525	3/4" x 1/2" x 25 mm.	10	8435195821437
Súper gigante	25527	3/4" x 1/2" x 45 mm.	10	8435195821444

- Cuerpo latón cromado.

FLORÓN CROMADO PARA EXCÉNTRICA



	Código	Medida	Caja	EAN
Normal	25530	Ø 65 mm.	10	8435195801958
Gigante	25531	Ø 87 mm.	10	8435195801965
Súper gigante	25532	Ø 100 mm.	10	8435195820515

ACCESORIOS GRIFERÍA

JUNTA ATOMIZADOR



Código	Medida	Caja	EAN
79013	Macho 14 x 22 x 2	25	8435195823745
79017	Hembra 14 x 21 x 2	25	8435195823752

FILTRO CON REJILLA



Código	Medida	Caja	EAN
79033	Filtro + Rejilla	25	8435195828109

INSERTO PARA ESPUMANTES PLÁSTICO



Código	Medida	Caja	EAN
79039	M 24/100 - H 22/100	25	8435195825831

JUEGO CONEXIÓN FLEXIBLE GRIFERÍA



Código	Medida	Caja	EAN
56501	H 3/8" x M 10/100x30 cm.	30	8435195806762
56503	H 3/8" x M 10/100x40 cm.	40	8435195806786
56504	H 3/8" x M 10/100x50 cm.	50	8435195806793

• Malla exterior acero inoxidable e interior EPDM atóxico.

FLEXO GRIFO FREGADERO EXTRAÍBLE



Código	Medida	Caja	EAN
50503	H 1/2" x M 3/8" x 1,25 m.	1	8435195825848
50507	H 1/2" x M 15/100	1	8435195825855

• Malla exterior acero inoxidable e interior EPDM atóxico.

FLEXO DE ACERO EXTENSIBLE



Código	Medida	Caja	EAN
50003	M 3/8 x H 1/2 x 1,70 m.	10	8435195825916

• Malla exterior acero inoxidable e interior EPDM atóxico.
• Longitud: 1,70 m. a 2,20 m.

ACCESORIOS GRIFERÍA

MANGO DUCHA FREGADERO EXTRAÍBLE



Código	Medida	Caja	EAN
78005	-	1	8435195825862

PLOMADA GRIFO FREGADERO EXTRAÍBLE



Código	Medida	Caja	EAN
50510	-	1	8435195825879

CARTUCHO MONOMANDO



Código	Medida	Caja	EAN
1110	Ø 40 mm.Sin distribuidor	1	8435195821116
1111	40 mm.Con distribuidor	1	8435195821123
1112	Ø 35 mm.Sin distribuidor	1	8435195821130
1113	35 mm.Con distribuidor	1	8435195825886

INVERSOR MONOMANDO



Código	Medida	Caja	EAN
1120	-	1	8435195821147

ENGANCHE PORTACADENAS



Código	Medida	Caja	EAN
1090	21 x 5,5	10	8435195825893

MONTURA CERÁMICA



Código	Medida	Caja	EAN
1130	90° x 1/2	1	8435195821178
1131	180° x 1/2	1	8435195821185
1134	Grifo lavadora	1	8435195832211
1135	Batería de fregadero	1	8435195832228

MONTURA SOLETA



Código	Medida	Caja	EAN
1132	8 x 20 x 1/2	1	8435195825909
1133	Grifo lavadora	1	8435195834239

ACCESORIOS GRIFERÍA

FILTRO ATOMIZADOR



	Código	Medida	Caja	EAN
Bolsa	79004	Macho 18/100	100	8435195832310
	79024	Macho 20/100	100	8435195825565
	79005	Macho 22/100	100	8435195834208
	79001	Macho 24/100	100	8435195825534
	79003	Macho 28/100	100	8435195825558
	79006	Hembra 16/100	100	8435195834246
	79023	Hembra 18/100	100	8435195825770
	79007	Hembra 20/100	100	8435195842678
	79002	Hembra 22/100	100	8435195825541

	Código	Medida	Caja	EAN
Blister	79010	Macho 24/100	100	8435195812671
	79012	Macho 28/100	100	8435195812718
	79011	Hembra 22/100	100	8435195812695

	Código	Medida	Caja	EAN
Oro / Bolsa	79020	Macho 24/100	100	8435195812688
	79022	Macho 28/100	100	8435195812725
	79021	Hembra 22/100	100	8435195812701

- Fabricado en latón cromado. Disponible en color oro.
- Rejilla interior de acero inoxidable.

FILTRO ATOMIZADOR ECONOMIZADOR



	Código	Medida	Caja	EAN
Blister	79030	Macho 24/100	25	8435195821376
	79031	Hembra 22/100	25	8435195821383

	Código	Medida	Caja	EAN
Blister	79032	Limitador caudal ducha 1/2"	25	8435195821451

- Fabricado en latón cromado.
- Reduce el caudal de agua un 50% aprox.

FILTRO ATOMIZADOR CON RÓTULA



	Código	Medida	Caja	EAN
Bolsa	79015	Macho 24/100	10	8435195812749
	79016	Hembra 22/100	10	8435195812763

	Código	Medida	Caja	EAN
Oro / Bolsa	79025	Macho 24/100	10	8435195812756
	79026	Hembra 22/100	10	8435195812770

- Fabricado en latón cromado. Disponible en color oro.
- Rejilla interior de acero inoxidable.

ACCESORIOS GRIFERÍA

ESPUMANTE FLEXIBLE



Blister	Código	Medida	Caja	EAN
Latón	79035	H 22/100 - M 24/100	20	8435195825428
ABS	79036	H 22/100 - M 24/100	20	8435195823691

ESPUMANTE FLEXIBLE 2 POSICIONES



Blister	Código	Medida	Caja	EAN
Blister	79038	H 22/100 ABS	20	8435195825794

INSERTO PARA ESPUMANTE



Blister	Código	Medida	Caja	EAN
ABS	79039	M 24/100 - H 22/100	20	8435195825831
Latón	79040	M 24/100 - H 22/100	20	8435195842692

ECONOMIZADOR 2 POSICIONES CON RÓTULA



Blister	Código	Medida	Caja	EAN
Latón	79042	M 24/100	20	8435195825176
ABS	79041	H 22/100	20	8435195823738

- 2 posiciones: atomizador y rociador.
- Orientable.

ADAPTADOR GRIFERÍA M 24/100



Blister	Código	Medida	Caja	EAN
Blister	79046	M 24/100 x M 3/4"	20	8435195825800

- Filtro atomizador en el interior.

ADAPTADOR GRIFERÍA H 22/100



Blister	Código	Medida	Caja	EAN
Blister	79047	H 22/100 x M 3/4"	25	8435195825817

- Filtro atomizador en el interior.







ADAPTADOR GRIFERÍA ENCHUFE RÁPIDO



Blister	Código	Medida	Caja	EAN
Blister	79048	M 24/100	10	8435195842715

- Filtro atomizador en el interior.

COMPLEMENTOS DE BAÑO

Mangos de ducha		64
Flexos de ducha		67
Rociadores		68
Brazos y barras de ducha		70
Soportes de ducha		71
Barras de seguridad		72

COMPLEMENTOS DE BAÑO

Mangos de ducha

MANGO DE DUCHA CRIS



Código	Descripción	Caja	EAN
75001	Blanco	10	8435195812312
75002	Negro	10	8435195812329

- Una única posición.
- Empaquetado en bolsa individual.

MANGO DE DUCHA GOLF



Código	Descripción	Caja	EAN
75011	Blanco	10	8435195812336

- Una única posición.
- Empaquetado en bolsa individual.

MANGO DE DUCHA BOSTON



Código	Descripción	Caja	EAN
76001	Blanco	10	8435195812343
76002	Negro	10	8435195812350

- Una única posición.
- Empaquetado en bolsa individual.

MANGO DE DUCHA FORMENTOR



Código	Descripción	Caja	EAN
77001	Blanco	10	8435195812367
77003	Cromo	10	8435195812374

- Una única posición.
- Empaquetado en bolsa individual.

MANGO DE DUCHA TER



Código	Descripción	Caja	EAN
78001	Blanco	10	8435195812404
78002	Negro	10	8435195812411
78003	Cromo	10	8435195812428

- Una única posición.
- Empaquetado en bolsa individual.

COMPLEMENTOS DE BAÑO

Mangos de ducha

MANGO DE DUCHA ALCUDIA



Código	Descripción	Caja	EAN
78101	Blanco	10	8435195812435
78103	Negro	10	8435195812459
78102	Cromo	10	8435195812442

- Una única posición.
- Con membrana antical.
- Empaquetado en bolsa individual.

MANGO DE DUCHA TOSCANA



Código	Descripción	Caja	EAN
78105	Cromo	10	8435195832327

- Una única posición.
- Con membrana antical.
- Empaquetado en caja individual.

MANGO DE DUCHA VIENA



Código	Descripción	Caja	EAN
78112	Blanco y cromo	10	8435195847734

- Una única posición.
- Con membrana antical.
- Empaquetado en caja individual.

MANGO DE DUCHA MINIMALISTA

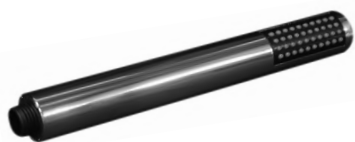

Código	Descripción	Caja	EAN
78106	Cromo	10	8435195820195

- Una única posición.
- Empaquetado en bolsa individual.

MANGO DE DUCHA MINIMALISTA CUADRADO



Código	Descripción	Caja	EAN
78111	Cromo	10	8435195842609

- Una única posición.
- Empaquetado en bolsa individual.



COMPLEMENTOS DE BAÑO

Mangos de ducha

MANGO DE DUCHA 2 POSICIONES



- Dos posiciones, con membrana antical.

Cód. **78104**

Caja: 1 ud.

EAN 8435195842586

MANGO DE DUCHA 5 POSICIONES



- Cinco posiciones, con membrana antical.

Cód. **78107**

Caja: 1 ud.

EAN 8435195820201

MANGO DE DUCHA PISA



- Cuatro posiciones, con membrana antical.

Cód. **78108**

Caja: 1 ud.

EAN 8435195812466

MANGO DE DUCHA PALMA



- Cinco posiciones, con membrana antical.

Cód. **78113**

Caja: 1 ud.

EAN 8435195847741

SET DE DUCHA CLARA



Código	Descripción	Caja	EAN
78109	-	1	8435195832334

- Manual cinco posiciones con membrana antical.
- Soporte cónico cromado.
- Flexo cromado reforzado de 1,70 m.

CODO DUCHA CROMADO



Código	Descripción	Caja	EAN
77002	Latón	10	8435195812381
77005	ABS	25	8435195812398

COMPLEMENTOS DE BAÑO

Flexos de ducha

FLEXO DE ACERO TUERCA GRAFILADA



Código	Medida	Caja	EAN
50001	1,5 m.	10	8435195806557
50002	2 m.	10	8435195806564

- Doble engatillado reforzado.
- Tuercas hexagonales rosca hembra 1/2".
- Tubo interior EPDM.

FLEXO DE ACERO TUERCA CÓNICA



Código	Medida	Caja	EAN
50513	1,20 m.	10	8435195839555
50501	1,5 m.	10	8435195806571
50508	1,75 m.	10	8435195806588
50502	2 m.	10	8435195806595

- Doble engatillado reforzado.
- Tuerca cónica y tuerca hexagonal rosca hembra 1/2".
- Tubo interior EPDM.

FLEXO DE ACERO EXTENSIBLE



Código	Medida	Caja	EAN
50504	1,75 m. a 2,40 m.	10	8435195806601

- Doble engatillado reforzado.
- Tuerca cónica y tuerca hexagonal rosca hembra 1/2".
- Tubo interior EPDM.

FLEXO DE PVC TUERCA CÓNICA



	Código	Medida	Caja	EAN
Blanco	52001	1,5 m.	10	8435195806649



	Código	Medida	Caja	EAN
Negro y cromo	52003	1,5 m.	10	8435195827934
	52004	2 m.	10	8435195827941

- Tuerca cónica y tuerca hexagonal rosca hembra 1/2".



COMPLEMENTOS DE BAÑO

Rociadores

ROCIADOR DUCHA



Código	Medida	Caja	EAN
78402	1/2" x Ø 60 mm.	20	8435195812527

• Fabricado en latón cromado.



Código	Medida	Caja	EAN
78404	1/2" x Ø 90 mm.	20	8435195812534

• Fabricado en latón cromado.



Código	Medida	Caja	EAN
78403	1/2" x Ø 50 mm.	20	8435195812541

• Fabricado en ABS blanco.



Código	Medida	Caja	EAN
78407	1/2" Pared	10	8435195825930

• Fabricado en latón cromado.

• Antivandálico.

ROCIADOR DUCHA CON RÓTULA LATÓN



• Fabricado en latón. 1/2" x Ø 43 mm.

Cód. 79018

Caja: 1 0 uds.

EAN 8435195824629

ROCIADOR DUCHA CON RÓTULA ABS



• Fabricado en ABS. 1/2" x Ø 60 mm.

Cód. 79014

Caja: 1 0 uds.

EAN 8435195812664

ROCIADOR DUCHA CLARA 5 POSICIONES



• Fabricado en ABS. 1/2" x Ø 80 mm.

Cód. 78408

Caja: 1 0 uds.

EAN 8435195820225

ROCIADOR DUCHA CLARA 3 POSICIONES



• Fabricado en ABS. 1/2" x Ø 60 mm.

Cód. 78411

Caja: 1 0 uds.

EAN 8435195825947

COMPLEMENTOS DE BAÑO

Rociadores

ROCIADOR DUCHA REDONDO ABS



- 1/2" x Ø 200 mm.
- Fabricado en ABS cromado, con rótula en latón.
- Membrana antical.
- Empaquetado en caja blanca individual.

Cód. **78409**

Caja: 1 0 uds.

EAN 8435195820232

ROCIADOR DUCHA CUADRADO ABS



- 1/2" x Ø 200 mm.
- Fabricado en ABS cromado, con rótula en latón.
- Membrana antical.
- Empaquetado en caja blanca individual.

Cód. **78412**

Caja: 1 0 uds.

EAN 8435195842623

ROCIADOR DUCHA REDONDO INOX.



- 1/2" x Ø 200 mm.
- Fabricado en ACERO INOX. Con rótula y rosca en latón.
- Membrana antical.
- Empaquetado en caja blanca individual.

Cód. **78413**

Caja: 1 0 uds.

EAN 8435195847659

ROCIADOR DUCHA CUADRADO INOX.



- 1/2" x Ø 200 mm.
- Fabricado en ACERO INOX. Con rótula y rosca en latón.
- Membrana antical.
- Empaquetado en caja blanca individual.

Cód. **78414**

Caja: 1 0 uds.

EAN 8435195847666

ROCIADOR DUCHA ESTRELLA

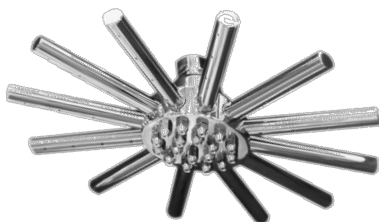

Código	Medida	Caja	EAN
78410	1/2" X Ø 220 mm.	10	8435195820249

- Fabricado en latón cromado. Rótula y rosca latón.
- Membrana antical.
- Empaquetado en caja blanca individual.



COMPLEMENTOS DE BAÑO

Brazos de ducha

BRAZO DE DUCHA



Código	Medida	Caja	EAN
78201	1/2" x 250 mm.	10	8435195812480
78202	1/2" x 300 mm.	10	8435195812497
78205	1/2" x 400 mm.	10	8435195812503

• Fabricado en acero inoxidable.

BRAZO DE DUCHA FUNDIDO



Código	Medida	Caja	EAN
78206	1/2" x 150 mm.	10	8435195825923

BRAZO DE DUCHA MANANTIAL



Código	Medida	Caja	EAN
78207	1/2" x 370 mm.	10	8435195828009

• Fabricado en acero inoxidable.

• Diametro tubo Ø 20 mm.

BRAZO DE DUCHA CURVO



Código	Medida	Caja	EAN
78209	1/2"	10	8435195820218

• Fabricado en acero inoxidable.

• Diametro tubo Ø 20 mm.

BRAZO DE DUCHA CURVO



Código	Medida	Caja	EAN
78208	1/2" x 200 mm.	10	8435195847840

• Fabricado en acero inoxidable.

• Diametro tubo Ø 20 mm.

BARRA DE DUCHA DESLIZANTE



Código	Medida	Caja	EAN
99235	Ø 28 mm. x 61 cm.	5	8435195812510

• Jabonera deslizante.

COMPLEMENTOS DE BAÑO

Soportes de ducha

SOPORTE DE DUCHA GIRATORIO



	Código	Descripción	Caja	EAN
ABS	78601	Negro	10	8435195812558
	78602	Blanco	10	8435195812565
	78603	Cromo	10	8435195812572

• Para flexos de ducha con tuerca cónica.

SOPORTE DE DUCHA GIRATORIO LUNA



	Código	Descripción	Caja	EAN
ABS	78609	Cromo	10	8435195832341

• Para flexos de ducha con tuerca cónica.

SOPORTE DE DUCHA BAYONETA

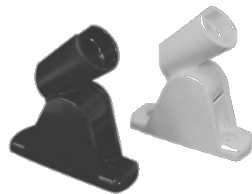

	Código	Descripción	Caja	EAN
ABS	78606	Blanco	10	8435195812596
	78604	Cromo	10	8435195825954

• Para flexos de ducha con tuerca cónica.

SOPORTE DE DUCHA HORQUILLA

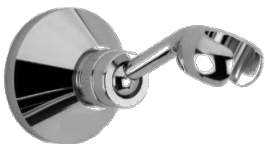

	Código	Descripción	Caja	EAN
Metal	78608	Cromo	10	8435195825978

• Para flexos de ducha con tuerca redonda o hexagonal.

SOPORTE DE DUCHA HORQUILLA CROMO



	Código	Descripción	Caja	EAN
ABS	78804	Cromo	10	8435195842630

• Para flexos de ducha con tuerca cónica.

SOPORTE DE DUCHA

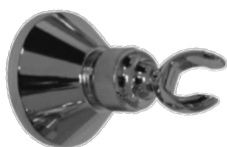

	Código	Descripción	Caja	EAN
Metal	78802	Cromo - Sin toma	10	8435195812626
ABS	78803	Cromo - Sin toma	10	8435195812633
ABS	78805	Blanco - Sin toma	10	8435195812657

• Para flexos de ducha con tuerca redonda o hexagonal.



COMPLEMENTOS DE BAÑO

Soportes de ducha

SOPORTE DE DUCHA CROMO



	Código	Descripción	Caja	EAN
ABS	78806	Cromo	10	8435195812558

- Para flexos de ducha con tuerca cónica.

CODO CON TOMA PARA FLEJO DE DUCHA



Código	Medida	Caja	EAN
78807	M 1/2" x M 1/2"	10	8435195842654

SOPORTE CON TOMA PARA FLEJO DE DUCHA



Código	Medida	Caja	EAN
78808	M 1/2" x M 1/2"	10	8435195842661



BARRA DE SEGURIDAD PARA BAÑO-DUCHA



Código	Medida	Caja	EAN
78809	30 cm.	1	8435195832358
78810	40 cm.	1	8435195832365
78811	50 cm.	1	8435195832372

- Plafones y fijaciones de latón.
- Ø 25 mm.
- Empaquetado en blister individual.

VÁLVULAS DESAGÜE

Válvulas click-clack		74
Válvulas automáticas y manuales		76
Válvulas bañera y ducha		77
Tapa orificios y tapones		79
Cadena y anillas		80



VÁLVULAS DESAGÜE

Válvulas Click-Clack

VÁLVULA DESAGÜE CLICK-CLACK LAVABO / BIDÉ ABS



Código	Medida	Caja	EAN
25561	1 1/4"	10	8435195821581

- Válvula universal **con y sin rebosadero.**
- Fabricada en ABS cromado.

VÁLVULA DESAGÜE CLICK-CLACK LAVABO / BIDÉ



Código	Medida	Caja	EAN
25500	1 1/4"	10	8435195821567

- Válvula universal **con y sin rebosadero.**
- Fabricada en latón cromado.

VÁLVULA DESAGÜE CLICK-CLACK LAVABO / BIDÉ LUJO



Código	Medida	Caja	EAN
25501	1 1/4"	10	8435195821574

- Válvula universal **con y sin rebosadero.**
- Fabricada en latón cromado.

VÁLVULA DESAGÜE CLICK-CLACK LAVABO / BIDÉ LUJO



Código	Medida	Caja	EAN
25502	1 1/4"	10	8435195825992

- Válvula universal **con y sin rebosadero.**
- Fabricada en latón cromado.

	Código	Descripción	EAN
Recambio	25528	Junta ABS	8435195825985

VÁLVULAS DESAGÜE

Válvulas Click-Clack

VÁLVULA DESAGÜE CLICK-CLACK LAVABO / BIDÉ



Código	Medida	Caja	EAN
25513	1 1/4"	10	8435195817768

- Válvula universal **sin rebosadero**.
- Fabricada en latón cromado.

VÁLVULA DESAGÜE CLICK-CLACK LAVABO / BIDÉ



Código	Medida	Caja	EAN
25515	1 1/4"	10	8435195817775

- Válvula universal **con rebosadero**.
- Fabricada en latón cromado.

VÁLVULA DESAGÜE CLICK-CLACK BAÑERA



Código	Medida	Caja	EAN
25516	1 1/2"	10	8435195817782

- Fabricada en latón cromado.

VÁLVULA DESAGÜE CLICK-CLACK BIDÉ



Código	Medida	Caja	EAN
25529	1 1/4"	10	8435195825374

- Fabricada en latón cromado.



VÁLVULAS DESAGÜE

VÁLVULA DESAGÜE AUTOMÁTICA LAVABO / BIDÉ



Código	Medida	Caja	EAN
25512	1 1/4"	2	8435195817744

• Fabricada en latón cromado.

VÁLVULA DESAGÜE AUTOMÁTICA LAVABO ABS



Código	Medida	Caja	EAN
44026	1 1/4"	2	8435195837070

• Fabricada en ABS cromado.

VÁLVULA DESAGÜE LAVABO / BIDÉ



Código	Medida	Caja	EAN
25579	1 1/4" x 70 Ø	100	8435195832488
25580	1 1/2" x 70 Ø	100	8435195832495

REJILLA FILTRO INOX PARA VÁLVULA DESAGÜE



Código	Medida	Caja	EAN
85129	68 mm.	2	8435195844825

• Filtro de acero superponible para válvulas de desagüe de Ø 70 mm.

VÁLVULAS DESAGÜE

Válvulas bañera/ducha

CONJUNTO BAÑERA CON REBOSADERO HORIZONTAL CLICK CLACK



Código	Medida	Caja	EAN
25591	1 1/2" x 40 mm. Ø	25	8435195847727

- Incluye junta reductora de Ø 40 mm. a Ø 32 mm.
- Tapón click clack.
- Salida horizontal orientable.

CONJUNTO BAÑERA CON REBOSADERO HORIZONTAL



Código	Medida	Caja	EAN
25514	1 1/2" x 40 mm. Ø	25	8435195817751

- Cadena de bolas en latón cromado.
- Incluye junta reductora de Ø 40 mm. a Ø 32 mm.

CONJUNTO BAÑERA CON REBOSADERO SIFÓNICO



Código	Medida	Caja	EAN
25563	1 1/2" x 40 mm. Ø	25	8435195835724

- Cadena de bolas en latón cromado.
- Incluye junta reductora de Ø 40 mm. a Ø 32 mm.

VÁLVULA DUCHA SIFÓNICA EXTRAPLANA SIN EMBELLECEDOR



Código	Medida	Caja	EAN
25595	1 1/2" x 40 mm. Ø	10	8435195835762

- Sin embellecedor.
- Juego de tornillos en latón.
- Sifón totalmente extraíble para facilitar su limpieza.
- Gran caudal de desagüe.

VÁLVULA DUCHA SIFÓNICA EXTRAPLANA CON EMBELLECEDOR



Código	Medida	Caja	EAN
25596	1 1/2" x 40 mm. Ø	10	8435195835779

- Con embellecedor cromado extraplano 110 mm Ø.
- Juego de tornillos en latón.
- Sifón totalmente extraíble para facilitar su limpieza.
- Gran caudal de desagüe.



VÁLVULAS DESAGÜE

Válvulas bañera/ducha

VÁLVULA PLATO DE DUCHA PARA BOTE SIFÓNICO Ø 80



Código	Medida	Caja	EAN
25582	1 1/4" x 32 mm. Ø	25	8435195832518

- Con orificio de 60 mm Ø.
- Con rejilla en acero inoxidable de 80 mm Ø.
- Salida horizontal 40 mm. Ø con reductora a 32 mm.

VÁLVULA PLATO DE DUCHA PARA BOTE SIFÓNICO Ø 115



Código	Medida	Caja	EAN
25586	1 1/2" x 40 mm. Ø	10	8435195832556

- Válvula sifónica con orificio de 90 mm. Ø.
- Con rejilla en acero inoxidable de 115 mm Ø.
- Salida horizontal 40 mm. Ø con reductora a 32 mm.

VÁLVULA PLATO DE DUCHA SIFÓNICA HORIZONTAL Ø 80



Código	Medida	Caja	EAN
25583	1 1/2" x 40 mm. Ø	25	8435195832525

- Con orificio de 60 mm. Ø.
- Con rejilla en acero inoxidable de 80 mm Ø.
- Salida orientable 40 mm. Ø con reductora a 32 mm.

VÁLVULA PLATO DE DUCHA REGISTRABLE Ø 90



Código	Medida	Caja	EAN
25584	1 1/2" x 40 mm. Ø	10	8435195832532

- Válvula sifónica con orificio de 60 mm. Ø.
- Con embellecedor champiñón en acero inoxidable de 90 mm. Ø.
- Salida horizontal 40 mm. Ø con reductora a 32 mm.

VÁLVULA PLATO DE DUCHA REGISTRABLE Ø 120



Código	Medida	Caja	EAN
25585	1 1/2" x 40 mm. Ø	10	8435195832549

- Válvula sifónica con orificio de 90 mm. Ø.
- Con embellecedor champiñón en acero inoxidable de 120 mm. Ø.
- Salida horizontal 40 mm. Ø con reductora a 32 mm.

VÁLVULAS DESAGÜE

Accesorios

TAPA ORIFICIOS LAVABO / BIDÉ



	Código	Descripción	Caja	EAN
Inox.	74501	Cromo con enganche	25	8435195812282



	Código	Descripción	Caja	EAN
ABS	74502	Blanco - Ciego	25	8435195812299
	74503	Cromo - Ciego	25	8435195812305



	Código	Descripción	Caja	EAN
ABS	74506	Blanco	25	8435195832563
	74507	Cromo	25	8435195832570



	Código	Descripción	Caja	EAN
ABS	74505	Embellecedor cromo	25	8435195828092

TAPONES DE CAUCHO



	Código	Medida	Caja	EAN
	85001	24 Ø	25	8435195814729
	85002	28 Ø	25	8435195814736
	85003	30 Ø	25	8435195814743
	85004	32 Ø	25	8435195814750
	85005	34 Ø	25	8435195814767
	85006	36 Ø	25	8435195814774
	85007	38 Ø	25	8435195814781
	85008	40 Ø	25	8435195814798
	85009	42 Ø	25	8435195814804
	85010	44 Ø	25	8435195814811
	85011	47 Ø	25	8435195814828
	85012	50 Ø	25	8435195814835
	85013	51 Ø	25	8435195814842
Universal fregadero	85014	55 Ø	25	8435195814859
	85015	61 Ø	25	8435195814866
Universal TEKA - JIMTEN	85017	46 Ø	25	8435195814880

• Con embellecedor en acero inoxidable.



VÁLVULAS DESAGÜE

Accesorios

ROLLO CADENA DE BOLAS CROMADA



Código	Medida	Caja	EAN
85101	3,2 mm. Ø x 50 m.	1	8435195815078
85102	3,8 mm. Ø x 50 m.	1	8435195815085

CADENA DE BOLAS CROMADA CON ANILLAS



Código	Medida	Caja	EAN
85103	3,2 mm. Ø x 27 cm.	25	8435195815092
85104	3,2 mm. Ø x 42 cm.	25	8435195815108

Código	Medida	Caja	EAN
85105	3,8 mm. Ø x 27 cm.	25	8435195815115
85106	3,8 mm. Ø x 42 cm.	25	8435195815122

ANILLA TRIÁNGULO



	Código	Medida	Caja	EAN
Inox.	85110	Pequeña	100	8435195815139
	85112	Grande	100	8435195815153

ANILLA LLAVERO



	Código	Medida	Caja	EAN
Inox.	85117	18 x 16 x 1	100	8435195823677

ENGANCHE "U"



	Código	Descripción	Caja	EAN
Inox.	85113	3,2 mm.	100	8435195815160
	85114	3,8 mm.	100	8435195815177

ENGANCHE LLAVERO TUBULAR



	Código	Descripción	Caja	EAN
Inox.	85115	3,2 mm.	100	8435195815184
	85116	3,8 mm.	100	8435195815191

FILTROS DESAGÜE

Filtros desagüe



82



FILTROS DESAGÜE

FILTRO DESAGÜE ACERO INOXIDABLE



Código	Medida	Caja	EAN
85130	50 x 30 Lavabo / Bidé	10	8435195815078
85131	65 x 40 Fregadero / Bañera	10	8435195832594
85132	80 x 50 Fregadero / Bañera	10	8435195832600

FILTRO DESAGÜE BLANCO



Código	Medida	Caja	EAN
85135	65 x 40 Fregadero / Bañera	10	8435195832617
85136	80 x 50 Fregadero / Bañera	10	8435195832624

FILTRO DESAGÜE CAZOLETA



Código	Medida	Caja	EAN
85140	65 x 40 Fregadero / Bañera	10	8435195832631

FILTRO DESAGÜE TEKA



Código	Medida	Caja	EAN
85141	Inox. - 81 x 31 Fregadero	10	8435195832648
85142	Blanco - 81 x 31 Fregadero	10	8435195832655

FILTRO DESAGÜE TEKA CON EJE CENTRAL



Código	Medida	Caja	EAN
85143	81 x 31 Fregadero	10	8435195832662

SIFONES DESAGÜE Y ACCESORIOS

Sifones desagüe



84

Accesorios



87

SIFONES DESAGÜE

SIFÓN BOTELLA CROMADO



Código	Medida	Caja	EAN
63520	1 1/4" x 32 mm Ø	10	8435195809800

• Fabricado en latón cromado.

SIFÓN BOTELLA MINIMALISTA



Código	Medida	Caja	EAN
63515	1 1/4" x 32 mm Ø	10	8435195821598

• Fabricado en latón cromado.

TUBO ALARGO ABOCARDADO PARA SIFÓN BOTELLA



	Código	Medida	Caja	EAN
	63526	Ø 32 x 20 cm.	1	8435195823639
	63528	Ø 32 x 30 cm.	1	8435195823464
Sin pestaña	63544	Ø 32 x 20 cm.	1	8435195841589
Sin pestaña	63545	Ø 32 x 80 cm.	1	8435195826005

• Fabricado en latón cromado.

TUBO SIFÓN EXTENSIBLE BLANCO



	Código	Medida	Caja	EAN
Tuerca PVC	63510	1 1/4" x 32 mm Ø	10	8435195809718
	63511	1 1/2" x 40 mm Ø	10	8435195809725

	Código	Medida	Caja	EAN
Tuerca METAL	63512	1 1/4" x 32 mm Ø	10	8435195809732
	63513	1 1/2" x 40 mm Ø	10	8435195809749

TUBO SIFÓN EXTENSIBLE CROMADO



Código	Medida	Caja	EAN
63518	1 1/4" x 32 mm Ø	10	8435195809756
63519	1 1/2" x 40 mm Ø	10	8435195809763

TUBO ALARGO EXTENSIBLE



Código	Medida	Caja	EAN
63523	Blanco Ø 32 - 40	10	8435195809770
63524	Cromo Ø 32 - 40	10	8435195809787

SIFONES DESAGÜE

SIFÓN "Y" CON VÁLVULA LAVABO / BIDÉ



Código	Medida	Caja	EAN
25570	1 1/2" x 40 mm. Ø	50	8435195832396

- Cadena de bolas en latón cromado.
- Rejilla Ø 70 mm. de acero inox.
- Incluye junta reductora de Ø 40 mm. a Ø 32 mm.

SIFÓN BOTELLA CORTO EXTENSIBLE



Código	Medida	Caja	EAN
25571	1 1/4" x 40 mm. Ø	50	8435195832402

- Cadena de bolas en latón cromado.
- Rejilla Ø 70 mm. de acero inox.
- Incluye junta reductora de Ø 40 mm. a Ø 32 mm.

SIFÓN BOTELLA EXTENSIBLE



Código	Medida	Caja	EAN
25572	1 1/2" x 40 mm. Ø	50	8435195832419

- Cadena de bolas en latón cromado.
- Rejilla Ø 70 mm. de acero inox.
- Incluye junta reductora de Ø 40 mm. a Ø 32 mm.

SIFÓN BOTELLA EXTENSIBLE CON RACOR



Código	Medida	Caja	EAN
25574	1 1/2" x 40 mm. Ø	50	8435195832433

- Incluye junta reductora de Ø 40 mm. a Ø 32 mm.

SIFÓN CURVO EXTENSIBLE



Código	Medida	Caja	EAN
25573	1 1/2" x 40 mm. Ø	50	8435195832426

- Cadena de bolas en latón cromado.
- Rejilla Ø 70 mm. de acero inox.
- Incluye junta reductora de Ø 40 mm. a Ø 32 mm.

SIFÓN CURVO EXTENSIBLE CON RACOR



Código	Medida	Caja	EAN
25575	1 1/2" x 40 mm. Ø	50	8435195832440

- Incluye junta reductora de Ø 40 mm. a Ø 32 mm.

SIFONES DESAGÜE

SIFÓN DOBLE BOTELLA EXTENSIBLE

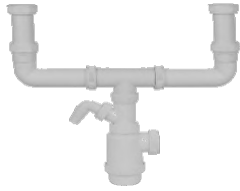

Código	Medida	Caja	EAN
25578	1 1/2" x 40 mm. Ø	14	8435195832471

- Incluye junta reductora de Ø 40 mm. a Ø 32 mm.

SIFÓN DOBLE CURVO EXTENSIBLE

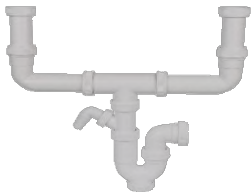

Código	Medida	Caja	EAN
25577	1 1/2" x 40 mm. Ø	10	8435195832464

- Incluye junta reductora de Ø 40 mm. a Ø 32 mm.

SIFÓN DOBLE CURVO EXTENSIBLE ORIENTABLE



Código	Medida	Caja	EAN
25576	1 1/2" x 40 mm. Ø	17	8435195832457

- Incluye junta reductora de Ø 40 mm. a Ø 32 mm.

SIFÓN DE GOMA ABIERTO PARED

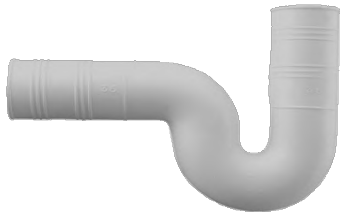

Código	Medida	Caja	EAN
85025	25 - 30 mm. Ø	30	8435195814996
85026	30 - 30 mm. Ø	30	8435195815009
85027	35 - 35 mm. Ø	30	8435195815016
85033	35 - 40 mm. Ø	10	8435195822717
85034	40 - 40 mm. Ø	10	8435195822724

SIFÓN DE GOMA CERRADO SUELO



Código	Medida	Caja	EAN
85028	25 - 30 mm. Ø	30	8435195815023
85029	30 - 30 mm. Ø	30	8435195815030
85030	35 - 35 mm. Ø	30	8435195815047
85035	40 - 40 mm. Ø	10	8435195822731

SIFÓN DE GOMA DOBLE FREGADERO

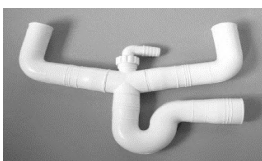

Código	Medida	Caja	EAN
85031	35 - 35 - 35 mm. Ø	10	8435195815054

- Con toma para lavavajillas.

SIFONES DESAGÜE

Accesorios

ÁLVULA DESAGÜE FREGADERO



Código	Medida	Caja	EAN
25581	1 1/2" x 85 mm. Ø	100	8435195832501

VÁLVULA COMPLETA PARA SIFÓN DE GOMA



Código	Medida	Caja	EAN
25518	30 Ø	2	8435195817799
63532	35 Ø	2	8435195823615
63533	40 Ø	2	8435195823622

VÁLVULA CON TAPÓN DE CAUCHO PARA SIFÓN BOTELLA

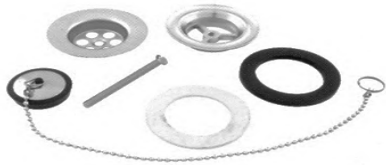

Código	Medida	Caja	EAN
63522	1 1/4"	1	8435195809824

JUNTA CAUCHO CÓNICA PARA SIFÓN



Código	Medida	Caja	EAN
25587	1 1/4" x 32 mm. Ø	100	8435195835731
25589	1 1/2" x 40 mm. Ø	100	8435195835755

CONJUNTO TUERCAS, GOMAS Y FLORÓN SIFÓN BOTELLA



Código	Medida	Caja	EAN
63527	Única	1	8435195823653

FLORÓN ABS



Código	Medida	Caja	EAN
63546	32 Ø Cromo	10	8435195826012
63547	40 Ø Cromo	10	8435195826029
63548	32 Ø Blanco	10	8435195826036
63549	40 Ø Blanco	10	8435195826043



ENCHUFES DE GOMA

Enchufes de goma



90

ACCESORIOS DE GOMA

ENCHUFE DE GOMA A PRESIÓN INODORO



Código	Medida	Caja	EAN
85021	25 mm.	50	8435195814903
85022	30 mm.	50	8435195814910

ENCHUFE DE GOMA A PRESIÓN INODORO VICTORIA



Código	Medida	Caja	EAN
85020	63 Ø Sin cuello	50	8435195814927
85024	63 Ø Con cuello	50	8435195814941

ENCHUFE DE GOMA A PRESIÓN INODORO LUCERNA

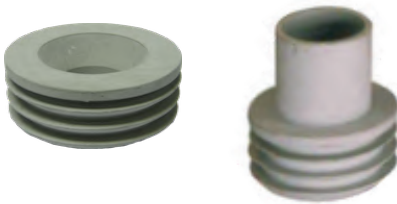

Código	Medida	Caja	EAN
85038	53 Ø Sin cuello	50	8435195833737
85023	53 Ø Con cuello	50	8435195814935

ENCHUFE DE LÁTEX A PRESIÓN INODORO



Código	Medida	Caja	EAN
99347	25 mm.	50	8435195814972
99348	30 mm.	50	8435195814989

GOMA ALIMENTADOR LUCERNA - VICTORIA





Código	Medida	Caja	EAN
98024	28 Ø	50	8435195814965

BOYA ROYAL CON VARILLA DE LATÓN



Código	Medida	Caja	EAN
85032	-	10	8435195815061

CABEZALES UNIVERSALES

Cabezales universales		92
Accesorios y repuestos		94



CABEZALES UNIVERSALES

CABEZAL UNIV. VISTO VOLANTE 3 PUNTAS METÁLICO



Código	Medida	Caja	EAN
40001	16/150	12	8435195804232
40002	17/150	12	8435195804249
40003	18/150	12	8435195804256
40004	19/150	12	8435195804263
40005	20/125	12	8435195804270
40006	20/150	12	8435195804287
40007	21/125	12	8435195804294
40008	21/150	12	8435195804300
40009	22/150	12	8435195804317
40010	23/150	12	8435195836981
40011	3/8"	12	8435195804324
40012	1/2"	12	8435195804331
40013	5/8"	12	8435195804348
40014	3/4"	12	8435195804355
40015	26/150	12	8435195821048

CABEZAL UNIV. EMPOTRAR VOLANTE 3 PUNTAS METÁLICO



Código	Medida	Caja	EAN
41001	16/150	12	8435195804362
41002	17/150	12	8435195804379
41003	18/150	12	8435195804386
41004	19/150	12	8435195804393
41005	20/125	12	8435195804409
41006	20/150	12	8435195804416
41007	21/125	12	8435195804423
41008	21/150	12	8435195804430
41009	22/150	12	8435195804447
41010	23/150	12	8435195836998
41011	3/8"	12	8435195804454
41012	1/2"	12	8435195804461
41013	5/8"	12	8435195804478
41014	3/4"	12	8435195804485
41019	26/150	12	8435195821055

CABEZALES UNIVERSALES

CABEZAL UNIVERSAL VISTO VOLANTE FACETADO METÁLICO



Código	Medida	Caja	EAN
42001	16/150	12	8435195804232
42002	17/150	12	8435195804249
42003	18/150	12	8435195804256
42004	19/150	12	8435195804263
42005	20/125	12	8435195804270
42006	20/150	12	8435195804287
42007	21/125	12	8435195804294
42008	21/150	12	8435195804300
42009	22/150	12	8435195804317
42010	23/150	12	8435195837032
42011	3/8"	12	8435195804324
42012	1/2"	12	8435195804331
42013	5/8"	12	8435195804348
42014	3/4"	12	8435195804355
42015	26/150	12	8435195821048

CABEZAL UNIV. EMPOTRAR VOLANTE FACETADO METÁLICO



Código	Medida	Caja	EAN
43001	16/150	12	8435195804362
43002	17/150	12	8435195804379
43003	18/150	12	8435195804386
43004	19/150	12	8435195804393
43005	20/125	12	8435195804409
43006	20/150	12	8435195804416
43007	21/125	12	8435195804423
43008	21/150	12	8435195804430
43009	22/150	12	8435195804447
43010	23/150	12	8435195837049
43011	3/8"	12	8435195804454
43012	1/2"	12	8435195804461
43013	5/8"	12	8435195804478
43014	3/4"	12	8435195804485
43019	26/150	12	8435195821055

CABEZALES UNIVERSALES

RECAMBIO ALARGADERAS CABEZALES



Código	Medida	Caja	EAN
86001	28 mm.	12	8435195815207
86002	32 mm.	12	8435195815214
86003	40 mm.	12	8435195815221
86005	50 mm.	12	8435195815245
86007	67 mm.	12	8435195815269
86008	97 mm.	12	8435195815276

*Hasta fin de existencias (**86005, 86007, 86008**)

PLACA MEDIDORA DE MONTURAS



Cód. **41015**

Caja: 1 ud.

EAN 8435195804225

EXPOSITOR CABEZALES



Cód. **41017**

Caja: 1 ud.

EAN 8435195822267

EJE CABEZAL / GRUPILLA / JUNTA TÓRICA

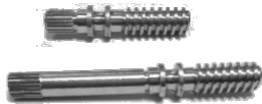

Código	Descripción	Caja	EAN
98083	Eje visto	25	8435195832679
98084	Eje empotrar	25	8435195832686



Código	Descripción	Caja	EAN
43030	Grupilla	25	8435195832693
83022	Junta tórica	25	8435195832709

MONTURA PRESIÓN CON CRUCETA



Código	Medida	Caja	EAN
19062	17 mm.	5	8435195832716
19063	18 mm.	5	8435195832723
19065	20 mm.	5	8435195834956
19067	22 mm.	5	8435195832747

VÁLVULA TRIANÓN



Código	Medida	Caja	EAN
99179	16 mm.	1	8435195832754

CABEZALES UNIVERSALES

VOLANTE OCULTO ABS



Código	Medida	Caja	EAN
19041	Única	25	8435195800876

VOLANTE OCULTO METÁLICO



Código	Medida	Caja	EAN
19031	Única	25	8435195800791

VOLANTE FACETADO



Código	Descripción	Caja	EAN
19034	Única	25	8435195800807

- Incluye tapa e índices.

VOLANTE 3 PUNTAS ABS



Código	Medida	Caja	EAN
19035	Única	25	8435195800814

VOLANTE 3 PUNTAS METÁLICO



Código	Medida	Caja	EAN
19038	Única	25	8435195800845

VOLANTE 3 PUNTAS METÁLICO CUADRADILLO



Código	Medida	Caja	EAN
19053	6,5 mm. Ø	25	8435195828221



CABEZALES UNIVERSALES

ALARGADERA CABEZAL



Código	Medida	Caja	EAN
19030	Única	25	8435195800784

TORNILLO CABEZAL



Código	Medida	Caja	EAN
98018	M - 5 x 6	25	8435195822274

ÍNDICE PARA VOLANTE ABS

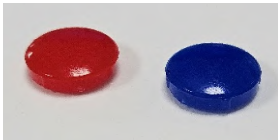

Código	Descripción	Caja	EAN
19036	Azul	25	8435195800821
19037	Rojo	25	8435195800838

ÍNDICE PARA VOLANTE METÁLICO

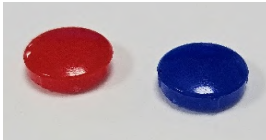

Código	Descripción	Caja	EAN
19039	Azul	25	8435195800852
19040	Rojo	25	8435195800869

CASQUILLO CUBRE MONTURAS





Código	Descripción	Caja	EAN
19042	Única	25	8435195800883

FLORÓN Y ANILLO CABEZAL



	Código	Medida	Caja	EAN
Florón	19043	Única	25	8435195800890
Anillo	29034	Única	25	8435195832761

CONEXIONES FLEXIBLES

Serie A		98
Termo "Serie Súper"		100
Batería de contador		102
Bomba de agua		103



CONEXIONES FLEXIBLES "SERIE A"

APLICACIONES:

- INSTALACIONES DE AGUA SANITARIA
- LAVABOS
- BIDETS
- CONEXIONES DE GRIFERÍA

CARACTERÍSTICAS TÉCNICAS:

- RACORES: LATÓN
- ROSCAS: BSP 3/8" - 1/2"
- CAMPANA: ACERO INOXIDABLE
- TUBO: TUBO DE CAUCHO E.P.D.M. ATÓXICO
- MALLA: TRENZADO 7 HILOS EN ACERO INOX. AISI 304
- NORMA: UNE 53.626



Ø INT.TUBO mm.	Ø EXT.TUBO mm.	TEMPERATURA MÁXIMA	TEMPERATURA CONTÍNUA	PRESIÓN TRABAJO	PRESIÓN ROTURA	RADIO CURVATURA	CAUDAL NOMINAL
9 mm.	13 mm.	100°C	70°C	25 Kg/cm ²	100 Kg/cm ²	40 mm.	29l./min.

M 1/2" - H 3/8"

Código	Medida	Caja	EAN
55021	M 1/2" - H 3/8" x 15	10	8435195807226
55022	M 1/2" - H 3/8" x 20	10	8435195807233
55023	M 1/2" - H 3/8" x 25	10	8435195807240
55024	M 1/2" - H 3/8" x 30	10	8435195807257
55025	M 1/2" - H 3/8" x 35	10	8435195807264
55026	M 1/2" - H 3/8" x 40	10	8435195807271
55027	M 1/2" - H 3/8" x 45	10	8435195807288
55028	M 1/2" - H 3/8" x 50	10	8435195807295
55029	M 1/2" - H 3/8" x 60	10	8435195826135
55030	M 1/2" - H 3/8" x 100	10	8435195826142

M 3/8" - H 1/2"

Código	Medida	Caja	EAN
55521	M 3/8" - H 1/2" x 15	10	8435195807301
55522	M 3/8" - H 1/2" x 20	10	8435195807318
55523	M 3/8" - H 1/2" x 25	10	8435195807325
55524	M 3/8" - H 1/2" x 30	10	8435195807332
55525	M 3/8" - H 1/2" x 35	10	8435195807349
55526	M 3/8" - H 1/2" x 40	10	8435195807356
55527	M 3/8" - H 1/2" x 45	10	8435195807363
55528	M 3/8" - H 1/2" x 50	10	8435195807370
55529	M 3/8" - H 1/2" x 60	10	8435195826159
55530	M 3/8" - H 1/2" x 100	10	8435195826166

M 3/8" - H 3/8"

Código	Medida	Caja	EAN
56021	M 3/8" - H 3/8" x 15	10	8435195806823
56022	M 3/8" - H 3/8" x 20	10	8435195806830
56023	M 3/8" - H 3/8" x 25	10	8435195806847
56024	M 3/8" - H 3/8" x 30	10	8435195806854
56025	M 3/8" - H 3/8" x 35	10	8435195806861
56026	M 3/8" - H 3/8" x 40	10	8435195806878
56027	M 3/8" - H 3/8" x 45	10	8435195806885
56028	M 3/8" - H 3/8" x 50	10	8435195806892
56029	M 3/8" - H 3/8" x 60	10	8435195826173
56031	M 3/8" - H 3/8" x 70	10	8435195839838
56030	M 3/8" - H 3/8" x 100	10	8435195826180

CONEXIONES FLEXIBLES "SERIE A"

H 1/2" - H 1/2"

Código	Medida	Caja	EAN
52521	H 1/2" - H 1/2" x 15	10	8435195806984
52522	H 1/2" - H 1/2" x 20	10	8435195806991
52523	H 1/2" - H 1/2" x 25	10	8435195807004
52524	H 1/2" - H 1/2" x 30	10	8435195807011
52525	H 1/2" - H 1/2" x 35	10	8435195807028
52526	H 1/2" - H 1/2" x 40	10	8435195807035
52527	H 1/2" - H 1/2" x 45	10	8435195807042
52528	H 1/2" - H 1/2" x 50	10	8435195807059
52529	H 1/2" - H 1/2" x 60	10	8435195826050
52530	H 1/2" - H 1/2" x 100	10	8435195826067
52533	H 1/2" - H 1/2" x 150	10	8435195839630
52532	H 1/2" - H 1/2" x 200	10	8435195839623

H 3/8" - H 3/8"

Código	Medida	Caja	EAN
53020	H 3/8" - H 3/8" x 10	10	8435195839708
53021	H 3/8" - H 3/8" x 15	10	8435195806908
53022	H 3/8" - H 3/8" x 20	10	8435195806915
53023	H 3/8" - H 3/8" x 25	10	8435195806922
53024	H 3/8" - H 3/8" x 30	10	8435195806939
53025	H 3/8" - H 3/8" x 35	10	8435195806946
53026	H 3/8" - H 3/8" x 40	10	8435195806953
53028	H 3/8" - H 3/8" x 50	10	8435195806977
53029	H 3/8" - H 3/8" x 60	10	8435195826074
53031	H 3/8" - H 3/8" x 70	10	8435195839715
53030	H 3/8" - H 3/8" x 100	10	8435195826081
53011	H 3/8" - H 3/8" x 150	10	8435195839692
53010	H 3/8" - H 3/8" x 200	10	8435195839685

H 1/2" - H 3/8"

Código	Medida	Caja	EAN
53521	H 1/2" - H 3/8" x 15	10	8435195807066
53522	H 1/2" - H 3/8" x 20	10	8435195807073
53523	H 1/2" - H 3/8" x 25	10	8435195807080
53524	H 1/2" - H 3/8" x 30	10	8435195807097
53525	H 1/2" - H 3/8" x 35	10	8435195807103
53526	H 1/2" - H 3/8" x 40	10	8435195807110
53527	H 1/2" - H 3/8" x 45	10	8435195807127
53528	H 1/2" - H 3/8" x 50	10	8435195807134
53529	H 1/2" - H 3/8" x 60	10	8435195826098
53530	H 1/2" - H 3/8" x 100	10	8435195826104

M 1/2" - H 1/2"

Código	Medida	Caja	EAN
54021	M 1/2" - H 1/2" x 15	10	8435195807141
54022	M 1/2" - H 1/2" x 20	10	8435195807158
54023	M 1/2" - H 1/2" x 25	10	8435195807165
54024	M 1/2" - H 1/2" x 30	10	8435195807172
54025	M 1/2" - H 1/2" x 35	10	8435195807189
54026	M 1/2" - H 1/2" x 40	10	8435195807196
54027	M 1/2" - H 1/2" x 45	10	8435195807102
54028	M 1/2" - H 1/2" x 50	10	8435195807119
54029	M 1/2" - H 1/2" x 60	10	8435195826111
54031	M 1/2" - H 1/2" x 70	10	8435195839814
54030	M 1/2" - H 1/2" x 100	10	8435195826128
54009	M 1/2" - H 1/2" x 150	10	8435195839753
54008	M 1/2" - H 1/2" x 200	10	8435195839746

Nota: Se pueden fabricar conexiones sobre pedido, en cualquier medida y largo.



CONEXIONES FLEXIBLES TERMO "SERIE SÚPER"

APLICACIONES:

- INSTALACIONES DE AGUA SANITARIA
- CALENTADORES
- TERMOS
- ACUMULADORES
- PLACAS SOLARES
- AIRE ACONDICIONADO



CARACTERÍSTICAS TÉCNICAS:

- RACORES: LATÓN
- ROSCAS: BSP 1/2" - 3/4"
- CAMPANA: ACERO INOXIDABLE
- TUBO: TUBO DE CAUCHO E.P.D.M. ATÓXICO
- MALLA: TRENZADO 7 HILOS EN ACERO INOX. AISI 304

Ø INT.TUBO mm.	Ø EXT.TUBO mm.	TEMPERATURA MÁXIMA	TEMPERATURA CONTÍNUA	PRESIÓN TRABAJO	PRESIÓN ROTURA	RADIO CURVATURA	CAUDAL NOMINAL
13 mm.	19 mm.	100°C	70°C	20 Kg/cm ²	80 Kg/cm ²	50 mm.	75l./min.

M 1/2" - H 1/2"

Código	Medida	Caja	EAN
56511	M 1/2" - H 1/2" x 15	10	8435195807387
56512	M 1/2" - H 1/2" x 20	10	8435195807394
56513	M 1/2" - H 1/2" x 25	10	8435195807400
56514	M 1/2" - H 1/2" x 30	10	8435195807417
56515	M 1/2" - H 1/2" x 35	10	8435195807424
56516	M 1/2" - H 1/2" x 40	10	8435195807431
56517	M 1/2" - H 1/2" x 45	10	8435195807448
56518	M 1/2" - H 1/2" x 50	10	8435195807455
56519	M 1/2" - H 1/2" x 60	10	8435195826197
56510	M 1/2" - H 1/2" x 80	10	8435195840346
56520	M 1/2" - H 1/2" x 100	10	8435195826203

H 1/2" - H 1/2"

Código	Medida	Caja	EAN
56521	H 1/2" - H 1/2" x 15	10	8435195807462
56522	H 1/2" - H 1/2" x 20	10	8435195807479
56523	H 1/2" - H 1/2" x 25	10	8435195807486
56524	H 1/2" - H 1/2" x 30	10	8435195807493
56525	H 1/2" - H 1/2" x 35	10	8435195807509
56526	H 1/2" - H 1/2" x 40	10	8435195807516
56527	H 1/2" - H 1/2" x 45	10	8435195807523
56528	H 1/2" - H 1/2" x 50	10	8435195807530
56529	H 1/2" - H 1/2" x 60	10	8435195826210
56530	H 1/2" - H 1/2" x 100	10	8435195826227

M 1/2" - H 3/4"

Código	Medida	Caja	EAN
56531	M 1/2" - H 3/4" x 15	10	8435195807547
56532	M 1/2" - H 3/4" x 20	10	8435195807554
56533	M 1/2" - H 3/4" x 25	10	8435195807561
56534	M 1/2" - H 3/4" x 30	10	8435195807578
56535	M 1/2" - H 3/4" x 35	10	8435195807585
56536	M 1/2" - H 3/4" x 40	10	8435195807592
56537	M 1/2" - H 3/4" x 45	10	8435195807608
56538	M 1/2" - H 3/4" x 50	10	8435195807615
56539	M 1/2" - H 3/4" x 60	10	8435195826234
56540	M 1/2" - H 3/4" x 100	10	8435195826241

CONEXIONES FLEXIBLES TERMO "SERIE SÚPER"

H 1/2" - H 3/4"

Código	Medida	Caja	EAN
56541	M 1/2" - H 3/4" x 15	10	8435195807622
56542	M 1/2" - H 3/4" x 20	10	8435195807639
56543	M 1/2" - H 3/4" x 25	10	8435195807646
56544	M 1/2" - H 3/4" x 30	10	8435195807653
56545	M 1/2" - H 3/4" x 35	10	8435195807660
56546	M 1/2" - H 3/4" x 40	10	8435195807677
56547	M 1/2" - H 3/4" x 45	10	8435195807684
56548	M 1/2" - H 3/4" x 50	10	8435195807691
56549	M 1/2" - H 3/4" x 60	10	8435195826258
56550	M 1/2" - H 3/4" x 100	10	8435195826265

M 3/4" - H 3/4"

Código	Medida	Caja	EAN
56551	M 3/4" - H 3/4" x 15	10	8435195807707
56552	M 3/4" - H 3/4" x 20	10	8435195807714
56553	M 3/4" - H 3/4" x 25	10	8435195807721
56554	M 3/4" - H 3/4" x 30	10	8435195807738
56555	M 3/4" - H 3/4" x 35	10	8435195807745
56556	M 3/4" - H 3/4" x 40	10	8435195807752
56557	M 3/4" - H 3/4" x 45	10	8435195807769
56558	M 3/4" - H 3/4" x 50	10	8435195807776
56559	M 3/4" - H 3/4" x 60	10	8435195826272
56560	M 3/4" - H 3/4" x 100	10	8435195826289

M 3/4" - H 1/2"

Código	Medida	Caja	EAN
56561	M 3/4" - H 1/2" x 15	10	8435195807783
56562	M 3/4" - H 1/2" x 20	10	8435195807790
56563	M 3/4" - H 1/2" x 25	10	8435195807806
56564	M 3/4" - H 1/2" x 30	10	8435195807813
56565	M 3/4" - H 1/2" x 35	10	8435195807820
56566	M 3/4" - H 1/2" x 40	10	8435195807837
56567	M 3/4" - H 1/2" x 45	10	8435195807844
56568	M 3/4" - H 1/2" x 50	10	8435195807851
56569	M 3/4" - H 1/2" x 60	10	8435195826296
56570	M 3/4" - H 1/2" x 100	10	8435195826302

H 3/4" - H 3/4"

Código	Medida	Caja	EAN
56571	H 3/4" - H 3/4" x 15	10	8435195807868
56572	H 3/4" - H 3/4" x 20	10	8435195807875
56573	H 3/4" - H 3/4" x 25	10	8435195807882
56574	H 3/4" - H 3/4" x 30	10	8435195807899
56575	H 3/4" - H 3/4" x 35	10	8435195807905
56576	H 3/4" - H 3/4" x 40	10	8435195807912
56577	H 3/4" - H 3/4" x 45	10	8435195807929
56578	H 3/4" - H 3/4" x 50	10	8435195807936
56579	H 3/4" - H 3/4" x 60	10	8435195826319
56580	H 3/4" - H 3/4" x 100	10	8435195826326

Nota: Se pueden fabricar conexiones sobre pedido, en cualquier medida y largo.



CONEXIONES FLEXIBLES BATERÍAS CONTADOR

APLICACIONES:

- BATERÍAS DE CONTADOR
- ACOMETIDAS
- CALEFACCIÓN
- AIRE ACONDICIONADO



CARACTERÍSTICAS TÉCNICAS:

- RACORES: LATÓN
- ROSCAS: BSP 3/4" - 1" - 1 1/4"
- CAMPANA: ACERO INOXIDABLE
- TUBO: TUBO DE CAUCHO E.P.D.M. ATÓXICO
- MALLA: TRENZADO EN ACERO INOX. AISI 304

CONEXIÓN	Ø INT.TUBO mm.	Ø EXT.TUBO mm.	TEMPERATURA MÁXIMA	TEMPERATURA CONTÍNUA	PRESIÓN TRABAJO	PRESIÓN ROTURA	RADIO CURVATURA	CAUDAL NOMINAL
3/4"	19 mm.	28 mm.	90°C	70°C	15 Kg/cm ²	60 Kg/cm ²	80 mm.	150 l./min.
1"	25 mm.	35 mm.	90°C	70°C	10 Kg/cm ²	40 Kg/cm ²	130 mm.	250 l./min.
1 1/4"	30 mm.	40 mm.	90°C	70°C	10 Kg/cm ²	40 Kg/cm ²	200 mm.	400l./min.

M 3/4" - H 3/4"

Código	Medida	Caja	EAN
56102	M 3/4" - H 3/4" x 30	1	8435195823431
56104	M 3/4" - H 3/4" x 40	1	8435195823448
56106	M 3/4" - H 3/4" x 50	1	8435195823455
56108	M 3/4" - H 3/4" x 60	1	8435195823462
56110	M 3/4" - H 3/4" x 80	1	8435195823479
56112	M 3/4" - H 3/4" x 100	1	8435195823486

M 1" - H 1"

Código	Medida	Caja	EAN
56117	M 1" - H 1" x 30	1	8435195823493
56119	M 1" - H 1" x 40	1	8435195823509
56121	M 1" - H 1" x 50	1	8435195823516
56123	M 1" - H 1" x 60	1	8435195823523
56125	M 1" - H 1" x 80	1	8435195823530
56127	M 1" - H 1" x 100	1	8435195823547

M 1 1/4" - H 1 1/4"

Código	Medida	Caja	EAN
56131	M 1 1/4" - H 1 1/4" x 30	1	8435195823554
56133	M 1 1/4" - H 1 1/4" x 40	1	8435195823561
56135	M 1 1/4" - H 1 1/4" x 50	1	8435195823578
56137	M 1 1/4" - H 1 1/4" x 60	1	8435195823585
56139	M 1 1/4" - H 1 1/4" x 80	1	8435195823592
56141	M 1 1/4" - H 1 1/4" x 100	1	8435195823608

Nota: Se pueden fabricar conexiones sobre pedido, en cualquier medida y largo.

CONEXIONES FLEXIBLES PARA BOMBA DE AGUA

APLICACIONES:

- BOMBAS DE AGUA
- ACOMETIDAS INSTALACIONES INDUSTRIALES



CARACTERÍSTICAS TÉCNICAS:

- RACORES: LATÓN
- ROSCAS: BSP 3/4" - 1" - 1 1/4" - 1 1/2" - 2"
- CAMPANA: ACERO GALVANIZADO
- TUBO: TUBO DE CAUCHO E.P.D.M. ATÓXICO
- MALLA: TRENZADO EN ACERO GALVANIZADO

Apartir de 1" los tubos incorporan un refuerzo de trenzado intermedio.

CONEXIÓN	Ø INT.TUBO mm.	Ø EXT.TUBO mm.	TEMPERATURA MÁXIMA	TEMPERATURA CONTÍNUA	PRESIÓN TRABAJO	PRESIÓN ROTURA	RADIO CURVATURA	CAUDAL NOMINAL
3/4"	19 mm.	28 mm.	90°C	70°C	15 Kg/cm ²	60 Kg/cm ²	80 mm.	150 l./min.
1"	25 mm.	35 mm.	90°C	70°C	12 Kg/cm ²	40 Kg/cm ²	130 mm.	250 l./min.
1 1/4"	30 mm.	40 mm.	90°C	70°C	10 Kg/cm ²	30 Kg/cm ²	200 mm.	400 l./min.
1 1/2"	40 mm.	52 mm.	90°C	70°C	8 Kg/cm ²	25 Kg/cm ²	230 mm.	750 l./min.
2"	50 mm.	62 mm.	90°C	70°C	7 Kg/cm ²	20 Kg/cm ²	300 mm.	1250 l./min.

M 3/4" - H 3/4"

Código	Medida	Caja	EAN
50104	M 3/4" - H 3/4" x 40	1	8435195826333
50106	M 3/4" - H 3/4" x 50	1	8435195826340
50108	M 3/4" - H 3/4" x 60	1	8435195826357

H 3/4" - H 3/4"

Código	Medida	Caja	EAN
50116	H 3/4" - H 3/4" x 40	1	8435195826364
50118	H 3/4" - H 3/4" x 50	1	8435195826371
50120	H 3/4" - H 3/4" x 60	1	8435195826388

M 1" - H 1"

Código	Medida	Caja	EAN
50126	M 1" - H 1" x 40	1	8435195826395
50128	M 1" - H 1" x 50	1	8435195826401
50130	M 1" - H 1" x 60	1	8435195826418

H 1" - H 1"

Código	Medida	Caja	EAN
50137	H 1" - H 1" x 40	1	8435195826425
50139	H 1" - H 1" x 50	1	8435195826432
50140	H 1" - H 1" x 60	1	8435195826449

M 1 1/4" - H 1 1/4"

Código	Medida	Caja	EAN
50148	M 1 1/4" - H 1 1/4" x 40	1	8435195826456
50150	M 1 1/4" - H 1 1/4" x 50	1	8435195826463
50151	M 1 1/4" - H 1 1/4" x 60	1	8435195826470



CONEXIONES FLEXIBLES PARA BOMBA DE AGUA

H 1 1/4" - H 1 1/4"

Código	Medida	Caja	EAN
50163	H 1 1/4" - H 1 1/4" x 40	1	8435195826487
50165	H 1 1/4" - H 1 1/4" x 50	1	8435195826494
50167	H 1 1/4" - H 1 1/4" x 60	1	8435195826500

M 1 1/2" - H 1 1/2"

Código	Medida	Caja	EAN
50174	M 1 1/2" - H 1 1/2" x 40	1	8435195826517
50176	M 1 1/2" - H 1 1/2" x 50	1	8435195826524
50178	M 1 1/2" - H 1 1/2" x 60	1	8435195826531

H 1 1/2" - H 1 1/2"

Código	Medida	Caja	EAN
50188	H 1 1/2" - H 1 1/2" x 40	1	8435195826548
50190	H 1 1/2" - H 1 1/2" x 50	1	8435195826555
50192	H 1 1/2" - H 1 1/2" x 60	1	8435195826562

M 2" - H 2"

Código	Medida	Caja	EAN
50203	M 2" - H 2" x 40	1	8435195826579
50205	M 2" - H 2" x 50	1	8435195826586
50207	M 2" - H 2" x 60	1	8435195826593

H 2" - H 2"

Código	Medida	Caja	EAN
50218	H 2" - H 2" x 40	1	8435195826609
50220	H 2" - H 2" x 50	1	8435195826616
50222	H 2" - H 2" x 60	1	8435195826623

Nota: Se pueden fabricar conexiones sobre pedido, en cualquier medida y largo.

CONEXIONES PARA LAVADORA

Conexiones lavadora / lavavajillas



104

CONEXIONES PARA LAVADORA

TOMA ENTRADA LAVADORA / LAVAVAJILLAS



Código	Medida	Caja	EAN
52006	1,5 m.	10	8435195806663
52007	2 m.	10	8435195806670
52014	3 m.	10	8435195806687

• Tuerca nylon.

TOMA ENTRADA LAVADORA / LAVAVAJILLAS



Código	Medida	Caja	EAN
52008	1,5 m.	10	8435195806694
52009	2 m.	10	8435195806700
52013	3 m.	10	8435195806717

• Tuerca latón.

SALIDA DE LAVADORA / LAVAVAJILLAS



Código	Medida	Caja	EAN
52010	1,5 m.	10	8435195806724
52012	2 m.	10	8435195806748
52015	3 m.	10	8435195806755

SALIDA DE LAVADORA / LAVAVAJILLAS EXTENSIBLE



Código	Medida	Caja	EAN
52017	0,60 a 1,60 m.	10	8435195821307

CURVA SALIDA LAVADORA / LAVAVAJILLAS



Código	Medida	Caja	EAN
52011	única	10	8435195806731

VÁLVULAS ESFERA EMPOTRAR

Válvulas esfera empotrar



108

Accesorios



109

VÁLVULAS ESFERA EMPOTRAR

VÁLVULA ESFERA SERIE BOSTON SOLDAR



Código	Medida	Caja	EAN
27015	15 x 15	10	8435195802573
27018	18 x 18	10	8435195802580
27022	22 x 22	10	8435195802597
27028	28 x 28	10	8435195802603

- Válvula de esfera empotrar SOLDAR.
- PN 16 Paso total.
- Fabricada en latón UNE-EN 12165.
- Extremos para soldar H-H.
- ISO 228/1. Temperatura máxima 150°C.

VÁLVULA ESFERA SERIE BOSTON ROSCAR



Código	Medida	Caja	EAN
27503	1/2" X 1/2"	10	8435195802610
27504	3/4" X 3/4"	10	8435195802627
27505	1" X 1"	10	8435195802634

- Válvula de esfera empotrar ROSCAR.
- PN 16 Paso total.
- Fabricada en latón UNE-EN 12165.
- Extremos roscados H-H.
- ISO 228/1. Temperatura máxima 150°C.

VÁLVULA ESFERA SERIE BOSTON MULTICAPA



Código	Medida	Caja	EAN
27616	Ø 16	10	8435195820157
27620	Ø 20	10	8435195820164
27625	Ø 25	10	8435195820171
27632	Ø 32	10	8435195820188

- Válvula empotrar tubería PEX y MULTICAPA con casquillos.
- PN 25 Paso total.
- Fabricada en latón cromado según UNE-EN 12165.
- Juntas E. P. D. M.
- Temperatura máxima 110°C.

VÁLVULAS ESFERA EMPOTRAR

Accesorios

MANDO Y FLORÓN METÁLICO "MODELO MERCURI"

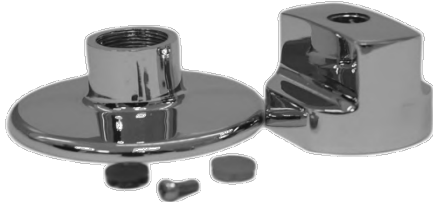

Código	Medida	Caja	EAN
28001	Única	50	8435195802658

MANDO Y FLORÓN PALANCA METÁLICO "ONDA"



Código	Medida	Caja	EAN
29003	Única	50	8435195802665

MANDO Y FLORÓN OCULTO METÁLICO "POLARE"



Código	Medida	Caja	EAN
29504	Única	50	8435195802672
29506	Con cuadradillo	50	8435195826647

- Compatible con válvulas empotrar Uponor y multicapa.

ALARGADERA VÁLVULA EMPOTRAR SERIE BOSTON





Código	Medida	Caja	EAN
19032	Única	25	8435195802689

- Incluye el tornillo.



VÁLVULAS DE CONTROL

Soldar		112
Roscar		113
Recambios		114

VÁLVULAS DE CONTROL SOLDAR

VÁLVULA CONTROL SOLDAR VOL. 3 PUNTAS ABS



	Código	Medida	Caja	EAN
Cuello largo	15015	15 x 15	72	8435195800180
	15018	18 x 18	72	8435195800197
	15022	22 x 22	72	8435195800203
	15028	28 x 28	36	8435195800210

	Código	Medida	Caja	EAN
Cuello corto	15122	22 x 22	72	8435195800241

VÁLVULA CONTROL SOLDAR VOL. 3 PUNTAS METÁLICO



	Código	Medida	Caja	EAN
Cuello largo	15515	15 x 15	72	8435195800258
	15518	18 x 18	72	8435195800265
	15522	22 x 22	72	8435195800272
	15528	28 x 28	36	8435195800289

	Código	Medida	Caja	Código Barras
Cuello corto	15622	22 x 22	72	8435195800319

VÁLVULA CONTROL SOLDAR VOL. FACETADO METÁLICO



	Código	Medida	Caja	EAN
Cuello largo	16015	15 x 15	72	8435195800326
	16018	18 x 18	72	8435195800333
	16022	22 x 22	72	8435195800340
	16028	28 x 28	36	8435195800357

	Código	Medida	Caja	EAN
Cuello corto	16122	22 x 22	72	8435195800388

VÁLVULA CONTROL SOLDAR VOL. OCULTO ABS



	Código	Medida	Caja	EAN
Cuello largo	16515	15 x 15	72	8435195800395
	16518	18 x 18	72	8435195800401
	16522	22 x 22	72	8435195800418
	16528	28 x 28	36	8435195800425

	Código	Medida	Caja	EAN
Cuello corto	16622	22 x 22	72	8435195800456

VÁLVULA CONTROL SOLDAR VOL. OCULTO METÁLICO



	Código	Medida	Caja	EAN
Cuello largo	16715	15 x 15	72	8435195800463
	16718	18 x 18	72	8435195800470
	16722	22 x 22	72	8435195800487
	16728	28 x 28	36	8435195800494

	Código	Medida	Caja	EAN
Cuello corto	16822	22 x 22	72	8435195800524

VÁLVULAS DE CONTROL ROSCAR

VÁLVULA CONTROL ROSCAR VOLANTE 3 PUNTAS ABS



Código	Medida	Caja	EAN
17002	H 1/2" x H 1/2"	36	8435195800531
17004	H 3/4" x H 3/4"	36	8435195800548

VÁLVULA CONTROL ROSCAR VOLANTE 3 PUNTAS METÁLICO



Código	Medida	Caja	EAN
17502	H 1/2" x H 1/2"	36	8435195800555
17504	H 3/4" x H 3/4"	36	8435195800562

VÁLVULA CONTROL ROSCAR VOLANTE FACETADO METÁLICO



Código	Medida	Caja	EAN
18002	H 1/2" x H 1/2"	36	8435195800579
18004	H 3/4" x H 3/4"	36	8435195800586

VÁLVULA CONTROL ROSCAR VOLANTE OCULTO



Código	Medida	Caja	EAN
18502	H 1/2" x H 1/2"	36	8435195800593
18504	H 3/4" x H 3/4"	36	8435195800609

VÁLVULA DUCHA PISCINAS VOLANTE FACETADO METÁLICO



	Código	Medida	Caja	EAN
Cuello corto	18507	H 1/2" x H 1/2"	36	8435195800623

VÁLVULA DUCHA PISCINAS VOLANTE OCULTO METÁLICO



	Código	Medida	Caja	EAN
Cuello largo	18508	H 1/2" x H 1/2"	36	8435195800630

	Código	Medida	Caja	EAN
Cuello corto	18511	H 1/2" x H 1/2"	36	8435195800647



RECAMBIOS VÁLVULAS CONTROL

CUERPO VÁLVULA CONTROL



	Código	Medida	Caja	EAN
Cuello largo	18615	15 x 15 Ø soldar	10	8435195800654
	18618	18 x 18 Ø soldar	10	8435195800661
	18622	22 x 22 Ø soldar	10	8435195800678
	18628	28 x 28 Ø soldar	10	8435195800685
	18629	H 1/2" x H 1/2" roscar	10	8435195800692
	18630	H 3/4" x H 3/4" roscar	10	8435195800708

	Código	Medida	Caja	EAN
Cuello corto	19022	22 x 22 Ø soldar	10	8435195800739
	18631	H 1/2" x H 1/2" roscar	10	8435195834758

MONTURA VÁLVULA CONTROL



	Código	Medida	Caja	EAN
Empotrar	19023	19/150	36	8435195800746
	19024	22/150	36	8435195800753
	19028	1/2"	36	8435195834819



	Código	Medida	Caja	EAN
Oculto	19025	19/150	36	8435195800760
	19026	22/150	36	8435195800777
	19017	1/2"	36	

VOLANTE OCULTO ABS



Código	Medida	Caja	EAN
19041	Única	25	8435195800876

VOLANTE OCULTO METÁLICO



Código	Medida	Caja	EAN
19031	Única	25	8435195800791

VOLANTE FACETADO

Cód. **19034**
Caja: 25 uds.
EAN 8435195800807



VOLANTE 3 PUNTAS ABS

Cód. **19035**
Caja: 25 uds.
EAN 8435195800814



VOLANTE 3 PUNTAS METÁLICO

Cód. **19038**
Caja: 25 uds.
EAN 8435195800845



VOLANTE 3 P METAL. CUADRADILLO

Cód. **19053**
Caja: 25 uds.
EAN 8435195828221



CABEZALES UNIVERSALES

ALARGADERA CABEZAL



Código	Medida	Caja	EAN
19030	Única	25	8435195800784

TORNILLO CABEZAL



Código	Medida	Caja	EAN
98018	M - 5 x 6	25	8435195822274

ÍNDICE PARA VOLANTE ABS



Código	Descripción	Caja	EAN
19036	Azul	25	8435195800821
19037	Rojo	25	8435195800838

ÍNDICE PARA VOLANTE METÁLICO



Código	Descripción	Caja	EAN
19039	Azul	25	8435195800852
19040	Rojo	25	8435195800869

CASQUILLO CUBRE MONTURAS



Código	Descripción	Caja	EAN
19042	Única	25	8435195800883

FLORÓN Y ANILLO CABEZAL



	Código	Medida	Caja	EAN
Florón	19043	Única	25	8435195800890
Anillo	29034	Única	25	8435195832761



VÁLVULAS DE ESFERA

Válvulas esfera palanca		118
Válvulas esfera cuadradillo		119
Válvulas esfera palomilla		120
Válvulas esfera mini		121



VÁLVULAS DE ESFERA

Mando palanca

CARACTERÍSTICAS TÉCNICAS:

- PN30. Rosca Gas, ISO 228/1.
- Temperatura máxima 120°C.
- Prensa estopa con guarnición de PTFE.
- Maneta de acero con PVC.

VÁLVULA ESFERA H-H PALANCA ACERO



Código	Medida	Caja	EAN
20011	1/4"	100	8435195800975
20012	3/8"	100	8435195800982
20013	1/2"	100	8435195800999
20014	3/4"	100	8435195801002
20015	1"	50	8435195801019
20016	1 1/4"	28	8435195801026
20017	1 1/2"	16	8435195801033
20018	2"	8	8435195801040
20019	2 1/2"	4	8435195801057
20020	3"	2	8435195801064
20021	4"	2	8435195801071

VÁLVULA ESFERA M-H PALANCA ACERO



Código	Medida	Caja	EAN
22005	3/8"	100	8435195801125
22006	1/2"	100	8435195801132
22007	3/4"	50	8435195801149
22008	1"	50	8435195801156

VÁLVULA ESFERA M-M PALANCA ACERO

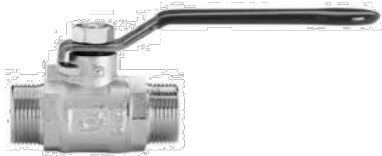

Código	Medida	Caja	EAN
22524	3/8"	10	8435195826654
22508	1/2"	10	8435195822199
22509	3/4"	10	8435195822205
22510	1"	10	8435195822212

VÁLVULA ESFERA SOLDAR PALANCA ACERO



Código	Medida	Caja	EAN
22115	15 x 15 Ø	100	8435195801163
22118	18 x 18 Ø	100	8435195801170
22122	22 x 22 Ø	60	8435195801170
22128	28 x 28 Ø	50	8435195801187
22135	35 x 35 Ø	10	8435195801194
22142	42 x 42 Ø	10	8435195820096
22154	54 x 54 Ø	10	8435195820102

VÁLVULA ESF. POLIPROPILENO H-H PAL. ALUMINIO



Código	Medida	Caja	EAN
20003	1/2"	20	8435195800913
20004	3/4"	20	8435195800920
20005	1"	10	8435195800937
20006	1 1/4"	5	8435195800944
20007	1 1/2"	5	8435195800951
20008	2"	2	8435195800968

VÁLVULAS DE ESFERA

Mando cuadradillo

CARACTERÍSTICAS TÉCNICAS:

- PN30. Rosca Gas, ISO 228/1.
- Temperatura máxima 120°C.
- Prensa estopa con guarnición de PTFE.

VÁLVULA ESFERA H-H CUADRADILLO "MALLORCA"



Código	Medida	Caja	EAN
22603	1/2" - 14	20	8435195801309
22604	3/4" - 14	20	8435195801309
22605	1" - 16	20	8435195801309
22606	1 1/4" - 16	20	8435195801309
22607	1 1/2" - 18	20	8435195801309
22608	2" - 18	20	8435195801309

VÁLVULA ESFERA M-H CUADRADILLO "MALLORCA"



Código	Medida	Caja	EAN
22612	1/2" - 14	10	8435195801361
22613	3/4" - 14	10	8435195801378
22614	1" - 16	5	8535195801385

VÁLVULA ESFERA ESCUADRA CUADRADILLO



	Código	Medida	Caja	EAN
M - H	22601	1/2" - 14	10	8435195801286

	Código	Medida	Caja	EAN
M - M	22602	1/2" - 14	10	8435195801293

VÁLVULA ESFERA H-H CUADRADILLO



Código	Medida	Caja	EAN
22621	1/2" - 18	20	8435195801392
22622	3/4" - 18	20	8435195801408
22623	1" - 18	10	8435195801415
22624	1 1/4" - 25	5	8435195801422
22625	1 1/2" - 25	5	8435195801439
22626	2" - 25	5	8435195801446
22627	2 1/2" - 26	2	8435195820126
22628	3" - 26	2	8435195820133
22629	4" - 36	2	8435195820140

VÁLVULA ESFERA M-H CUADRADILLO



Código	Medida	Caja	EAN
22630	1/2" - 18	20	8435195801453
22631	3/4" - 18	20	8435195801460
22632	1" - 18	10	8435195801477



VÁLVULAS DE ESFERA

Mando palomilla

CARACTERÍSTICAS TÉCNICAS:

- PN30. Rosca Gas, ISO 228/1.
- Temperatura máxima 120°C.
- Prensa estopa con guarnición de PTFE.
- Maneta palomilla de aluminio.

VÁLVULA ESFERA H-H PALOMILLA



Código	Medida	Caja	EAN
20501	1/4"	100	8435195826661
20502	3/8"	100	8435195801088
20503	1/2"	100	8435195801095
20504	3/4"	50	8435195801101
20505	1"	50	8435195801118

VÁLVULA ESFERA M-H PALOMILLA



Código	Medida	Caja	EAN
22501	1/4"	100	8435195826678
22502	3/8"	100	8435195826685
22503	1/2"	100	8435195801200
22504	3/4"	60	8435195801217
22505	1"	50	8435195801224

VÁLVULA ESFERA M-M PALOMILLA

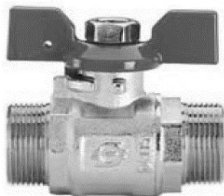

Código	Medida	Caja	EAN
22511	1/2"	10	8435195822229
22512	3/4"	10	8435195822236
22517	1"	10	8435195822243

VÁLVULA ESFERA ESCUADRA PALOMILLA



	Código	Medida	Caja	EAN
M - H	22506	1/2" x 1/2"	10	8435195801231

	Código	Medida	Caja	EAN
M - M	22507	1/2" x 1/2"	10	8435195801248

- Maneta palomilla de aluminio amarilla.

VÁLVULA ESFERA SOLDAR PALOMILLA



Código	Medida	Caja	EAN
22515	15 x 15 Ø	100	8435195801255
22518	18 x 18 Ø	100	8435195801262
22522	22 x 22 Ø	60	8435195801279

VÁLVULAS DE ESFERA

CARACTERÍSTICAS TÉCNICAS:

• PN16. Rosca Gas, ISO 228/1.

• Temperatura máxima 100°C.

VÁLVULA ESFERA MINI H-H



Código	Medida	Caja	EAN
23001	1/4"	20	8435195826692
23002	3/8"	20	8435195801484
23003	1/2"	20	8435195801491
23004	3/4"	20	8435195801507

VÁLVULA ESFERA MINI M-H



Código	Medida	Caja	EAN
23501	1/4"	20	8435195801514
23502	3/8"	20	8435195801521
23503	1/2"	20	8435195801538
23504	3/4"	20	8435195801545



GRIFOS CURVOS Y ACCESORIOS

Grifo curvo esfera



124

Grifo curvo candado



125

Grifo curvo polipropileno y antihielo



125

Racor, enchufe, unión y boquilla adaptables



126

GRIFOS CURVOS

GRIFO CURVO ESFERA



Código	Medida	Caja	EAN
24506	1/2" x 3/4"	100	8435195801651
24507	3/4" x 1"	50	8435195801668
24519	3/4" x 3/4"	20	8435195832778
24508	1" x 1 1/4"	20	8435195801675
24528	1" x 1"	20	8435195832785

- PN16.
- Latón EN 12165 cromado.
- Temperatura máxima 90°C.
- Prensa estopa con guarnición de PTFE.
- Maneta de acero con PVC azul.
- Racor 2 piezas conexión manguera.
- Rompe chorros en Nylon.

GRIFO CURVO ESFERA RACOR RÁPIDO MANGUERA



Código	Medida	Caja	EAN
24522	1/2" x 3/4"	40	8435195822281
24523	3/4" x 1"	20	8435195822298
24524	3/4" x 3/4"	10	8435195822304

- PN16.
- Latón EN 12165 cromado.
- Temperatura máxima 90°C.
- Prensa estopa con guarnición de PTFE.
- Maneta de acero con PVC azul.
- Racor rápido conexión manguera.

GRIFO CURVO ESFERA SALIDA DOBLE RACOR RÁPIDO MANGUERA



Código	Medida	Caja	EAN
24509	1/2" x 3/4"	100	8435195801651

- PN16.
- Latón EN 12165 cromado.
- Temperatura máxima 90°C.
- Prensa estopa con guarnición de PTFE.
- Maneta de acero con PVC azul.
- Racor rápido conexión manguera.

GRIFOS CURVOS

GRIFO CURVO PARA CANDADO



Código	Medida	Caja	EAN
24525	1/2" x 3/4"	40	8435195822250

- PN16.
- Latón EN 12165 cromado.
- Temperatura máxima 90°C.
- Prensa estopa con guarnición de PTFE.
- Maneta de acero con PVC rojo.
- Racor 2 piezas conexión manguera.

GRIFO CURVO POLIPROPILENO



Código	Medida	Caja	EAN
24503	1/2" x 3/4"	40	8435195801620
24504	3/4" x 1"	25	8435195801637
24505	1" x 1 1/4"	15	8435195801644

- PN16.
- Temperatura: de 0°C. a 75°C.
- Prensa estopa con guarnición de PTFE con junta tórica NBR.
- Maneta de aluminio con PVC rojo.
- Conexión manguera.
- No adecuado para gas.

GRIFO CURVO ANTIHIELO NÓRDICO



Código	Medida	Caja	EAN
24500	1/2" x 3/4"	40	8435195820065
24501	3/4" x 1"	25	8435195820072
24502	1" x 1 1/4"	15	8435195820089

- PN16.
- Temperatura: de -20°C. a +75°C.
- Prensa estopa con guarnición de PTFE con junta tórica NBR.
- Maneta de aluminio con PVC azul.
- Conexión manguera.
- No adecuado para gas.
- Resistente al hielo.



GRIFOS CURVOS

Accesorios

RACOR DOS PIEZAS NÍQUEL



Código	Medida	Caja	EAN
71504	1/2" x 3/4"	25	8435195811681
71505	3/4" x 1"	25	8435195811698
71507	1" x 1"	25	8435195826708
71506	1" x 1 1/4"	25	8435195811704

RACOR H SISTEMA ANCLAJE ADAPTABLE S/COLOR



Código	Medida	Caja	EAN
24541	3/4"	10	8435195822311

RACOR H SISTEMA ANCLAJE ADAPTABLE NÍQUEL



Código	Medida	Caja	EAN
24544	3/4"	10	8435195822335
24545	1"	10	8435195822342

ENCHUFE ADAPTABLE A MANGUERA S/COLOR



Código	Medida	Caja	EAN
24546	1/2"	10	8435195828023
24547	3/4"	10	8435195822359

UNIÓN MANGUERA - MANGUERA S/COLOR



Código	Medida	Caja	EAN
24549	1/2"	10	8435195828030
24550	3/4"	10	8435195822373

BOQUILLA GRADUABLE CONTROL DE SALIDA S/COLOR



Código	Medida	Caja	EAN
24553	9,5 Ø	10	8435195822397

- Adaptable a enchufe manguera rápido.

GRIFOS DECORATIVOS

Grifos decorativos



128



GRIFOS DECORATIVOS

GRIFO JARDÍN "RENACIMIENTO"



Cód. **24531**

Caja: 10 uds.

EAN 8435195822403

GRIFO JARDÍN "RENACIMIENTO"



Cód. **1125**

Caja: 10 uds.

EAN 8435195834086

GRIFO JARDÍN "PATO"



Cód. **24532**

Caja: 10 uds.

EAN 8435195822410

GRIFO JARDÍN "PÁJARO"



Cód. **24533**

Caja: 10 uds.

EAN 8435195822427

GRIFO JARDÍN "RANA"



Cód. **24534**

Caja: 10 uds.

EAN 8435195822434

GRIFO JARDÍN "PEZ"



Cód. **24535**

Caja: 10 uds.

EAN 8435195822441

GRIFO JARDÍN "GALLO"



Cód. **24536**

Caja: 10 uds.

EAN 8435195822458

GRIFOS DECORATIVOS

GRIFO CODILLO S/COLOR



	Código	Medida	Caja	EAN
Sin racor	24510	1/2"	10	8435195801682
	24512	3/4"	10	8435195801699



	Código	Medida	Caja	EAN
Con racor	24515	1/2"	10	8435195801729
	24516	3/4"	10	8435195801736
	24526	3/4" x 1"	10	8435195833966

GRIFO CODILLO CROMADO



	Código	Medida	Caja	EAN
Sin racor	24513	1/2"	10	8435195801705
	24514	3/4"	10	843519581712



	Código	Medida	Caja	EAN
Con racor	24517	1/2"	10	8435195801743
	24518	3/4"	10	8435195801750

PLACA ATORNILLAR CROMADA



Código	Medida	Caja	EAN
25519	M-H 1/2"	10	8435195801989
25521	H-H 1/2"	10	8435195802009

GRIFO DE LATÓN PARA BARRIL



Código	Descripción	Caja	EAN
24520	Cón cánula	20	8435195820300
24521	Sin cánula	20	8435195820317



REDUCTORES DE PRESIÓN Y MANÓMETROS

Reductores de presión



132

Manómetros



133

REDUCTORES DE PRESIÓN

REDUCTOR DE PRESIÓN CON RACORES H-H



Código	Medida	Caja	EAN
25601	1/2"	5	8435195802016
25602	3/4"	5	8435195802023
25603	1"	5	8435195802030
25604	1 1/4"	4	8435195802047
25605	1 1/2"	4	8435195802054
25606	2"	2	8435195802061
25607	2 1/2"	2	8435195802078
25608	3"	1	8435195824643

- Tipo de operación: pistón.
- Latón CW617N Niquelado.
- PN25.
- Regulación de 0,5 a 6 Bares.
- Pretarado a 3 bares.
- Temperatura máxima 80°C.
- Rosca H/H ISO 228
- Conexión para manómetroS 1/4".

REDUCTOR DE PRESIÓN SIN RACORES H-H



Código	Medida	Caja	EAN
25615	3/4"	5	8435195835786
25631	1"	5	8435195832808
25632	1 1/4"	2	8435195832815
25633	1 1/2"	2	8435195832822
25634	2"	2	8435195832839

- Tipo de operación: pistón.
- Latón CW617N
- PN25.
- Regulación de 0,5 a 6 Bares.
- Pretarado a 3 bares.
- Temperatura máxima 80°C.
- Rosca H/H ISO 228
- Conexión para manómetroS 1/4".

REDUCTOR DE PRESIÓN CON RACORES M-M



Código	Medida	Caja	EAN
25612	3/4"	1	8435195848052

- Tipo de operación: pistón.
- Latón CW617N Niquelado.
- PN25.
- Regulación de 0,5 a 6 Bares.
- Pretarado a 3 bares.
- Temperatura máxima 80°C.
- Rosca M/M ISO 228
- Conexión para manómetroS 1/4".

REDUCTOR DE PRESIÓN PARA CALENTADOR DE AGUA



Código	Medida	Caja	EAN
25610	1/2"	5	
25630	3/4"	5	8435195832792

- Tipo de operación: pistón.
- Latón CW617N-DW Niquelado.
- PN16.
- De 1 a 4 Bares.
- Pretarado a 3 bares.
- Temperatura máxima 80°C.
- Rosca H/H ISO 228.
- Conexión para manómetroS 1/4".

REDUCTORES DE PRESIÓN

Manómetros

DISPOSITIVO ANTI GOLPE DE ARIETE



Código	Medida	Caja	EAN
25611	1/2"	1	8435195824650

- PN10.
- Temperatura máxima 100°C.
- Fabricado en latón. Muelle de acero inox.

MANÓMETRO SALIDA INFERIOR



Código	Medida	Caja	EAN
25702	1/4" - 0 a 6 Bar.	1	8435195823233
25703	1/4" - 0 a 10 Bar.	1	8435195823240
25704	1/4" - 0 a 16 Bar.	1	8435195832846

- Caja ABS negra con esfera y aguja de aluminio. Interiores y racor en latón.
- Temperatura ambiente: -20 a +60°C. Fluido máximo: 60°C.
- Precisión CL. 1,6.

MANÓMETRO SALIDA POSTERIOR



Código	Medida	Caja	EAN
25712	1/4" - 0 a 6 Bar.	1	8435195823257
25713	1/4" - 0 a 10 Bar.	1	8435195823264

- Caja ABS negra con esfera y aguja de aluminio. Interiores y racor en latón.
- Temperatura ambiente: -20 a +60°C. Fluido máximo: 60°C.
- Precisión CL. 1,6.

MANÓMETRO SALIDA INFERIOR CON GLICERINA



Código	Medida	Caja	EAN
25725	1/4"x63 - 0 a 6 Bar.	1	843519583283
25726	1/4"x63 - 0 a 10 Bar.	1	8435195832860
25730	1/4"x63 - 0 a 40 Bar.	1	8435195835892
25729	1/4"x63 - 0 a 60 Bar.	1	8435195835885
25727	1/4"x100-0 a 10 Bar	1	8435195832877
25728	1/4"x100-0 a 40 Bar	1	8435195835878

- Caja acero inox. con esfera ABS y aguja de aluminio. Interiores y racor en latón.
- Temperatura ambiente: -20 a +60°C. Fluido máximo: 60°C.
- Precisión CL. 1,6.

MANÓMETRO SALIDA POSTERIOR CON GLICERINA





Código	Medida	Caja	EAN
25742	1/4" x 63 - 0 a 6 Bar.	1	8435195832884
25743	1/4"x63 - 0 a 10 Bar.	1	8435195832891

- Caja acero inox. con esfera ABS y aguja de aluminio. Interiores y racor en latón.
- Temperatura ambiente: -20 a +60°C. Fluido máximo: 60°C.
- Precisión CL. 1,6.



VÁLVULAS DE RETENCIÓN Y FILTROS

Válvulas de retención H-H		136
Filtros		137
Válvulas de retención M-M		137
Válvulas de retención clapeta		138
Filtro colador tipo "Y"		138
Válvulas de compuerta		138
Válvulas esfera 3 vías		139
Válvulas esfera con retención incorporada		139
Válvulas esfera contador y accesorios		140

VÁLVULAS DE RETENCIÓN Y FILTROS

VÁLVULA DE RETENCIÓN TIPO "YORK" H-H



Código	Medida	Caja	EAN
26003	1/2"	50	8435195802092
26004	3/4"	50	8435195802108
26005	1"	40	8435195802115
26006	1 1/4"	20	8435195802122
26007	1 1/2"	20	8435195802139
26008	2"	10	8435195802146
26009	2 1/2"	1	8435195802153
26010	3"	1	8435195802160
26011	4"	1	8435195802177

- PN12 (3/8" a 1") PN10 (1 1/4" a 2") PN8 (2 1/2" a 4").
- Fabricado en latón.
- Disco de Nylon y muelle en acero inox.
- Temperatura máxima: 90°C.
- Cierre con goma NBR.

VÁLVULA DE RETENCIÓN CON FILTRO



Código	Medida	Caja	EAN
26016	1/2"	20	8435195824377
26017	3/4"	20	8435195824384
26018	1"	10	8435195824391
26019	1 1/4"	5	8435195824407
26020	1 1/2"	5	8435195824414
26021	2"	5	8435195824421
26022	2 1/2"	1	8435195824438
26023	3"	1	8435195824445
26024	4"	1	8435195824636

- PN16 (1/2" a 1") PN10 (1 1/4" a 2") PN8 (2 1/2" a 4").
- Fabricado en latón.
- Disco de Nylon.
- Muelle y filtro en acero inox.
- Temperatura máxima: 80°C.
- Cierre con goma NBR.

VÁLVULA RETENCIÓN CIERRE METÁLICO H-H



Código	Medida	Caja	EAN
26101	3/8"	10	8435195826715
26102	1/2"	50	8435195802191
26103	3/4"	40	8435195802207
26104	1"	40	8435195802214
26105	1 1/4"	20	8435195802221
26106	1 1/2"	20	8435195802238
26107	2"	10	8435195802245
26108	2 1/2"	1	8435195802252
26109	3"	1	8435195802269
26110	4"	1	8435195826722

- PN25 (3/8" a 1") PN16 (1 1/4" a 2") PN10 (2 1/2" a 4").
- Fabricado en latón.
- Disco y guía de latón.
- Temperatura máxima: 80°C.
- Cierre con goma NBR.

VÁLVULAS DE RETENCIÓN Y FILTROS

VÁLVULA RETENCIÓN M-M



Código	Medida	Caja	EAN
26202	1/2"	50	8435195822465
26203	3/4"	40	8435195822472
26204	1"	5	8435195826739

- PN16.
- Fabricado en latón.
- Disco de nylon.
- Roscas Macho - Macho.
- Temperatura máxima: 80°C.

FILTRO ACERO INOXIDABLE



Código	Medida	Caja	EAN
26503	1/2"	50	8435195802276
26504	3/4"	50	8435195802283
26505	1"	20	8435195802290
26506	1 1/4"	10	8435195802306
26507	1 1/2"	10	8435195802313
26508	2"	10	8435195802320
26509	2 1/2"	2	8435195802337
26510	3"	2	8435195802344
26511	4"	2	8435195802351

- Racor de Nylon.
- Malla de acero inoxidable:
de 1/2" a 2" perforada a 1,2 mm.
de 2 1/2" a 4" perforada a 2 mm.
- Para agua, aire y fluidos no agresivos.
- Para válvulas de retención con rosca Hembra - Hembra.

FILTRO ABS



Código	Medida	Caja	EAN
26516	1/2"	50	8435195802368
26517	3/4"	50	8435195802375
26518	1"	20	8435195802382
26519	1 1/4"	10	8435195802399
26520	1 1/2"	10	8435195802405
26521	2"	10	8435195802412

- Para válvulas de retención con rosca Hembra - Hembra.

VÁLVULAS DE RETENCIÓN Y FILTROS

VÁLVULA RETENCIÓN CLAPETA H-H



Código	Medida	Caja	EAN
26601	1/2"	50	8435195802429
26602	3/4"	50	8435195802436
26603	1"	20	8435195802443
26604	1 1/4"	10	8435195802450
26605	1 1/2"	10	8435195802467
26606	2"	10	8435195802474
26607	2 1/2"	2	8435195802481
26608	3"	2	8435195802498
26609	4"	2	8435195802504

- PN16 (1/2" a 1") PN10 (1 1/4" a 2") PN8 (2 1/2" a 4").
- Fabricado en latón.
- Clapeta de latón.
- Temperatura máxima: 90°C.
- Cierre con goma NBR.

FILTRO COLADOR TIPO "Y" H-H



Código	Medida	Caja	EAN
26613	1/2"	30	8435195802511
26614	3/4"	20	8435195802528
26615	1"	10	8435195802535
26616	1 1/4"	6	8435195802542
26617	1 1/2"	4	8435195802559
26618	2"	2	8435195802566
26619	2 1/2"	1	8435195820553
26620	3"	1	8435195820560
26621	4"	1	8435195820577

- PN16.
- Fabricado en latón.
- Filtro de acero inoxidable.
- Temperatura máxima: 100°C.

VÁLVULA COMPUERTA CON CIERRE DE GOMA H-H



Código	Medida	Caja	EAN
26622	1/2"	10	8435195822489
26623	3/4"	10	8435195822496
26624	1"	5	8435195822502
26625	1 1/4"	5	8435195822519
26626	1 1/2"	5	8435195822526
26627	2"	2	8435195822533
26628	2 1/2"	1	8435195822540
26629	3"	1	8435195822557
26630	4"	1	8435195822564

- PN16.
- Fabricado en latón.
- Cierre compuerta latón + NBR vulcanizado.
- Temperatura máxima: 80°C.
- Maneta roja de acero.

VÁLVULAS DE RETENCIÓN Y FILTROS

VÁLVULA COMPUERTA CON CIERRE DE LATÓN H-H



Código	Medida	Caja	EAN
26640	1/2"	10	8435195822571
26641	3/4"	10	8435195822588
26642	1"	5	8435195822595
26643	1 1/4"	5	8435195822601
26644	1 1/2"	5	8435195822618
26645	2"	2	8435195822625
26646	2 1/2"	1	8435195822632
26647	3"	1	8435195822649
26648	4"	1	8435195822656

- PN10.
- Fabricado en latón.
- Cierre disco de latón.
- Temperatura máxima: 110°C.
- Maneta roja de acero.

VÁLVULA ESFERA 3 VÍAS PASO "T"



Código	Medida	Caja	EAN
22552	1/2"	10	8435195835380
22553	3/4"	10	8435195835397
22554	1"	5	8435195835403
22555	1 1/4"	5	8435195835410
22556	1 1/2"	1	8435195835427
22557	2"	1	8435195835434

- PN16.
- Temperatura máxima: 130°C.
- Válvula con bola de latón.

VÁLVULA ESFERA 3 VÍAS PASO "L"



Código	Medida	Caja	EAN
22542	1/2"	10	8435195835311
22543	3/4"	10	8435195835328
22544	1"	5	8435195835335
22545	1 1/4"	5	8435195835342
22546	1 1/2"	1	8435195835359
22547	2"	1	8435195835366

- PN16.
- Temperatura máxima: 130°C.
- Válvula con bola de latón.

VÁLVULA ESFERA CON RETENCIÓN INCORPORADA



Código	Medida	Caja	EAN
26660	1/2"	10	8435195823271
26661	3/4"	10	8435195823288
26662	1"	5	8435195823295

- PN16.
- Latón EN 12165 niquelado.
- Prensa estopa con guarnición de PTFE.
- Temperatura máxima: 95°C.
- Cierre retención EPDM.
- Muelle en acero inoxidable.

VÁLVULAS DE RETENCIÓN Y FILTROS

VÁLVULA ESFERA ENTRADA CONTADOR ORIENTABLE



Código	Medida	Caja	EAN
26666	DN15 Racor 3/4"	10	8435195823301
26667	DN15 Racor 7/8"	10	8435195824698

- Cuerpo, esfera, conexiones y eje fabricado en latón.
- Brida orientable que permite su colocación en cualquier batería.
- Juntas tóricas NBR y juntas de teflón PTFE.

VÁLVULA ESFERA ENTRADA CONTADOR ORIENTABLE



Código	Medida	Caja	EAN
26676	DN15 Racor 3/4"	10	8435195826746

- Cuerpo, esfera, conexiones y eje fabricado en latón.
- Brida orientable que permite su colocación en cualquier batería.
- Juntas tóricas NBR y juntas de teflón PTFE.

VÁLVULA ESFERA SALIDA CONTADOR ANTIRRETORNO



Código	Medida	Caja	EAN
26675	DN15 Racor 3/4"	10	8435195823332

- Cuerpo, esfera, conexiones y eje fabricado en latón.
- Provista de dispositivo antirretorno en la salida.
- Juntas tóricas NBR y juntas de teflón PTFE.

MANGUITO CONTADOR



Código	Medida	Caja	EAN
26670	DN20 Racor 3/4"	10	8435195823318
26671	DN15 Racor 7/8"	10	8435195823325
26673	DN15 Racor 3/4"	10	8435195824704
26678	Racor 3/4" Izq. - 7/8" Drch.	10	8435195836226

JUNTA CAUCHO BRIDA ORIENTABLE



Código	Medida	Caja	EAN
99344	Única	10	8435195832907

CUERPO BRIDA NÍQUEL







Código	Medida	Caja	EAN
99083	3/4"	5	8435195823363

LATERAL BRIDA NÍQUEL



Código	Medida	Caja	EAN
99093	3/4"	5	8435195823400

RACORES DE CONTADOR Y ACCESORIOS

Racores de contador y accesorios		142
Racor telescópico		142
Purgador con tornillo		142
Hornacina para contador		142

RACORES DE CONTADOR Y ACCESORIOS

RACOR CONTADOR ROSCAR (Racor, tuerca y junta)



Código	Medida	Caja	EAN
99522	1/2" x 1/2"	25	8435195816617
98080	5/8" x 1/2"	25	8435195816624
89081A	3/4" x 1/2"	25	8435195816631
89083	7/8" x 1/2"	25	8435195816648
89085A	1" x 3/4"	10	8435195816655
89076	1 1/4" x 1"	5	8435195816662
89077	1 1/2" x 1 1/4"	5	8435195816679
89078	2" x 1 1/2"	2	8435195816686
98079	2 1/2" x 2"	2	8435195816693

RACOR CONTADOR SOLDAR (Racor, purgador, tuerca y junta)



Código	Medida	Caja	EAN
89080A	7/8" x 18/22	25	8435195816709
89083A	3/4" x 18	25	8435195816716

RACOR TELESCÓPICO



Código	Medida	Caja	EAN
98061	7/8" x 3/4" x 90 mm.	5	8435195824872
98101	3/4" x 3/4" x 66 mm.	5	8435195824711
98105	3/4" x 3/4" x 90 mm.	5	8435195826753

PURGADOR CON TORNILLO S/COLOR



Código	Medida	Caja	EAN
89090	1/8"	25	8435195816730

JUNTAS PARA RACOR CONTADOR



Código	Medida	Caja	EAN
83604	1/2" - 14 x 18,5 x 2	100	8435195822663
89092	3/4" - 17 x 23,5 x 2,5	100	8435195816754
89101	5/8" - 21 x 14 x 2	100	8435195816785
89093	7/8" - 21 x 27 x 2,5	100	8435195816761
84510	7/8" - 22 x 27 x 2,5	100	8435195816778
89091	1" - 22 x 30 x 2,5	100	8435195816747
83511	1 1/4" - 29 x 38 x 2,5	25	8435195824145
83512	1 1/2" - 35 x 45 x 3	25	8435195825152
83513	2" - 44 x 55 x 3	25	8435195825169
83510	2 1/2" - 50 x 69 x 4	10	8435195823424

HORNACINA CONTADOR ACERO INOX.



Código	Medida	Caja	EAN
90091	400 x 300 x 110	1	8435195816792

• Tiene 2 entradas.

ACCESORIOS PARA TUBO DE POLIETILENO

Anillo de latón		144
Anillo de acero inox. con bridas		146
Recambios		148

ACCESORIOS TUBO POLIETILENO

Anillo de latón

RACOR RECTO HEMBRA A TUBO anillo de latón



Código	Medida	Caja	EAN
30013	1/2" x 20 Ø	40	8435195802771
30014	3/4" x 25 Ø	20	8435195802788
30015	1" x 32 Ø	15	8435195802795
30016	1 1/4" x 40 Ø	8	8435195802801
30017	1 1/2" x 50 Ø	10	8435195802818
30018	2" x 63 Ø	6	8435195802825

RACOR RECTO MACHO A TUBO anillo de latón

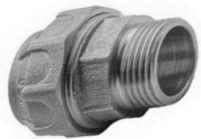

Código	Medida	Caja	EAN
31513	1/2" x 20 Ø	40	8435195802924
31514	3/4" x 25 Ø	20	8435195802931
31515	1" x 32 Ø	15	8435195802948
31516	1 1/4" x 40 Ø	8	8435195802955
31517	1 1/2" x 50 Ø	10	8435195802962
31518	2" x 63 Ø	6	8435195802979

RACOR RECTO UNIÓN TUBO A TUBO anillo de latón

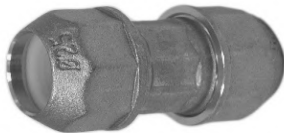

Código	Medida	Caja	EAN
33013	20 x 20 Ø	25	8435195803075
33014	25 x 25 Ø	15	8435195803082
33015	32 x 32 Ø	10	8435195803099
33016	40 x 40 Ø	5	8435195803105
33017	50 x 50 Ø	6	8435195803112
33018	63 x 63 Ø	4	8435195803129

RACOR CODO HEMBRA A TUBO anillo de latón



Código	Medida	Caja	EAN
37513	1/2" x 20 Ø	30	8435195803501
37514	3/4" x 25 Ø	18	8435195803518
37515	1" x 32 Ø	10	8435195803525
37516	1 1/4" x 40 Ø	5	8435195803532
37517	1 1/2" x 50 Ø	6	8435195803549
37518	2" x 63 Ø	4	8435195803556

RACOR CODO MACHO A TUBO anillo de latón



Código	Medida	Caja	EAN
36013	1/2" x 20 Ø	30	8435195803358
36014	3/4" x 25 Ø	18	8435195803365
36015	1" x 32 Ø	10	8435195803372
36016	1 1/4" x 40 Ø	5	8435195803389
36017	1 1/2" x 50 Ø	6	8435195803396
36018	2" x 63 Ø	4	8435195803402

ACCESORIOS TUBO POLIETILENO

Anillo de latón

RACOR CODO UNIÓN TUBO A TUBO anillo de latón



Código	Medida	Caja	EAN
34513	20 x 20 Ø	20	8435195803211
34514	25 x 25 Ø	10	8435195803228
34515	32 x 32 Ø	8	8435195803235
34516	40 x 40 Ø	3	8435195803242
34517	50 x 50 Ø	5	8435195803259
34518	63 x 63 Ø	3	8435195803266

RACOR CODO PLACA HEMBRA A TUBO



	Código	Medida	Caja	EAN
Anillo latón	37519	1/2" x 20 Ø	20	8435195803563
	37520	3/4" x 25 Ø	12	8435195803570
	37521	1" x 32 Ø	8	8435195803587

	Código	Medida	Caja	Código Barras
Anillo nylon	37525	1/2" x 20 Ø	20	8435195826760
	37526	3/4" x 25 Ø	8	8435195826777

RACOR TE HEMBRA A TUBO anillo de latón



Código	Medida	Caja	EAN
38013	1/2" x 20 Ø	18	8435195803686
38014	3/4" x 25 Ø	10	8435195803693
38015	1" x 32 Ø	6	8435195803709
38016	1 1/4" x 40 Ø	4	8435195803716
38017	1 1/2" x 50 Ø	4	8435195803723
38018	2" x 63 Ø	2	8435195803730

RACOR TE UNIÓN TUBO A TUBO anillo de latón



Código	Medida	Caja	EAN
39013	20 x 20 x 20 Ø	12	8435195803884
39014	25 x 25 x 25 Ø	8	8435195803891
39015	32 x 32 x 32 Ø	4	8435195803907
39016	40 x 40 x 40 Ø	3	8435195803914
39017	50 x 50 x 50 Ø	3	8435195803921
39018	63 x 63 x 63 Ø	2	8435195803938



ACCESORIOS TUBO POLIETILENO

Anillo de acero inoxidable con bridas

RACOR RECTO HEMBRA A TUBO anillo inox. con bridas



Código	Medida	Caja	EAN
30009	2 1/2" x 75 Ø	4	8435195802740
30010	3" x 90 Ø	2	8435195802757
30011	4" x 110 Ø	2	8435195802764

RACOR RECTO MACHO A TUBO anillo inox. con bridas



Código	Medida	Caja	EAN
31509	2 1/2" x 75 Ø	4	8435195802894
31510	3" x 90 Ø	2	8435195802900
31511	4" x 110 Ø	2	8435195802917

RACOR RECTO UNIÓN TUBO A TUBO anillo inox. con bridas



Código	Medida	Caja	EAN
33009	75 x 75 Ø	4	8435195803044
33010	90 x 90 Ø	2	8435195803051
33011	110 x 110 Ø	1	8435195803068

RACOR CODO HEMBRA A TUBO anillo inox. con bridas



Código	Medida	Caja	EAN
37509	2 1/2" x 75 Ø	2	8435195803471
37510	3" x 90 Ø	2	8435195803488
37511	4" x 110 Ø	2	8435195803495

RACOR CODO MACHO A TUBO anillo inox. con bridas



Código	Medida	Caja	EAN
36009	2 1/2" x 75 Ø	2	8435195803334
36010	3" x 90 Ø	2	8435195803341

ACCESORIOS TUBO POLIETILENO

Anillo de acero inoxidable con bridas

RACOR CODO UNIÓN TUBO A TUBO anillo inox. con bridas



Código	Medida	Caja	EAN
34509	75 x 75 Ø	2	8435195803198
34510	90 x 90 Ø	2	8435195803204

RACOR TE HEMBRA A TUBO anillo inox. con bridas



Código	Medida	Caja	EAN
38009	2 1/2" x 75 Ø	1	8435195803662
38010	3" x 90 Ø	1	8435195803679
38011	4" x 110 Ø	1	8435195803686

RACOR TE UNIÓN TUBO A TUBO anillo inox. con bridas



Código	Medida	Caja	EAN
39009	75 x 75 x 75 Ø	1	8435195803860
39010	90 x 90 x 90 Ø	1	8435195803877

ACCESORIOS TUBO POLIETILENO

Recambios

ANILLO ABIERTO NYLON



Código	Medida	Caja	EAN
39025	20 Ø	10	8435195820645
39026	25 Ø	10	8435195820652
39027	32 Ø	10	8435195820669
39028	40 Ø	10	8435195820676
39029	50 Ø	10	8435195820683
39030	63 Ø	10	8435195820690

ARANDELA NYLON



Código	Medida	Caja	EAN
39060	20 Ø	10	8435195820845
39061	25 Ø	10	8435195820852
39062	32 Ø	10	8435195820869
39063	40 Ø	10	8435195820876
39064	50 Ø	10	8435195820883
39065	63 Ø	10	8435195820890

ANILLO ABIERTO LATÓN



Código	Medida	Caja	EAN
39019	20 Ø	10	8435195820584
39020	25 Ø	10	8435195820591
39021	32 Ø	10	8435195820607
39022	40 Ø	10	8435195820614
39023	50 Ø	10	8435195820621
39024	63 Ø	10	8435195820638

ARANDELA LATÓN

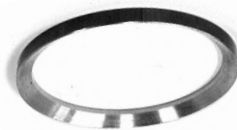



Código	Medida	Caja	EAN
39050	20 Ø	10	8435195820784
39051	25 Ø	10	8435195820791
39052	32 Ø	10	8435195820807
39053	40 Ø	10	8435195820814
39054	50 Ø	10	8435195820821
39055	63 Ø	10	8435195820838

JUNTA TÓRICA



Código	Medida	Caja	EAN
39031	20 Ø	10	8435195820706
39032	25 Ø	10	8435195820713
39033	32 Ø	10	8435195820720
39034	40 Ø	10	8435195820737
39035	50 Ø	10	8435195820744
39036	63 Ø	10	8435195820751

GRIFOS FLOTADORES Y BOYAS

Flotadores		150
Boyas		152
Accesorios		154

GRIFOS FLOTADORES Y BOYAS

GRIFO FLOTADOR CAZOLETA



Código	Medida	Caja	EAN
57501	3/8"	100	8435195808025
57502	1/2"	50	8435195808032

	Código	Descripción	EAN
Recambio	58517	Varilla 220 mm. Rosca 3/16	8435195820348

GRIFO FLOTADOR GUÍA VARILLA REDONDA



Código	Medida	Caja	EAN
58002	3/8" 3/16 inox.	25	8435195832990
58003	1/2" 6/100	25	8435195808049
58004	3/4" 6/100	25	8435195808056
58005	1" 8/100	25	8435195808063
58006	1 1/4" 9/100	10	8435195808070
58007	1 1/2" 9/100	10	8435195808087
58008	2" 9/100	5	8435195808094

GRIFO FLOTADOR ACERO INOX. CIERRE SILICONA

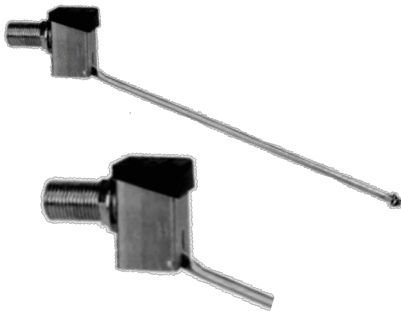

Código	Medida	Caja	EAN
58040	3/8" 6/100	1	8435195840865
58041	1/2" 6/100	1	8435195833003
58042	3/4" 8/100	1	8435195833010
58043	1" 8/100	1	8435195833027
58044	1 1/4" 8/100	1	8435195833034

- Fabricado en acero inoxidable AISI 304.
- Conexión rosca gas.
- Presión máxima de trabajo 10 Kg/cm.
- Cierre de silicona.
- Paso total.

GRIFO FLOTADOR GUÍA VARILLA ARTICULADA

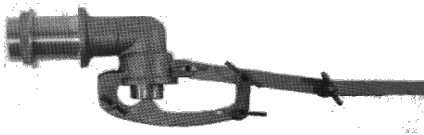

Código	Medida	Caja	EAN
58016	1/2" 6/100	25	8435195808131
58017	3/4" 6/100	25	8435195808148
58018	1" 8/100	25	8435195808155

GRIFO FLOTADOR GUÍA VARILLA DESLIZANTE

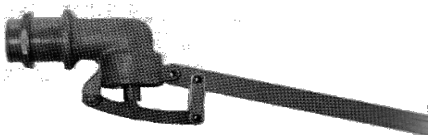

Código	Medida	Caja	EAN
58019	1/2"	25	8435195808162
58020	3/4"	25	8435195808179
58021	1"	25	8435195808186
58022	1 1/4"	10	8435195808193
58023	1 1/2"	10	8435195808209
58024	2"	5	8435195808216
58025	2 1/2"	1	8435195808355
58026	3"	1	8435195808362

GRIFOS FLOTADORES Y BOYAS

GRIFO FLOTADOR SILENCIOSO MACHO



Código	Medida		Caja	EAN
57001	M 3/8"	Tanque alto	100	8435195808025
57002	M 3/8"	Tanque bajo	50	8435195808032

- Fabricado en latón niquelado.

GRIFO FLOTADOR SILENCIOSO HEMBRA



Código	Medida		Caja	EAN
57003	H 3/8"	Tanque alto	50	8435195808032

- Fabricado en latón niquelado.

GRIFO FLOTADOR TELESCÓPICO VERTICAL CON BOYA



Código	Medida		Caja	EAN
57011	M 3/8"	Tanque alto	10	8435195807998

- Altura regulable.

GRIFO FLOTADOR TELESCÓPICO LATERAL CON BOYA



Código	Medida		Caja	EAN
57007	M 3/8"	Tanque alto	10	8435195807981

- Altura regulable.

GRIFO FLOTADOR COMPACTO DUO



Código	Medida		Caja	EAN
57015	M 3/8"		10	8435195848076

- Flotador para cisterna con toma baja o toma lateral.
- Altura regulable.
- Con boya integrada.

GRIFO FLOTADOR VERTICAL



Código	Medida		Caja	EAN
57013	M 3/8"		10	8435195808001

- Altura regulable.

GRIFO FLOTADOR LATERAL



Código	Medida		Caja	EAN
57014	M 3/8"		10	8435195808018

- Altura regulable.

GRIFOS FLOTADORES Y BOYAS

BOYA DE POREXPAN CILÍNDRICA CON SOPORTE GUÍA



Código	Medida	Caja	EAN
58500	3/8" 3/16. 70 x 80 Ø	40	8435195808223

- Para grifo flotador cazoleta.
- Para grifo flotador silencioso.

BOYA DE POREXPAN ESFÉRICA



Código	Medida	Caja	EAN
58501	3/8" 3/16. 90 Ø	200	8435195808230
58502	1/2" 3/16. 110 Ø	80	8435195808247
58516	1/2" 6/100 110 Ø	80	8435195808254
58519	3/4" 6/100 130 Ø	10	8435195808906

- Para grifo flotador cazoleta.
- Para grifo flotador silencioso.

BOYA DE PLÁSTICO ESFÉRICA



Código	Medida	Caja	EAN
58508	3/8" 3/16. 90 Ø	220	8435195808261
58534	3/8" 6/100 90 Ø	220	8435195840964
58537	1/2" 3/16. 110 Ø	120	8435195840988
58503	1/2" 6/100 110 Ø	120	8435195808278
58504	3/4" 6/100 130 Ø	66	8435195808285
58538	3/4" 7/100 130 Ø	66	8435195840995
58539	1" 6/100 150 Ø	26	8435195841008
58505	1" 8/100 150 Ø	26	8435195808292
58506	1 1/4" 9/100 200 Ø	18	8435195808308
58507	2" 9/100 230 Ø	12	8435195808315

- Para grifo flotador guía varilla redonda.

BOYA DE PLÁSTICO PLANA



Código	Medida	Caja	EAN
58530	1/2" y 3/4" 120 Ø	66	8435195821314
58531	1" 150 Ø	26	8435195821321
58532	1 1/4", 1 1/2" y 2" 200 Ø	18	8435195821338
58533	2 1/2" y 3" 250 Ø	12	8435195821345

- Para grifo flotador guía varilla redonda y deslizante.

GRIFOS FLOTADORES Y BOYAS

BOYA DE COBRE PLANA



Código	Medida		Caja	EAN
58509	1/2"	120 Ø	25	8435195808339
58510	3/4"	150 Ø	25	8435195808346
58511	1"	170 Ø	25	8435195808353
58512	1 1/4"	200 Ø	10	8435195808360
58513	1 1/2"	230 Ø	10	8435195808377
58514	2"	250 Ø	5	8435195808384
58515	2 1/2"	280 Ø	2	8435195820287
58518	3"	300 Ø	2	8435195820294

• Para grifo flotador guía varilla redonda y deslizante.

BOYA DE LATÓN ESFÉRICA



Código	Medida		Caja	EAN
58526	3/8"	90 Ø	10	8435195826913
58520	1/2"	110 Ø	25	8435195808391
58521	3/4"	130 Ø	25	8435195808407
58522	1"	150 Ø	25	8435195808414
58523	1 1/4"	180 Ø	10	8435195808421
58524	1 1/2"	200 Ø	10	8435195808438
58525	2"	230 Ø	5	8435195808445

• Para grifo flotador guía varilla redonda.

BOYA DE ACERO INOXIDABLE ESFÉRICA



Código	Medida		Caja	EAN
58546	3/8"	90 Ø	1	8435195841053
58544	1/2"	110 Ø	1	8435195833041
58545	3/4"	160 Ø	1	8435195833058

• Para grifo flotador guía varilla redonda.



GRIFOS FLOTADORES Y BOYAS

Accesorios

JUNTA MEMBRANA FLOTADOR



Código	Medida	Caja	EAN
57016	3/8" x 18,50	25	8435195833065
57017	3/8" x 24	25	8435195833850

TUERCA ABS CON HEXÁGONO



Código	Medida	Caja	EAN
57020	3/8"	25	8435195833072
57021	1/2"	25	8435195833843

• ABS blanco.

JUNTA CIERRE TAZA TANQUE ESPECIAL



Código	Medida	Caja	EAN
72051	110 x 72 mm.	25	8435195833089

• Goma material espumoso.

JUNTA CIERRE TAZA TANQUE CISTERNA BAJA



Código	Medida	Caja	EAN
72050	97 x 57 mm.	25	8435195826920

• Caucho.

CISTERNA E INODORO

Descargadores y gomas		156
Cisterna y accesorios		159
Tiradores		160
Gomas y juntas		161
Manguitos y tapones		162
Tapas inodoro		164
Accesorios de baño		165

CISTERNA E INODORO

Descargadores y gomas

DESCARGADOR CISTERNA TANQUE ALTO



Código	Descripción	Caja	EAN
72001	PVC	10	8435195811711

CAMPANA DESCARGADOR CISTERNA TANQUE ALTO

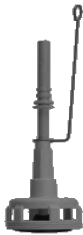

Código	Descripción	Caja	EAN
72002	PVC	10	8435195811728

REBOSADERO CON TOPE DESCARGADOR TANQUE ALTO



Código	Descripción	Caja	EAN
72003	PVC	10	8435195811735

GOMA OBTURADORA DESCARGADOR TANQUE ALTO



Código	Medida	Caja	EAN
72004	5 x 45 mm.	5	8435195811742

GOMA OBTURADORA DESCARGADOR TANQUE ALTO



Código	Medida	Caja	EAN
72046	7 x 45 mm.	10	8435195842333

GANCHILLO DESCARGADOR TANQUE ALTO



Código	Descripción	Caja	EAN
72005	Acero Inox.	10	8435195811759

GOMA CÓNICA BAJANTE CISTERNA TANQUE ALTO



Código	Medida	Caja	EAN
72012	1 1/4" x 32 mm.	10	8435195811759

CISTERNA E INODORO

Descargadores y gomas

DESCARGADOR CISTERNA TANQUE BAJO REGULABLE



Código	Descripción	Caja	EAN
72006	PVC	10	8435195811773

• Rosca universal tipo Roca.

CAMPANA DESCARGADOR CISTERNA TANQUE BAJO



Código	Descripción	Caja	EAN
72007	PVC	10	8435195811780

GOMA OBTURADORA DESCARGADOR TANQUE BAJO



Código	Medida	Caja	EAN
72008	17 x 68 mm.	100	8435195811797

GOMA OBTURADORA DESCARGADOR TANQUE BAJO



Código	Medida	Caja	EAN
72009	23 x 73	100	8435195811803

• Tipo Roca.

GOMA ASIENTO ROCA SILICONA TANQUE BAJO



Código	Medida	Caja	EAN
72010	75 x 50 mm.	100	8435195811810

BASE CON TUERCA DESCARGADOR CISTERNA TANQUE BAJO



Código	Descripción	Caja	EAN
72011	PVC	10	8435195811827

JUNTA CIERRE TAZA TANQUE CISTERNA BAJA



Código	Medida	Caja	EAN
72050	97 x 57 mm.	25	8435195826920
72051	110 x 72 mm.	25	8435195833089

CISTERNA E INODORO

Descargadores y gomas

DESCARGADOR CISTERNA DE PULSADOR SIMPLE



Código	Descripción	Caja	EAN
72039	PVC	1	8435195833096

- Compatible con el sistema Roca. (Tradicional de rosca)

DESCARGADOR CISTERNA DE PULSADOR ININTERRUMPLIBLE



Código	Descripción	Caja	EAN
72044	PVC	1	8435195833126

- Compatible con el sistema Roca. (Tradicional de rosca)

	Código	Descripción	EAN
Recambio	72045	Goma obturadora	8435195842326
	72052	Pulsador	8435195842371

DESCARGADOR CISTERNA DE DOBLE PULSADOR ORIENTABLE



Código	Descripción	Caja	EAN
72042	PVC	1	8435195833119

- Compatible con el sistema Roca. (Tradicional de rosca)
- Pulsador de accionamiento remoto (cable de acero) que puede ser ubicado en cualquier lado del tanque.
- Doble descarga, ambas regulables. (Descarga media y descarga total).
- Pulsador preparado para agujeros de cualquier dimensión.

	Código	Descripción	EAN
Recambio	72047	Goma obturadora	8435195842340
	72049	Pulsador	8435195842364

DESCARGADOR CISTERNA DE DOBLE PULSADOR UNIVERSAL



Código	Descripción	Caja	EAN
72041	PVC	1	8435195833102

- Compatible con el sistema Roca. (Tradicional de rosca)
- Doble descarga, ambas regulables. (Descarga media y descarga total).

	Código	Descripción	EAN
Recambio	72047	Goma obturadora	8435195842340
	72048	Pulsador	8435195842357

DESCARGADOR CISTERNA DE DOBLE PULSADOR UNIVERSAL



Código	Descripción	Caja	EAN
72043	PVC	1	8435195842319

- Regulable en altura.
- Doble descarga, ambas regulables. (Descarga media y descarga total).

CISTERNA E INODORO

Cisterna y accesorios

CASCO CISTERNA TANQUE ALTO



Código	Descripción	Caja	EAN
72015	ABS blanco	24	8435195811889

BAJANTE CISTERNA TANQUE ALTO



Código	Descripción	Caja	EAN
72020	ABS blanco	10	8435195801972

CONJUNTO ACCESORIOS CISTERNA TANQUE ALTO

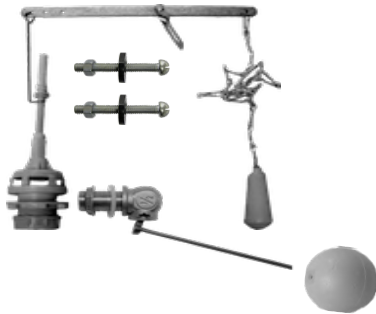

Código	Descripción	Caja	EAN
72016	Conjunto completo	10	8435195811896

• Contiene: descargador tanque alto, grifo flotador cazoleta 3/8, boya, palanca descargador, tirador tanque alto con pomo y juego tornillos.

PALANCA DESCARGADOR CISTERNA ALTA



Código	Descripción	Caja	EAN
72013	ABS	100	8435195811858



Código	Descripción	Caja	EAN
72014	Acero	200	8435195811865



Código	Descripción	Caja	EAN
72017	Acero con soporte de latón	150	8435195811872

JUEGO DOS TORNILLOS SOPORTE PALANCA



Código	Medida	Caja	EAN
72018	M5 x 35 mm.	100	8435195811902

CISTERNA E INODORO

Tiradores

TIRADOR CISTERNA TANQUE ALTO CLÁSICO



Código	Descripción	Caja	EAN
72022	ABS blanco	25	8435195811926

TIRADOR CISTERNA TANQUE ALTO PLANO



Código	Descripción	Caja	EAN
72021	ABS blanco	25	8435195811919

TIRADOR CISTERNA TANQUE ALTO BOMBILLA



Código	Descripción	Caja	EAN
72023	Cristal	25	8435195811933
72024	ABS fumé	25	8435195811940

TIRADOR CISTERNA TANQUE ALTO ANILLA



Código	Descripción	Caja	EAN
72038	ABS Blanco	25	8435195847673

TIRADOR CISTERNA TANQUE BAJO ABS



Código	Descripción	Caja	EAN
72025	Recto	25	8435195811964
72027	Curvo	25	8435195811988

TIRADOR CISTERNA TANQUE BAJO METAL



Código	Descripción	Caja	EAN
72026	Recto	25	8435195811971
72028	Curvo	25	8435195811995

CISTERNA E INODORO

Gomas y juntas

GOMA OBTURADORA TIPO ROCA ANTIGUA



Código	Medida	Caja	EAN
72030	70 x 23 x 3 mm.	50	8435195812008

GOMA OBTURADORA TIPO ROCA NUEVA



Código	Medida	Caja	EAN
72031	68 x 33 x 3 mm.	50	8435195812015

DISCO FLOTADOR TIPO ROCA



Código	Medida	Caja	EAN
72032	29 x 3 mm.	50	8435195812022

JUNTA SEMI PLANA FREGADERO



Código	Medida	Caja	EAN
72033	68 X 40 5,5 mm.	50	8435195812039

JUNTA SEMI PLANA BAÑERA



Código	Medida	Caja	EAN
72034	79 x 45 x 6,5 mm.	50	8435195812046



CISTERNA E INODORO

Manguitos WC

MANGUITO FLEXIBLE LABIADO INODORO



	Código	Medida	Caja	EAN
Recto	25543	110 Ø	10	8435195828245



	Código	Medida	Caja	EAN
Excéntrico	25544	110 Ø	10	8435195828252

MANGUITO INODORO COMPRIMIBLE

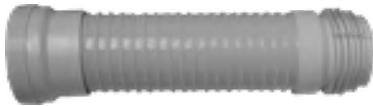

Código	Medida	Caja	EAN
63516	90/100/110 Ø x 400 mm.	18	8435195823660

MANGUITO INODORO EXTENSIBLE



Código	Medida	Caja	EAN
63505	90/100/110 Ø x 250-530 mm	25	8435195821369

MANGUITO PVC PARA INODORO



	Código	Medida	Caja	EAN
Recto	25546	90 Ø	36	8435195820546



	Código	Medida	Caja	EAN
Excéntrico	25545	90 Ø	36	8435195820539
	25547	110 Ø	36	8435195824537

CISTERNA E INODORO

Manguitos WC

GOMA MANGUITO



	Código	Medida	Caja	EAN
Superior	25548	90 Ø	1	8435195827897



	Código	Medida	Caja	EAN
Labiada	25549	90 Ø	1	843519582703

TAPÓN MACHO ABS



Código	Medida	Caja	EAN
74007	3/8"	100	8435195812251
74005	1/2"	100	8435195812268
74006	3/4"	50	8435195812275
74010	1 1/2"	10	8435195842500
74011	2"	10	8435195842517

TAPÓN HEMBRA ABS



Código	Medida	Caja	EAN
74008	1/2"	250	8435195847697
74009	3/4"	200	8435195847703
74001	1"	150	8435195847680
70046	1 1/2"	10	8435195842142

CISTERNA E INODORO

Tapas inodoro

TAPA INODORO UNIVERSAL

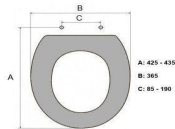

Código	Descripción	Caja	EAN
98097	PP	12	8435195801996

- Incluye juego de tornillos de fijación.
- Tapa de gran calidad, con diseño cómodo, resistente y de fácil montaje.
- Con herraje regulable.
- Adaptable a la mayoría de inodoros comunes del mercado.

Recambio	Código	Descripción	Caja	EAN
	99248	Juego de tornillos	10	8435195822854

TAPA INODORO CONTINENTAL

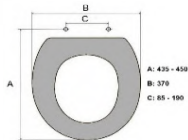

Código	Descripción	Caja	EAN
98098	PP	10	8435195812053

- Incluye juego de tornillos de fijación.
- Tapa de gran calidad, con diseño cómodo, resistente y de fácil montaje.
- Con herraje de acero inoxidable y regulable.
- Adaptable a la mayoría de inodoros comunes del mercado.

Recambio	Código	Descripción	Caja	EAN
	98099	Juego de tornillos	10	8435195822861

TAPA INODORO LUCIAN

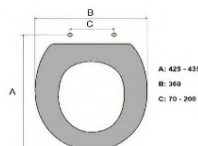

Código	Descripción	Caja	EAN
98090	ABS	10	8435195822878

- Incluye juego de tornillos de fijación.
- Tapa de gran calidad, con diseño cómodo, resistente y de fácil montaje.
- Con herraje de acero inoxidable y regulable.
- Adaptable a la mayoría de inodoros comunes del mercado.

Recambio	Código	Descripción	Caja	EAN
	98091	Juego de tornillos	10	8435195822885

CISTERNA E INODORO

Accesorios de baño

PORTAESCOBILLAS COMPLETO



Código	Descripción	Caja	EAN
98093	ABS	12	8435195822892

ESCOBILLA



Código	Descripción	Caja	EAN
98094	ABS	1	8435195822908

TABURETE DE BAÑO



Código	Descripción	Caja	EAN
98095	ABS	1	8435195822915

EJE PORTARROLLOS



Código	Descripción	Caja	EAN
72019	ABS blanco	10	8435195826951



ACCESORIOS DE FIJACIÓN

Accesorios de fijación



168

ACCESORIOS DE FIJACIÓN

JUEGO 2 TORNILLOS FIJACIÓN INODORO / BIDET ACERO INOX.



Código	Medida	Caja	EAN
62001	M5 x 75 mm.	50	8435195841411

JUEGO 2 TORNILLOS FIJACIÓN INODORO / BIDET LATÓN

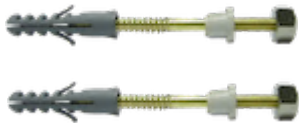

Código	Medida	Caja	EAN
62003	M5 x 75 mm.	50	8435195809534

JUEGO 2 TORNILLOS FIJACIÓN INODORO / BIDET ACERO GALVA.



Código	Medida	Caja	EAN
62002	M5 x 75 mm.	50	8435195809527

JUEGO 4 TORNILLOS FIJACIÓN INODORO / BIDET ACERO GALVA.



Código	Medida	Caja	EAN
62010	M5 x 75 mm.	25	8435195827873

JUEGO 2 TORNILLOS FIJACIÓN LATERAL INODORO



Código	Medida	Caja	EAN
99150	M6	25	8435195809565

JUEGO 2 TORNILLOS FIJACIÓN LATERAL INODORO CON EMBELLECEDOR



Código	Medida	Caja	EAN
99151	M6	25	8435195821352

JUEGO 2 TORNILLOS FIJACIÓN INODORO CON SOPORTE NYLON



Código	Medida	Caja	EAN
62015	M6	25	8435195847710

ACCESORIOS DE FIJACIÓN

JUEGO 2 TORNILLOS FIJACIÓN LAVABO ACERO



Código	Medida	Caja	EAN
62004	M8 x 90 mm.	25	8435195809541
62005	M10 x 100 mm.	25	8435195809558

JUEGO 2 TORNILLOS FIJACIÓN TAZA / TANQUE ACERO INOX



Código	Medida	Caja	EAN
62013	95 mm.	25	8435195809589

JUEGO 2 TORNILLOS FIJACIÓN TAZA / TANQUE ACERO



Código	Medida	Caja	EAN
62006	95 mm.	25	8435195809572

JUEGO 2 TORNILLOS FIJACIÓN TAZA / TANQUE NYLON



Código	Medida	Caja	EAN
62014	95 mm.	25	8435195822670

JUEGO 2 TORNILLOS FIJACIÓN SOPORTE CALENTADOR



Código	Medida	Caja	EAN
62007	M8 x 60 mm.	25	8435195809596
62008	M8 x 70 mm.	25	8435195809602

JUEGO 2 ESCUADRAS SOPORTE LAVABO



Código	Medida	Caja	EAN
63002	10 cm.	100	8435195809657

TACOS ESTRIADOS DE NYLON



Código	Medida	Caja	EAN
62502	6 Ø	100	8435195809619
62504	8 Ø	100	8435195809626
62506	10 Ø	50	8435195809633
62508	12 Ø	50	8435195809640



RACORERIA DE LATON ROSCAR

Machón doble		172
Marsella hexagonal		174
Reducción hexagonal		175
Reducción lisa		175
Codos		176
Te H-H-H		178
Manguitos		179
Tapón Hembra		180
Tapón Macho		181
Unión 3 piezas		182
Racor depósito uralita		183
Arandela hierro, latón y acero inox.		183
Tuercas correderas		184
Alargaderas cilíndricas pulidas y cromadas		184
Codo 3 bocas, cruz 4 bocas, Te 5 vías		185
Bebedero de cerdo		185
Curvas de 90°		185
Collarines		186
Maguitos electrolíticos		186

RACORERÍA DE LATÓN ROSCAR

MACHÓN DOBLE M-M (TH280)



Código	Medida	Caja	EAN
66000	1/8"	100	8435195810202
66001	1/4"	100	8435195810219
66002	3/8"	100	8435195810226
66003	1/2"	100	8435195810233
66004	3/4"	25	8435195810240
66005	1"	25	8435195810257
66006	1 1/4"	10	8435195810264
66007	1 1/2"	10	8435195810271
66008	2"	5	8435195810288
66009	2 1/2"	2	8435195810295
66015	3"	2	8435195810301
66016	4"	2	8435195810318

MACHÓN DOBLE CROMADO M-M (TH280)



Código	Medida	Caja	EAN
66010	1/4"	100	8435195810325
66011	3/8"	100	8435195810332
66012	1/2"	100	8435195810349
66013	3/4"	50	8435195810356
66014	1"	25	8435195810363
66020	1 1/4"	5	8435195827033
66021	1 1/2"	5	8435195827040

MACHÓN DOBLE REDUCIDO M-M (TH245)



Código	Medida	Caja	EAN
67017	1/8" x 3/8"	100	8435195827071
67028	1/4" x 1/8"	100	8435195810370
67000	1/4" x 3/8"	100	8435195810387
67029	1/2" x 1/4"	100	8435195810394
67001	1/2" x 3/8"	100	8435195810400
67002	3/4" x 1/2"	25	8435195810417
67033	3/4" x 7/8"	25	8435195823226
67003	1" x 3/4"	50	8435195810424
67004	1 1/4" x 1"	10	8435195810431
67005	1 1/2" x 1 1/4"	10	8435195810448
67006	2" x 1 1/2"	5	8435195810455
67007	1" x 1/2"	25	8435195810462
67008	1 1/2" x 1/2"	10	8435195810479
67030	1 1/4" x 1/2"	10	8435195810486
67015	1 1/4" x 3/4"	10	8435195810493
67020	1 1/2" x 3/4"	10	8435195810509
67021	1 1/2" x 1"	10	8435195810516
67022	2" x 3/4"	5	8435195810523
67023	2" x 1"	5	8435195810530
67024	2" x 1 1/4"	5	8435195810547
67009	2 1/2" x 1 1/4"	2	8435195827088
67014	2 1/2" x 1 1/2"	2	8435195827095
67025	2 1/2" x 2"	2	8435195810554
67026	3" x 2"	2	8435195810561
67027	3" x 2 1/2"	2	8435195810578
67031	4" x 2 1/2"	2	8435195810585
67032	4" x 3"	2	8435195810592

RACORERÍA DE LATÓN ROSCAR

MACHÓN DOBLE REDUCIDO CROMADO M-M (TH245)



Código	Medida	Caja	EAN
67010	1/2" x 3/8"	100	8435195810608
67011	3/4" x 1/2"	100	8435195810615
67012	1" x 3/4"	50	8435195810622
67041	1 1/4" x 1"	5	8435195827101
67042	1 1/2" x 1 1/4"	5	8435195827118
67043	2 x 1 1/2"	5	8435195827125
67044	1 x 1/2"	5	8435195827132
67048	1 1/2" x 3/4"	5	8435195827170
67049	1 1/2" x 1"	5	8435195827187
67052	2 x 1 1/4"	5	8435195827217

MACHÓN MONOBLOC CROMADO M-M



Código	Medida	Caja	EAN
65502	1/2" x 3/8" 32 mm.	50	8435195810172

MACHÓN MONOBLOC MEDIA ROSCA M-M



Código	Medida	Caja	EAN
65507	1/2" x 3/8" 40 mm.	25	8435195810189

MACHÓN MONOBLOC MEDIA ROSCA CROMADO M-M



Código	Medida	Caja	EAN
65508	1/2" x 3/8" 40 mm.	25	8435195810196

MACHÓN MONOBLOC CON TUERCA Y BICONO CROMADO M-M



Código	Medida	Caja	EAN
65001	1/2" x 3/8"	50	8435195810141
65002	1/2" x 3/8" 32 mm.	50	8435195810158

RACORERÍA DE LATÓN ROSCAR

MARSELLA HEXAGONAL M-H (TH529)



Código	Medida	Caja	EAN
68001	3/8"	100	8435195810639
68002	1/2"	100	8435195810646
68003	1/2" x 2 cm.	100	8435195810653
68009	1/2" x 3 cm.	25	8435195810660
68016	1/2" HEXÁGONO INTERIOR	25	8435195810776
68004	3/4"	50	8435195810677
68005	1"	25	8435195810684
68006	1 1/4"	10	8435195810691
68007	1 1/2"	5	8435195810707
68008	2"	5	8435195810714

MARSELLA HEXAGONAL CROMADA M-H (TH529)



Código	Medida	Caja	EAN
68010	3/8"	50	8435195810721
68011	1/2"	100	8435195810738
68012	1/2" x 2 cm.	100	8435195810745
68013	3/4"	50	8435195810752
68014	1"	25	8435195810769

MARSELLA HEXAGONAL REDUCIDA M-H (TH246)



Código	Medida	Caja	EAN
69023	1/8" x 1/4"	100	8435195810783
69001	3/8" x 1/2"	100	8435195810790
69020	3/8" x 3/4"	100	8435195841978
69002	1/2" x 3/8"	100	8435195810806
69003	1/2" x 3/4"	100	8435195810813
98023	1/2" x 1"	25	8435195810820
69018	1/2" x 1 1/4"	10	8435195810837
69004	3/4" x 1/2"	50	8435195810844
69005	3/4" x 1"	25	8435195810851
69017	3/4" x 1 1/4"	10	8435195810875
69019	3/4" x 2"	5	8435195810912
69024	1" x 1/2"	5	8435195824681
69006	1" x 3/4"	25	8435195810868
69007	1" x 1 1/4"	10	8435195810882
69009	1" x 1 1/2"	5	8435195810899
69022	1" x 2"	5	8435195810929
69016	1 1/4" x 1 1/2"	5	8435195810905
90092	1 1/4" x 2"	5	8435195810936
99228	1 1/2" x 2"	5	8435195810943
69008	2" x 2 1/2"	5	8435195810950

MARSELLA HEX. REDUCIDA CROMADA M-H (TH246)



Código	Medida	Caja	EAN
69010	3/8" x 1/2"	100	8435195810967
69011	1/2" x 3/8"	100	8435195810974
69012	1/2" x 3/4"	100	8435195810981
69013	3/4" x 1/2"	25	8435195810998
69014	3/4" x 1"	25	8435195811001
69015	1" x 3/4"	25	8435195811018

RACORERÍA DE LATÓN ROSCAR

REDUCCIÓN HEXAGONAL M-H (TH241)



Código	Medida	Caja	EAN
99091	1/4" x 1/8"	100	8435195809831
64000	3/8" x 1/4"	100	8435195809848
64024	1/2" x 1/8"	100	8435195809855
64001	1/2" x 1/4"	100	8435195809862
64002	1/2" x 3/8"	100	8435195809879
64003	3/4" x 1/2"	100	8435195809886
64004	1" x 1/2"	50	8435195809893
64005	1" x 3/4"	50	8435195809909
64027	1 1/4" x 1/2"	10	8435195809916
64006	1 1/4" x 3/4"	10	8435195809923
64007	1 1/4" x 1"	10	8435195809930
64025	1 1/2" x 1/2"	10	8435195809947
64008	1 1/2" x 3/4"	10	8435195809954
64009	1 1/2" x 1"	10	8435195809961
64010	1 1/2" x 1 1/4"	10	8435195809978
64019	2" x 1/2"	10	8435195809985
64011	2" x 3/4"	10	8435195809992
64012	2" x 1"	10	8435195810004
64013	2" x 1 1/4"	10	8435195810011
64014	2" x 1 1/2"	10	8435195810028
64030	2 1/2" x 3/4"	1	8435195823165
64031	2 1/2" x 1"	1	8435195823172
64033	2 1/2" x 1 1/4"	1	8435195823189
64034	2 1/2" x 1 1/2"	1	8435195823196
64015	2 1/2" x 2"	5	8435195810035
64035	3" x 1 1/4"	1	8435195823202
64016	3" x 2"	5	8435195810042
64017	3" x 2 1/2"	5	8435195810059
64037	4 x 2"	1	8435195828269
64028	4" x 2 1/2"	1	8435195810066
64029	4" x 3"	1	8435195810073

REDUCCIÓN LISA M-H



Código	Medida	Caja	EAN
64020	3/8" x 1/4"	100	8435195810080
64021	1/2" x 3/8"	100	8435195810097
64042	7/8" x 3/4"	100	8435195841671
64022	3/4" x 1/2"	100	8435195810103
64041	1" x 1/2"	50	8435195841664
64023	1" x 3/4"	50	8435195810110

RACORERÍA DE LATÓN ROSCAR

CODO H-H (TH90)



Código	Medida	Caja	EAN
46001	1/4"	50	8435195847925
46002	3/8"	50	8435195804638
46003	1/2"	50	8435195804645
46004	3/4"	25	8435195804652
46005	1"	10	8435195804669
46006	1 1/4"	10	8435195804676
46007	1 1/2"	10	8435195804683
46008	2"	5	8435195804690
46009	2 1/2"	2	8435195804706
46010	3"	2	8435195804713
46011	4"	2	8435195804720

CODO CROMADO H-H (TH90)



Código	Medida	Caja	EAN
46012	3/8"	50	8435195804737
46013	1/2"	25	8435195804744
46014	3/4"	25	8435195804751
46015	1"	10	8435195804768

CODO REDUCIDO H-H (TH90/R)



Código	Medida	Caja	EAN
46032	3/8" x 1/2"	50	8435195804775
46033	1/2" x 3/4"	25	8435195804782
46034	3/4" x 1"	5	8435195804799
46035	1/2" x 1"	5	8435195804805

CODO REDUCIDO CROMADO H-H (TH90/R)



Código	Medida	Caja	EAN
46037	3/8" x 1/2"	50	8435195804812
46038	1/2" x 3/4"	25	8435195804829
46039	3/4" x 1"	10	8435195804836

RACORERÍA DE LATÓN ROSCAR

CODO M-H (TH92)



Código	Medida	Caja	EAN
47002	3/8"	50	8435195804867
47003	1/2"	50	8435195804874
47004	3/4"	25	8435195804881
47005	1"	10	8435195804898
47006	1 1/4"	10	8435195804904
47007	1 1/2"	10	8435195804911
47008	2"	5	8435195804928
47009	2 1/2"	2	8435195804935
47010	3"	2	8435195804942
47011	4"	2	8435195804959

CODO CROMADO M-H (TH92)



Código	Medida	Caja	EAN
47012	3/8"	50	8435195804966
47013	1/2"	25	8435195804973
47014	3/4"	25	8435195804980
47015	1"	10	8435195804997

CODO REDUCIDO M-H (TH92/R)



Código	Medida	Caja	EAN
47032	1/2" x 3/4"	25	8435195805000
47033	3/4" x 1"	10	8435195805017
47034	1" x 1 1/4"	5	8435195805024

CODO REDUCIDO CROMADO M-H (TH92/R)



Código	Medida	Caja	EAN
47037	1/2" x 3/4"	25	8435195805031
47038	3/4" x 1"	10	8435195805048
47039	1" x 1 1/4"	5	8435195805055

RACORERÍA DE LATÓN ROSCAR

TE H-H-H (TH130)



Código	Medida	Caja	EAN
45001	1/4"	10	8435195826968
45002	3/8"	50	8435195804492
45003	1/2"	50	8435195804508
45004	3/4"	25	8435195804515
45005	1"	10	8435195804522
45006	1 1/4"	5	8435195804539
45007	1 1/2"	5	8435195804546
45008	2"	5	8435195804553
45009	2 1/2"	2	8435195804560
45010	3"	2	8435195804577
45011	4"	2	8435195804584

TE CROMADA H-H-H (TH130)



Código	Medida	Caja	EAN
45012	3/8"	50	8435195804591
45013	1/2"	25	8435195804607
45014	3/4"	25	8435195804614
45015	1"	10	8435195804621

TE REDUCIDA H-H-H (TH130)



Código	Medida	Caja	EAN
45016	3/4" x 1/2" x 3/4"	1	8435195833133
45021	3/4" x 3/4" x 1/2"	1	8435195833140
45017	1" x 3/4" x 1"	1	8435195833157
45018	1" x 1/2" x 1"	1	8435195833164
45019	1 1/4" x 1/2" x 1 1/4"	1	8435195833171
45020	1 1/4" x 3/4" x 1 1/4"	1	8435195833188
45037	1 1/4" x 1" x 1 1/4"	1	8435195833195
45032	1 1/2" x 1/2" x 1 1/2"	1	8435195833201
45035	1 1/2" x 3/4" x 1 1/2"	1	8435195833218
45024	1 1/2" x 1" x 1 1/2"	1	8435195833225
45027	1/2" x 1 1/4" x 1 1/2"	1	8435195833232
45036	2" x 3/4" x 2"	1	8435195833249
45033	2" x 1 1/4" x 2"	1	8435195833256
45034	2" x 1 1/2" x 2"	1	8435195833263

RACORERÍA DE LATÓN ROSCAR

MANGUITO H-H (TH270)



Código	Medida	Caja	EAN
48001	1/4"	50	8435195838107
48002	3/8"	50	8435195805222
48003	1/2"	50	8435195805239
48004	3/4"	25	8435195805246
48005	1"	10	8435195805253
48006	1 1/4"	5	8435195805260
48007	1 1/2"	5	8435195805277
48008	2"	5	8435195805284
48009	2 1/2"	2	8435195805291
48010	3"	2	8435195805307
48011	4"	2	8435195805314

MANGUITO CROMADO H-H (TH270)



Código	Medida	Caja	EAN
48012	3/8"	50	8435195805321
48013	1/2"	50	8435195805338
48014	3/4"	25	8435195805345
48015	1"	10	8435195805352

MANGUITO REDUCIDO H-H (TH240)



Código	Medida	Caja	EAN
48017	3/8" x 1/2"	50	8435195805369
48018	1/2" x 3/4"	25	8435195805376
48065	1/2" x 1"	25	8435195838183
48019	3/4" x 1"	10	8435195805383
48020	1" x 1 1/4"	10	8435195805390
48024	1" x 2"	5	8435195805437
48021	1 1/4" x 1 1/2"	5	8435195805406
48023	1 1/4" x 2"	5	8435195805420
48022	1 1/2" x 2"	5	8435195805413
48025	2 1/2" x 2"	1	8435195826999
48029	3" x 2"	1	8435195838114

MANGUITO REDUCIDO CROMADO H-H (TH240)



Código	Medida	Caja	EAN
48027	1/2" x 3/4"	50	8435195805451
48028	3/4" x 1"	25	8435195805468

RACORERÍA DE LATÓN ROSCAR

TAPÓN HEMBRA (TH300)



Código	Medida	Caja	EAN
70000	1/8"	100	8435195811384
70001	1/4"	100	8435195811391
70002	3/8"	100	8435195811407
70003	1/2"	100	8435195811414
70004	3/4"	50	8435195811421
70005	1"	25	8435195811438
70006	1 1/4"	10	8435195811445
70007	1 1/2"	10	8435195811452
70008	2"	5	8435195811469
70009	2 1/2"	2	8435195811476
70010	3"	2	8435195811483
70011	4"	2	8435195811490

TAPÓN HEMBRA CROMADO (TH300)



Código	Medida	Caja	EAN
70019	1/2"	25	8435195827248
70020	3/4"	10	8435195827255
70021	1"	5	8435195827262

TAPÓN HEMBRA CON PRECINTO PARA GAS



Código	Medida	Caja	EAN
70014	1/2"	100	8435195800906
70015	3/4"	50	8435195827279
70016	1"	25	8435195827286
70017	7/8"	25	8435195827293

RACORERÍA DE LATÓN ROSCAR

TAPÓN MACHO (TH290)



Código	Medida	Caja	EAN
70500	1/8"	100	8435195811506
70501	1/4"	100	8435195811513
70502	3/8"	100	8435195811520
70503	1/2"	100	8435195811537
70504	3/4"	50	8435195811544
70505	1"	25	8435195811551
70506	1 1/4"	10	8435195811568
70507	1 1/2"	10	8435195811575
70508	2"	5	8435195811582
70509	2 1/2"	1	8435195811599
70510	3"	1	8435195811605
70511	4"	1	8435195811612

TAPÓN MACHO CROMADO (TH290)



Código	Medida	Caja	EAN
70512	3/8"	25	8435195827309
70513	1/2"	25	8435195827316
70514	3/4"	25	8435195827323
70520	1"	5	8435195827330

TAPÓN MACHO CON PRECINTO PARA GAS



Código	Medida	Caja	EAN
70515	1/2"	100	8435195828054
70516	3/4"	50	8435195828061
70518	1"	25	8435195828078
70519	7/8"	25	8435195828078

RACORERÍA DE LATÓN ROSCAR

UNIÓN 3 PIEZAS H-H CIERRE CÓNICO (TH340)



Código	Medida	Caja	EAN
69501	1/2"	10	8435195811032
69502	3/4"	10	8435195811049
69503	1"	5	8435195811056
69504	1 1/4"	5	8435195811063
69505	1 1/2"	2	8435195811070
69506	2"	2	8435195811087
69507	2 1/2"	1	8435195824339
69508	3"	1	8435195827347
69509	4"	1	8435195827354

UNIÓN 3 PIEZAS H-H CIERRE JUNTA PLANA



Código	Medida	Caja	EAN
69581	1/2"	10	8435195833270
69582	3/4"	10	8435195833287
69583	1"	5	8435195833294
69584	1 1/4"	2	8435195833300
69585	1 1/2"	2	8435195833317
69586	2"	1	8435195833324

UNIÓN 3 PIEZAS M-H CIERRE CÓNICO (TH341)



Código	Medida	Caja	EAN
69510	1/2"	10	8435195811094
69511	3/4"	10	8435195811100
69512	1"	5	8435195811117
69513	1 1/4"	5	8435195811124
69514	1 1/2"	2	8435195811131
69515	2"	2	8435195811148
69516	2 1/2"	1	8435195824346

UNIÓN 3 PIEZAS M-H CIERRE JUNTA PLANA



Código	Medida	Caja	EAN
69591	1/2"	10	8435195833331
69592	3/4"	10	8435195833348
69593	1"	5	8435195833355
69594	1 1/4"	5	8435195833362
69595	1 1/2"	2	8435195833379
69596	2"	2	8435195833386

RACORERÍA DE LATÓN ROSCAR

RACOR DEPÓSITO URALITA CON TUERCA CORREDERA



Código	Medida	Caja	
59402	3/8"	25	8435195808636
59403	1/2"	25	8435195808643
59404	3/4"	15	8435195808650
59405	1"	10	8435195808667
59406	1 1/4"	6	8435195808674
59407	1 1/2"	5	8435195808681
59408	2"	2	8435195808698
59409	2 1/2"	2	8435195808704
59410	3"	2	8435195808711

RACOR DEPÓSITO URALITA CON TUERCA CORREDERA Y TUBO



Código	Medida	Caja	EAN
59603	1/2"	25	8435195808728
59604	3/4"	25	8435195808735
59605	1"	10	8435195808742
59606	1 1/4"	6	8435195808759
59607	1 1/2"	4	8435195808766
59608	2"	2	8435195808773
59609	2 1/2"	2	8435195808780
59610	3"	2	8435195808797

ARANDELA DE ACERO CINCADO



Código	Medida	Caja	EAN
59615	3/8" x 38	100	8435195808803
59616	1/2" x 45	100	8435195808810
59617	3/4" x 55	100	8435195808827
59618	1" x 66	50	8435195808834
59619	1 1/4" x 66	50	8435195808841
59620	1 1/2" x 78	50	8435195808858
59621	2" x 88	50	8435195808865

ARANDELA DE LATÓN



Código	Medida	Caja	EAN
59625	1/2" x 45	100	8435195808889
59626	3/4" x 55	100	8435195808896
59627	1" x 66	50	8435195808902
59628	1 1/4" x 66	50	8435195808919
59629	1 1/2" x 78	50	8435195808926
59630	2" x 88	50	8435195808933

ARANDELA DE ACERO INOXIDABLE



Código	Medida	Caja	EAN
59634	3/8" x 38	100	8435195841213
59635	1/2" x 45	100	8435195841220
59636	3/4" x 55	100	8435195841237
59637	1" x 66	50	8435195847888
59638	1 1/4" x 66	50	8435195847895
59639	1 1/2" x 78	50	8435195847901
59640	2" x 88	50	8435195847918

RACORERÍA DE LATÓN ROSCAR

TUERCA CORREDERA CON VALONA



Código	Medida	Caja	EAN
69519	3/8"	100	8435195811155
69520	1/2"	100	8435195811162
69521	3/4"	100	8435195811179
69522	1"	50	8435195811186
69523	1 1/4"	25	8435195811193
69524	1 1/2"	25	8435195811209
69525	2"	25	8435195811216
69526	2 1/2"	10	8435195811223
69527	3"	10	8435195811230
99329	28/150	100	8435195847185

ALARGADERA CILÍNDRICA PULIDA M-H (TH526)



Código	Medida	Caja	EAN
58900	3/8" x 30 mm.	25	8435195825664
58901	3/8" x 50 mm.	50	8435195808452
58902	3/8" x 100 mm.	50	8435195808469

59001	1/2" x 10 mm.	50	8435195808476
59002	1/2" x 20 mm.	50	8435195808483
59003	1/2" x 30 mm.	50	8435195808490
59006	1/2" x 40 mm.	25	8435195825671
59004	1/2" x 50 mm.	25	8435195808506
59008	1/2" x 60 mm.	25	8435195825688
59009	1/2" x 70 mm.	25	8435195825695
59010	1/2" x 80 mm.	25	8435195825701
59005	1/2" x 100 mm.	10	8435195808513

59011	3/4" x 50 mm.	10	8435195808520
59012	3/4" x 100 mm.	5	8435195808537

ALARGADERA CILÍNDRICA CROMADA M-H (TH526)



Código	Medida	Caja	EAN
59100	3/8" x 30 mm.	25	8435195825718
59101	3/8" x 50 mm.	50	8435195808544
59102	3/8" x 100 mm.	50	8435195808551

59201	1/2" x 10 mm.	50	8435195808568
59202	1/2" x 20 mm.	50	8435195808575
59203	1/2" x 30 mm.	50	8435195808582
59206	1/2" x 40 mm.	25	8435195825725
59204	1/2" x 50 mm.	25	8435195808599
59208	1/2" x 60 mm.	25	8435195825732
59209	1/2" x 70 mm.	25	8435195825756
59210	1/2" x 80 mm.	25	8435195825763
59205	1/2" x 100 mm.	10	8435195808605

59211	3/4" x 50 mm.	10	8435195808612
59212	3/4" x 100 mm.	5	8435195808629

RACORERÍA DE LATÓN ROSCAR

CODO 3 BOCAS H (TH221)



Código	Medida	Caja	EAN
46016	1/2"	10	8435195804843
46017	3/4"	15	8435195804850

CRUZ 4 BOCAS H (TH180)



Código	Medida	Caja	EAN
48501	3/8"	10	8435195827002
48502	1/2"	10	8435195805741
48503	3/4"	10	8435195805758
48504	1"	5	8435195805765
48505	1 1/4"	2	8435195805772
48506	1 1/2"	2	8435195805789
48507	2"	2	8435195805796
48508	2 1/2"	1	8435195827019
48509	3"	1	8435195827026

RACOR TE 5 VÍAS



Código	Medida	Caja	EAN
47101	1" x 1" x 1" x 1/4" x 81 mm.	5	8435195805208
47102	1" x 1" x 1" x 1/4" x 92 mm.	5	8435195805215
47103	1" x 1" x 1" x 1/4" x 120 mm	5	8435195833836

BEBEDERO DE CERDO



Código	Medida	Caja	EAN
99354	1/2"	25	8435195811025

CURVA 90° M-H (TH1)



Código	Medida	Caja	EAN
47016	1/2"	10	8435195805062
47017	3/4"	10	8435195805079
47018	1"	5	8435195805086
47019	1 1/4"	3	8435195805093
47020	1 1/2"	3	8435195805109
47021	2"	2	8435195805116

CURVA 90° H-H (TH2)



Código	Medida	Caja	EAN
47022	1/2"	10	8435195805123
47023	3/4"	10	8435195805130
47024	1"	5	8435195805147
47025	1 1/4"	3	8435195805154
47026	1 1/2"	3	8435195805161
47027	2"	3	8435195805178
47028	2 1/2"	2	8435195805185
47029	3"	2	8435195805192

RACORERÍA DE LATÓN ROSCAR

COLLARÍN TOMA CON JUNTA



Código	Medida	Caja	EAN
48030	1/2" x 20	25	8435195805475
48031	1/2" x 25	25	8435195805482
48032	1/2" x 32	15	8435195805499
48033	1/2" x 40	10	8435195805505
48034	1/2" x 50	5	8435195805512
48035	1/2" x 63	5	8435195805529
48036	1/2" x 75	2	8435195805536
48037	1/2" x 90	2	8435195805543
48038	3/4" x 40	10	8435195805550
48039	3/4" x 50	5	8435195805567
48040	3/4" x 63	5	8435195805574
48041	3/4" x 75	2	8435195805581
48042	3/4" x 90	2	8435195805598
48043	1" x 63	2	8435195805604
48044	1" x 75	2	8435195805611
48045	1" x 90	2	8435195805628

COLLARÍN CIEGO CON JUNTA



Código	Medida	Caja	EAN
48050	1/2" x 20	25	8435195805635
48051	3/4" x 25	25	8435195805642
48052	1" x 32	15	8435195805659
48053	1 1/4" x 40	10	8435195805666
48054	1 1/2" x 50	5	8435195805673
48055	2" x 63	2	8435195805680
48056	2 1/2" x 75	2	8435195805697
48057	3" x 90	2	8435195805703

MANGUITO ELECTROLÍTICO Con fibra de vidrio



	Código	Medida	Caja	EAN
H-H	72503	1/2"	25	8435195812060
	72504	3/4"	25	8435195812077
	72505	1"	10	8435195812084
	72506	1 1/4"	8	8435195812091
	72507	1 1/2"	6	8435195812107
	72508	2"	4	8435195812114
	72509	2 1/2"	2	8435195812121
	72510	3"	2	8435195812138
	72514	4"	2	8435195812145







	Código	Medida	Caja	EAN
M-H	72602	1/2"	25	8435195826975
	72603	3/4"	25	8435195826982

MANGUITO ELECTROLÍTICO M-H



Código	Medida	Caja	EAN
72601	1/2"	25	8435195812152

RACORERÍA DE LATÓN SOLDAR

Codos		188
Enlaces y entronques		189
Te H		190
Tapones		190
Curva desviación		190
Cruz fundida		190

RACORERÍA DE LATÓN SOLDAR

CODO HEMBRA (90GCu)



Código	Medida	Caja	EAN
49007	3/8" x 15 Ø	25	8435195805802
49011	1/2" x 12 Ø	25	8435195805819
49001	1/2" x 15 Ø	25	8435195805826
49028	1/2" x 16 Ø	25	8435195838534
49003	1/2" x 18 Ø	25	8435195805833
49008	1/2" x 22 Ø	25	8435195805840
49009	3/4" x 15 Ø	25	8435195805857
49004	3/4" x 18 Ø	25	8435195805864
49005	3/4" x 22 Ø	25	8435195805871
49012	3/4" x 28 Ø	10	8435195821192
49010	1" x 22 Ø	10	8435195805888
49006	1" x 28 Ø	10	8435195805895
49013	1 1/4" x 28 Ø	5	8435195821208
49002	1 1/4" x 35 Ø	5	8435195821215
49014	1 1/2" x 42 Ø	5	8435195821222
49000	2" x 54 Ø	2	8435195821239

CODO MACHO (92GCu)



Código	Medida	Caja	EAN
49026	1/2" x 12 Ø	25	8435195838510
49015	1/2" x 15 Ø	25	8435195805901
49016	1/2" x 18 Ø	25	8435195805918
49017	1/2" x 22 Ø	25	8435195805925
49018	3/4" x 18 Ø	25	8435195805932
49019	3/4" x 22 Ø	25	8435195805949
49020	1" x 28 Ø	10	8435195805956

CODO MURAL (472GCu)



Código	Medida	Caja	EAN
49035	1/2" x 12 Ø	25	8435195805963
49031	1/2" x 15 Ø	25	8435195805970
49032	1/2" x 18 Ø	25	8435195805987
49037	3/4" x 18 Ø	25	8435195838558
49033	3/4" x 22 Ø	25	8435195805994
49034	1" x 28 Ø	10	8435195806007

RACORERÍA DE LATÓN SOLDAR

ENLACE HEMBRA (270Gcu)



Código	Medida	Caja	EAN
49085	3/8" x 12 Ø	25	8435195806281
49079	3/8" x 15 Ø	25	8435195806298
49077	1/2" x 10 Ø	25	8435195806304
49078	1/2" x 12 Ø	25	8435195806311
49071	1/2" x 15 Ø	25	8435195806328
49072	1/2" x 18 Ø	25	8435195806335
49073	1/2" x 22 Ø	25	8435195806342
49080	3/4" x 15 Ø	25	8435195806359
49074	3/4" x 18 Ø	25	8435195806366
49075	3/4" x 22 Ø	25	8435195806373
49084	3/4" x 28 Ø	10	8435195806380
49082	1" x 22 Ø	10	8435195806397
49076	1" x 28 Ø	10	8435195806403
49081	1 1/4" x 28 Ø	5	8435195806410
49083	1 1/4" x 35 Ø	5	8435195806427
49088	1 1/2" x 42 Ø	5	8435195806434
49022	1 1/2" x 54 Ø	5	8435195823219
49087	2" x 54 Ø	2	8435195806441

ENTRONQUE MACHO (243Gcu)



Código	Medida	Caja	EAN
49052	3/8" x 10 Ø	25	8435195806090
49068	3/8" x 12 Ø	25	8435195806106
49027	3/8" x 14 Ø	25	8435195838527
49036	3/8" x 15 Ø	25	8435195806113
49061	1/2" x 12 Ø	25	8435195806120
49024	1/2" x 14 Ø	25	8435195838503
49055	1/2" x 15 Ø	25	8435195806137
49056	1/2" x 18 Ø	25	8435195806144
49057	1/2" x 22 Ø	25	8435195806151
49062	3/4" x 15 Ø	25	8435195806168
49058	3/4" x 18 Ø	25	8435195806175
49059	3/4" x 22 Ø	25	8435195806182
49067	3/4" x 28 Ø	25	8435195806199
49064	1" x 22 Ø	10	8435195806205
49060	1" x 28 Ø	10	8435195806212
49039	1" x 35 Ø	10	8435195838572
49063	1 1/4" x 28 Ø	5	8435195806229
49065	1 1/4" x 35 Ø	5	8435195806236
49070	1 1/4" x 42 Ø	5	8435195806243
49054	1 1/2" x 35 Ø	5	8435195821284
49066	1 1/2" x 42 Ø	5	8435195806250
49086	2" x 54 Ø	2	8435195806267
49069	2 1/2" x 64 Ø	2	8435195806274
49089	3" x 76 Ø	1	8435195821291

RACORERÍA DE LATÓN SOLDAR

TE HEMBRA (130GCu)



Código	Medida	Caja	EAN
49090	3/8" x 12 Ø	25	8435195838602
49040	3/8" x 15 Ø	25	8435195838589
49047	1/2" x 12 Ø	25	8435195806014
49041	1/2" x 15 Ø	25	8435195806021
49042	1/2" x 18 Ø	25	8435195806038
49043	1/2" x 22 Ø	25	8435195806045
49044	3/4" x 18 Ø	25	8435195806052
49045	3/4" x 22 Ø	25	8435195806069
49048	3/4" x 28 Ø	10	8435195806076
49049	1" x 22 Ø	10	8435195821246
49046	1" x 28 Ø	10	8435195806083
49025	1 1/4" x 35 Ø	5	8435195821253
49050	1 1/2" x 42 Ø	5	8435195821260
49051	2" x 54 Ø	2	8435195821277

TAPÓN LATÓN (310GCu)



Código	Medida	Caja	EAN
49091	12 Ø	25	8435195806458
49092	15 Ø	25	8435195806465
49093	18 Ø	25	8435195806472
49094	22 Ø	25	8435195806489

CURVA DESVIACIÓN (85GCu)



Código	Medida	Caja	EAN
99360	15 x 15 Ø	10	8435195806496
99707	18 x 18 Ø	10	8435195806502
98051	22 x 22 Ø	10	8435195806519

CRUZ FUNDIDA (180GCU)



Código	Medida	Caja	EAN
49122	22 x 22 Ø	10	8435195838657
49123	28 x 28 Ø	10	8435195838664
49124	35 x 35 Ø	10	8435195838671

RACORERÍA DE LATÓN PARA RIEGO

Lanza manguera 3 efectos		192
Entronques, manguitos y te manguera		192
Racor manguera 2 piezas		193
Colzadas riego y juntas		193
Válvula esfera riego		193
Racor rápido "Barcelona" y juntas		194
Te M, Te H, Te lisa		195
Boquillas		195

RACORERÍA DE LATÓN PARA RIEGO

LANZA MANGUERA 3 EFECTOS



Código	Medida	Caja	EAN
99122	16 mm. Ø	1	8435195822922
99123	20 mm. Ø	1	8435195822939
99124	25 mm. Ø	1	8435195822946

ENTRONQUE MANGUERA MACHO



Código	Medida	Caja	EAN
69530	3/8" x 13 mm.	25	8435195811247
69531	1/2" x 17 mm.	25	8435195811254
69532	3/4" x 22 mm.	25	8435195811261
69533	1" x 29 mm.	10	8435195811278
69534	1 1/4" x 34 mm.	5	8435195811285
69535	1 1/2" x 43 mm.	5	8435195811292
69536	2" x 55 mm.	1	8435195811308
69536A	2" x 85 mm.	1	8435195848113
69560	2 1/2" x 56 mm.	1	8435195827408
69537	3" x 75 mm.	1	8435195811315
69561	4" x 102 mm.	1	8435195827415

ENTRONQUE MANGUERA MACHO REFORZADO



Código	Medida	Caja	EAN
69562	1" x 27 mm.	10	8435195842067
69554	1 1/4" x 38 mm.	5	8435195842036
69555	1 1/2" x 43 mm.	5	8435195842043
69563	2" x 50 mm.	1	8435195842074
69556	2" x 57 mm.	1	8435195842050

MANGUITO EMPALME MANGUERA



Código	Medida	Caja	EAN
99111	3/8"	10	8435195817119
99112	1/2"	10	8435195817126
99113	3/4"	10	8435195817133
99114	1"	10	8435195817140
99115	1 1/4"	10	8435195817157

TE EMPALME MANGUERA



Código	Medida	Caja	EAN
99118	3/8"	10	8435195817164
99119	1/2"	10	8435195817171
99120	3/4"	10	8435195817188
99121	1"	10	8435195817195

RACORERÍA DE LATÓN PARA RIEGO

RACOR MANGUERA 2 PIEZAS



Código	Medida	Caja	EAN
69801	3/8"	25	8435195821413
69802	1/2"	25	8435195811322
69803	3/4"	25	8435195811339
69804	1"	5	8435195811346
69805	1 1/4"	5	8435195811353
69806	1 1/2"	2	8435195811360
69807	2"	2	8435195811377

COLZADA RIEGO TIPO "MADRID"



Código	Descripción	Caja	EAN
48092	Curva	10	8435195805727

Código	Descripción	Caja	EAN
48091	Recta	10	8435195805710

JUNTA COLZADA RIEGO



Código	Medida	Caja	EAN
48093	Única	10	8435195805734

VÁLVULA ESFERA RIEGO



Código	Medida	Caja	EAN
990111	M 1/2" x H 3/8"	100	8435195817102

RACORERÍA DE LATÓN PARA RIEGO

RACOR RÁPIDO MACHO "BARCELONA"



Código	Medida	Caja	EAN
69621	M 1/2" x M 1/2"	10	8435195823103
69622	M 3/4" x M 3/4"	10	8435195823110
69623	M 1" x M 1"	5	8435195823127
69624	M 1 1/4" x M 1 1/4"	5	8435195823134
69625	M 1 1/2" x M 1 1/2"	2	8435195823141
69626	M 2" x M 2"	2	8435195823158

RACOR RÁPIDO MANGUERA "BARCELONA"



Código	Medida	Caja	EAN
69611	20 x 20 Ø	10	8435195823011
69612	25 x 25 Ø	10	8435195823028
69613	32 x 32 Ø	5	8435195823035
69614	35 x 35 Ø	5	8435195823042
69615	40 x 40 Ø	2	8435195823059
69616	45 x 45 Ø	2	8435195823066
69617	50 x 50 Ø	2	8435195823073
69618	60 x 60 Ø	2	8435195823080
69619	70 x 70 Ø	1	8435195823097

RACOR RÁPIDO MACHO-MANGUERA "BARCELONA"



Código	Medida	Caja	EAN
69601	1/2" x 20 Ø	10	8435195822953
69602	3/4" x 25 Ø	10	8435195822960
69603	1" x 30 Ø	5	8435195822977
69604	1 1/4" x 35 Ø	5	8435195822984
69605	1 1/2" x 45 Ø	2	8435195822991
69606	2" x 60 Ø	2	8435195823004

JUNTA CAUCHO RACOR "BARCELONA"



Código	Medida	Caja	EAN
69631	20 mm.	25	8435195825053
69632	25 mm.	25	8435195825060
69633	30 mm.	25	8435195825077
69634	35 mm.	10	8435195825084
69635	40 mm.	10	8435195825091
69636	45 mm.	10	8435195825107
69637	50 mm.	5	8435195825114
69638	60 mm.	5	8435195825121
69639	70 mm.	5	8435195825138

RACORERÍA DE LATÓN PARA RIEGO

TE MACHO



Código	Medida	Caja	EAN
990100	3/8" x 10 mm.	25	8435195816990

TE HEMBRA



Código	Medida	Caja	EAN
990101	1/4" x 10 mm.	10	8435195817164

BOQUILLA MACHO



Código	Medida	Caja	EAN
990103	1/4"	50	8435195817027
990104	3/8"	50	8435195817034
990105	1/2"	50	8435195817041

BOQUILLA LISA



Código	Medida	Caja	EAN
990106	8 mm. Ø	50	8435195817058
990107	10 mm. Ø	50	8435195817065

BOQUILLA RACOR LOCO



Código	Medida	Caja	EAN
990108	8 mm. Ø	50	8435195817072
990109	10 mm. Ø	50	8435195817089

TUERCA RACOR LOCO



Código	Medida	Caja	EAN
990110	1/2"	50	8435195817096



NIPPELS GALVANIZADOS

Nippels galvanizados



198



NIPPELS GALVANIZADOS



ROSCA EN AMBOS EXTREMOS

ROSCA CÓNICA ISO 7/1 (EN 10226-1) DIN 2982 (EN 10241)

NIPPEL GALVANIZADO 1/4"

1/4"

Código	Medida	Caja	EAN
80101	1/4" x 40 mm.	10	8435195812787
80102	1/4" x 60 mm.	10	8435195812794
80103	1/4" x 80 mm.	10	8435195812800
80104	1/4" x 100 mm.	10	8435195812817

NIPPEL GALVANIZADO 3/8"

3/8"

Código	Medida	Caja	EAN
99030	3/8" x 40 mm.	10	8435195812824
80020	3/8" x 60 mm.	10	8435195812831
98031	3/8" x 80 mm.	10	8435195812848
82021	3/8" x 100 mm.	10	8435195812855
98025	3/8" x 120 mm.	10	8435195812862
82022	3/8" x 160 mm.	10	8435195812879
82024	3/8" x 200 mm.	10	8435195812886
82029	3/8" x 300 mm.	10	8435195812893
98026	3/8" x 500 mm.	10	8435195812909

NIPPEL GALVANIZADO 1/2"

1/2"

Código	Medida	Caja	EAN
80001	1/2" x 40 mm.	10	8435195812916
80002	1/2" x 60 mm.	10	8435195812923
80003	1/2" x 80 mm.	10	8435195812930
80004	1/2" x 100 mm.	10	8435195812947
80005	1/2" x 120 mm.	10	8435195812954
80006	1/2" x 140 mm.	10	8435195812961
80007	1/2" x 160 mm.	10	8435195812978
80008	1/2" x 180 mm.	10	8435195812985
80009	1/2" x 200 mm.	10	8435195812992
80010	1/2" x 250 mm.	10	8435195813005
80011	1/2" x 300 mm.	10	8435195813012
80016	1/2" x 400 mm.	10	8435195813029
80012	1/2" x 500 mm.	10	8435195813036
80017	1/2" x 600 mm.	10	8435195822175
80013	1/2" x 1000 mm.	10	8435195822182

Nota: Se puede fabricar cualquier medida de su interés bajo pedido

NIPPELS GALVANIZADOS

NIPPEL GALVANIZADO 3/4"

3/4"

Código	Medida	Caja	EAN
80501	3/4" x 40 mm.	10	8435195813043
80502	3/4" x 60 mm.	10	8435195813050
80503	3/4" x 80 mm.	10	8435195813067
80504	3/4" x 100 mm.	10	8435195813074
80505	3/4" x 120 mm.	10	8435195813081
80506	3/4" x 140 mm.	10	8435195813098
80507	3/4" x 160 mm.	10	8435195813104
80508	3/4" x 180 mm.	10	8435195813111
80509	3/4" x 200 mm.	10	8435195813128
80510	3/4" x 250 mm.	10	8435195813135
80511	3/4" x 300 mm.	10	8435195813142
80515	3/4" x 400 mm.	10	8435195813159
80516	3/4" x 500 mm.	10	8435195813166

NIPPEL GALVANIZADO 1"

1"

Código	Medida	Caja	EAN
81001	1" x 40 mm.	10	8435195813173
81002	1" x 60 mm.	10	8435195813180
81003	1" x 80 mm.	10	8435195813197
81004	1" x 100 mm.	10	8435195813203
81005	1" x 120 mm.	10	8435195813210
81006	1" x 140 mm.	10	8435195813227
81007	1" x 160 mm.	10	8435195813234
81008	1" x 180 mm.	10	8435195813241
81009	1" x 200 mm.	10	8435195813258
81010	1" x 250 mm.	10	8435195813265
81011	1" x 300 mm.	10	8435195813272
81014	1" x 400 mm.	10	8435195813289
81013	1" x 500 mm.	10	8435195813296

NIPPEL GALVANIZADO 1 1/4"

1 1/4"

Código	Medida	Caja	EAN
81501	1 1/4" x 60 mm.	10	8435195813302
81502	1 1/4" x 80 mm.	10	8435195813319
81503	1 1/4" x 100 mm.	10	8435195813326
81504	1 1/4" x 120 mm.	10	8435195813333
81505	1 1/4" x 140 mm.	10	8435195813340
81506	1 1/4" x 160 mm.	10	8435195813357
81507	1 1/4" x 180 mm.	10	8435195813364
81508	1 1/4" x 200 mm.	10	8435195813371
81509	1 1/4" x 250 mm.	10	8435195813388
81510	1 1/4" x 300 mm.	10	8435195813395
81514	1 1/4" x 400 mm.	10	8435195813401
81512	1 1/4" x 500 mm.	10	8435195813418

Nota: Se puede fabricar cualquier medida de su interés bajo pedido



NIPPELS GALVANIZADOS

NIPPEL GALVANIZADO 1 1/2"

1 1/2"

Código	Medida	Caja	EAN
82001	1 1/2" x 60 mm.	10	8435195813425
82002	1 1/2" x 80 mm.	10	8435195813432
82003	1 1/2" x 100 mm.	10	8435195813449
82004	1 1/2" x 120 mm.	10	8435195813456
82005	1 1/2" x 140 mm.	10	8435195813463
82006	1 1/2" x 160 mm.	10	8435195813470
82007	1 1/2" x 180 mm.	10	8435195813487
82008	1 1/2" x 200 mm.	10	8435195813494
82009	1 1/2" x 250 mm.	10	8435195813500
82010	1 1/2" x 300 mm.	10	8435195813517
82013	1 1/2" x 400 mm.	10	8435195813524
82012	1 1/2" x 500 mm.	10	8435195813531

NIPPEL GALVANIZADO 2"

2"

Código	Medida	Caja	EAN
82501	2" x 60 mm.	10	8435195813548
82502	2" x 80 mm.	10	8435195813555
82503	2" x 100 mm.	10	8435195813562
82504	2" x 120 mm.	10	8435195813579
82505	2" x 140 mm.	10	8435195813586
82506	2" x 160 mm.	10	8435195813609
82507	2" x 180 mm.	10	8435195813616
82508	2" x 200 mm.	10	8435195813623
82509	2" x 250 mm.	10	8435195813630
82510	2" x 300 mm.	10	8435195813647
82513	2" x 400 mm.	10	8435195813654
82511	2" x 500 mm.	10	8435195813661

NIPPEL GALVANIZADO 2 1/2"

2 1/2"

Código	Medida	Caja	EAN
82520	2 1/2" x 100 mm.	10	8435195813678
82521	2 1/2" x 120 mm.	10	8435195813685
82522	2 1/2" x 160 mm.	10	8435195813692
82523	2 1/2" x 200 mm.	10	8435195813708
82524	2 1/2" x 300 mm.	10	8435195813715
82525	2 1/2" x 500 mm.	10	8435195813722





NIPPEL GALVANIZADO 3"

3"

Código	Medida	Caja	EAN
82530	3" x 100 mm.	10	8435195813739
82531	3" x 120 mm.	10	8435195813746
82532	3" x 160 mm.	10	8435195813753
82533	3" x 200 mm.	10	8435195813760
82534	3" x 300 mm.	10	8435195813777
82535	3" x 500 mm.	10	8435195813784

Nota: Se puede fabricar cualquier medida de su interés bajo pedido

VÁLVULAS DE FUNDICIÓN

Racores Unión		202
Abrazaderas de reparación		203
Conexiones manguera		204
Manguitos antivibratorios		204



VÁLVULAS DE FUNDICIÓN

Hierro galvanizado

RACOR UNIÓN MACHO A TUBO fundición maleable



Código	Medida	Caja	EAN
82901	M 1/2" x 21,3 mm.	5	8435195827576
82902	M 3/4" x 26,9 mm.	5	8435195827583
82903	M 1" x 33,7 mm.	5	8435195827590
82904	M 1 1/4" x 42,4 mm.	1	8435195833867
82905	M 1 1/2" x 48,3 mm.	1	8435195833874
82906	M 2" x 60,3 mm.	1	8435195833881
82907	M 2 1/2" x 76,1 mm.	1	8435195843859

RACOR UNIÓN HEMBRA A TUBO fundición maleable



Código	Medida	Caja	EAN
82915	H 1/2" x 21,3 mm.	5	8435195827606
82916	H 3/4" x 26,9 mm.	5	8435195827613
82917	H 1" x 33,7 mm.	5	8435195827620
82918	H 1 1/4" x 42,4 mm.	1	8435195833898
82919	H 1 1/2" x 48,3 mm.	1	8435195833904
82920	H 2" x 60,3 mm.	1	8435195833911

RACOR UNIÓN TUBO A TUBO fundición maleable



Código	Medida	Caja	EAN
82925	3/8" x 17,2 mm.	5	8435195843873
82926	1/2" x 21,3 mm.	5	8435195827637
82927	3/4" x 26,9 mm.	5	8435195827644
82928	1" x 33,7 mm.	5	8435195827651
82929	1 1/4" x 42,4 mm.	1	8435195833928
82930	1 1/2" x 48,3 mm.	1	8435195833935
82931	2" x 60,3 mm.	1	8435195833942

VÁLVULAS DE FUNDICIÓN

Hierro galvanizado

ABRAZADERA REPARACIÓN CORTA fundición maleable



Código	Medida	Caja	EAN
82971	1/2"	5	8435195827668
82972	3/4"	5	8435195827675
82973	1"	5	8435195827682
82974	1 1/4"	5	8435195827699
82975	1 1/2"	5	8435195827705
82976	2"	5	8435195827712
82978	3"	5	8435195843880

- Abrazaderas de fundición maleable para tubos de PE.
- Impermeabilización y reparación de fisuras y poros en tuberías de PE, PVC y otras.

ABRAZADERA REPARACIÓN LARGA fundición maleable



Código	Medida	Caja	EAN
82981	1/2"	5	8435195843897
82982	3/4"	5	8435195843903
82983	1"	5	8435195843910

- Abrazaderas de fundición maleable para tubos de PE.
- Impermeabilización y reparación de fisuras y poros en tuberías de PE, PVC y otras.

ABRAZADERA REPARACIÓN TAPAPOROS COBRE



Código	Medida	Caja	EAN
83124	15 mm.	5	8435195827729
83126	18 mm.	5	8435195827736
83127	22 mm.	5	8435195827743
83128	28 mm.	5	8435195827750

- Abrazaderas de unión para tubo de cobre.
- Tapaporos y derivaciones en latón.

ABRAZADERA REPARACIÓN TAPAPOROS CON TOMA COBRE



Código	Medida	Caja	EAN
83141	1/2" x 18 mm.	5	8435195844436
83142	1/2" x 22 mm.	5	8435195844443
83143	3/4" x 28 mm.	5	8435195844450

- Abrazaderas de unión para tubo de cobre.
- Tapaporos y derivaciones en latón.



VÁLVULAS DE FUNDICIÓN

Hierro galvanizado

CONEXIÓN MANGUERA



Código	Medida	Caja	EAN
82801	3/8" x 100 mm.	10	8435195822755
82802	1/2" x 100 mm.	10	8435195822762
82803	3/4" x 100 mm.	10	8435195822779
82804	1" x 100 mm.	10	8435195822786
82805	1 1/4" x 100 mm.	5	8435195822793
82806	1 1/2" x 100 mm.	5	8435195822809
82807	2" x 100 mm.	2	8435195822816
82808	2 1/2" x 100 mm.	1	8435195822823
82809	3" x 100 mm.	1	8435195822830

MANGUITO ANTIVIBRATORIO DOBLE ONDA



Código	Medida	Caja	EAN
82562	3/4"	1	8435195825213
82563	1"	1	8435195825220
82564	1 1/4"	1	8435195825237
82565	1 1/2"	1	8435195825244
82566	2"	1	8435195825251
82567	2 1/2"	1	8435195827521
82568	3"	1	8435195827538

CALEFACCIÓN

Purgadores automáticos		206
Purgadores manuales		207
Válvulas de seguridad y retención		207
Válvulas y detentores manuales para radiador		208
Válvulas termostaticables para radiador		210
Colectores		211
Tuercas		212
Florones y tapones		213
Termostatos y cronotermostatos		214
Soportes y complementos		215

CALEFACCIÓN

Purgadores automáticos de aire

PURGADOR AUTOMÁTICO DE AIRE salida superior



Código	Medida	Caja	EAN
90040	3/8"	20	8435195816808
90041	1/2"	20	8435195816815

PURGADOR AUTOMÁTICO DE AIRE salida lateral



Código	Medida	Caja	EAN
90045	3/8"	10	8435195816822
90046	1/2"	10	8435195816839

PURGADOR AUTOMÁTICO DE AIRE toma lateral



Código	Medida	Caja	EAN
90049	3/8"	10	8435195816846
90050	1/2"	10	8435195816853

VÁLVULA RETENCIÓN PARA PURGADOR AUTOMÁTICO



Código	Medida	Caja	EAN
90053	3/8"	20	8435195816860
90054	1/2"	20	8435195816877

CARACTERÍSTICAS TÉCNICAS

- Cuerpo y tapa de latón UNI EN 12165.
- Flotador: PP.
- Vástago del obturador de latón UNI EN 12165.
- Muelle: acero inoxidable.
- EPDM.
- Uso para fluidos de agua y solución de glicol.
- Máximo porcentaje de glicol: 30%.
- Presión máxima de trabajo: 10 bar.
- Presión máxima de descarga: de 2,5 a 4 bar.
- Temperatura máxima de trabajo: 110°C - 120°C.

CALEFACCIÓN

PURGADOR MANUAL DE AIRE PARA RADIADOR



Código	Medida	Caja	EAN
90057	1/8"	20	8435195816884
90058	1/4"	20	8435195816891
90059	3/8"	20	8435195816907
90060	1/2"	20	8435195816914

PURGADOR AUTOMÁTICO DE AIRE PARA RADIADOR



	Código	Medida	Caja	EAN
Izquierda	90070	1"	10	8435195816921
	90071	1 1/4"	10	8435195816938
Derecha	90072	1"	10	8435195816945
	90073	1 1/4"	10	8435195816952

VÁLVULA DE SEGURIDAD SIN SISTEMA DE RETENCIÓN



Código	Medida	Caja	EAN
90074	1/2"	50	8435195845174

VÁLVULA DE SEGURIDAD Y RETENCIÓN PARA TERMO



	Código	Medida	Caja	EAN
Sin palanca	90075	3/8"	50	8435195816969
	99506	1/2"	50	8435195815344
	90077	3/4"	50	8435195816983



	Código	Medida	Caja	EAN
Con palanca	90076	1/2" 8 Bares	50	8435195816976
	90079	1/2" 10 Bares	50	8435195827545
	90078	3/4" 8 Bares	50	8435195822748
	90098	3/4" 10 Bares	50	8435195845181

- Cuerpo de latón UNI EN 12165 cromado.
- Muelle: acero inoxidable 316,
- Rosca M/H.

DISPOSITIVO ANTIGOTEO PARA VÁLVULA DE SEGURIDAD



Código	Medida	Caja	EAN
90065	1/2"	10	8435195828177



CALEFACCIÓN

Válvulas y detentores manuales para radiador

VÁLVULA ESCUADRA M-M

	Código	Medida	Caja	EAN
Sin juntas	90080	3/8"	25	8435195823967
	90081	1/2"	25	8435195823974

	Código	Medida	Caja	EAN
Con juntas	90082	3/8"	25	8435195823981
	90083	1/2"	25	8435195823998



- Regulación manual.
- Cuerpo y tuerca en latón UNI EN 12165 niquelado.
- Obturador y racor en latón UNI EN 12164.
- Junta de estanqueidad obturador en EPDM.
- Volante en ABS blanco.
- Junta de estanqueidad racor en NBR.
- Presión máxima de ejercicio: 10 bar. / Presión diferencial máxima: 6 bar.

DETENTOR VÁLVULA ESCUADRA M-M

	Código	Medida	Caja	EAN
Sin juntas	90084	3/8"	25	8435195824001
	90085	1/2"	25	8435195824018

	Código	Medida	Caja	EAN
Con juntas	90086	3/8"	25	8435195824025
	90087	1/2"	25	8435195824032



- Regulación manual.
- Cuerpo y tuerca en latón UNI EN 12165 niquelado.
- Obturador, racor y anillo en latón UNI EN 12164.
- Junta de estanqueidad obturador en EPDM.
- Junta superior de estanqueidad obturador en EPDM.
- Capucha en ABS blanco.
- Junta de estanqueidad racor en NBR.
- Presión máxima de ejercicio: 10 bar. / Presión diferencial máxima: 6 bar.

CALEFACCIÓN

Válvulas y detentores manuales para radiador

VÁLVULA ESCUADRA M-H

	Código	Medida	Caja	EAN
Sin juntas	90088	3/8"	25	8435195824049
	90089	1/2"	25	8435195824056

	Código	Medida	Caja	EAN
Con juntas	90090	3/8"	25	8435195824063
	90093	1/2"	25	8435195824070



- Regulación manual.
- Cuerpo y tuerca en latón UNI EN 12165 niquelado.
- Obturador y racor en latón UNI EN 12164.
- Junta de estanqueidad obturador en EPDM.
- Volante en ABS blanco.
- Junta de estanqueidad racor en NBR.
- Presión máxima de ejercicio: 10 bar. / Presión diferencial máxima: 6 bar.

DETENTOR VÁLVULA ESCUADRA M-H

	Código	Medida	Caja	EAN
Sin juntas	90094	3/8"	25	8435195824087
	90095	1/2"	25	8435195824094

	Código	Medida	Caja	EAN
Con juntas	90096	3/8"	25	8435195824100
	90097	1/2"	25	8435195824117



- Regulación manual.
- Cuerpo y tuerca en latón UNI EN 12165 niquelado.
- Obturador, racor y anillo en latón UNI EN 12164.
- Junta de estanqueidad obturador en EPDM.
- Junta superior de estanqueidad obturador en EPDM.
- Capucha en ABS blanco.
- Junta de estanqueidad racor en NBR.
- Presión máxima de ejercicio: 10 bar. / Presión diferencial máxima: 6 bar.



CALEFACCIÓN

Válvulas termostaticables para radiador

VÁLVULA ESCUADRA M-M TERMOSTATIZABLE

	Código	Medida	Caja	EAN
Sin juntas	90100	3/8"	25	8435195824452
	90101	1/2"	25	8435195824469

	Código	Medida	Caja	EAN
Con juntas	90102	3/8"	25	8435195824476
	90103	1/2"	25	8435195824483



- Cuerpo y tuerca en latón UNI EN 12165 niquelado.
- Casquillo en PA6 (30% FV)
- Obturador, casquillo y arandela bloqueo de estanqueidad latón UNI EN 12164.
- Junta de estanqueidad cuerpo obturador en NBR.
- Muelle en acero AISI 302.
- Eje en acero AISI 304.
- Junta de estanqueidad obturador en EPDM.
- Juntas obturador en NBR.
- Volante en ABS blanco.
- Tuerca y racor en latón UNI EN 12165 niquelado.
- Junta de estanqueidad racor en NBR.
- Presión máxima de ejercicio: 10 bar. / Presión diferencial máxima: 6 bar.
- Adaptable a cabezales termostáticos Sensor o cabezales termoelectricos.

VÁLVULA ESCUADRA M-H TERMOSTATIZABLE

	Código	Medida	Caja	EAN
Sin juntas	90108	3/8"	25	8435195824490
	90109	1/2"	25	8435195824506

	Código	Medida	Caja	EAN
Con juntas	90110	3/8"	25	8435195824513
	90111	1/2"	25	8435195824520



- Cuerpo y tuerca en latón UNI EN 12165 niquelado.
- Casquillo en PA6 (30% FV)
- Obturador, casquillo y arandela bloqueo de estanqueidad latón UNI EN 12164.
- Junta de estanqueidad cuerpo obturador en NBR.
- Muelle en acero AISI 302.
- Eje en acero AISI 304.
- Junta de estanqueidad obturador en EPDM.
- Juntas obturador en NBR.
- Volante en ABS blanco.
- Tuerca y racor en latón UNI EN 12165 niquelado.
- Junta de estanqueidad racor en NBR.
- Presión máxima de ejercicio: 10 bar. / Presión diferencial máxima: 6 bar.
- Adaptable a cabezales termostáticos Sensor o cabezales termoelectricos.

CALEFACCIÓN

Colectores

COLECTOR CON VÁLVULA M-H



Código	Medida	Caja	EAN
90001	3/4" - 2 Vías	5	8435195823769
90003	3/4" - 3 Vías	5	8435195823776
90005	3/4" - 4 Vías	5	8435195823783

Código	Medida	Caja	EAN
90002	1" - 2 Vías	5	8435195823790
90004	1" - 3 Vías	5	8435195823806
90006	1" - 4 Vías	5	8435195823813

- Cuerpo en latón UNI EN 12165 niquelado.
- Conexiones roscadas 24 x 19
- Volante en ABS blanco.
- Juntas NBR.
- Presión máxima de ejercicio: 10 bar.
- Temperatura máx. +110°C.

COLECTOR M-H



Código	Medida	Caja	EAN
90011	3/4" - 2 Vías	5	8435195823820
90013	3/4" - 3 Vías	5	8435195823837
90015	3/4" - 4 Vías	5	8435195823844

Código	Medida	Caja	EAN
90012	1" - 2 Vías	5	8435195823851
90014	1" - 3 Vías	5	8435195823868
90016	1" - 4 Vías	5	8435195823875

- Cuerpo en latón UNI EN 12165 niquelado.
- Junta entre los elementos NBR 70.
- Derivaciones roscas 24 x 19 con paso de Ø 14 mm.
- Presión máxima de ejercicio: 10 bar.
- Temperatura máx. de 0°C a +110°C.

COLECTOR H-H



Código	Medida	Caja	EAN
90226	1" x 1/2" x 114 - 2 Vías	5	8435195824889
90228	1" x 1/2" x 214 - 4 Vías	5	8435195824896
90229	1" x 1/2" x 264 - 5 Vías	5	8435195824902
90230	1" x 1/2" x 314 - 6 Vías	5	8435195824919
90232	1" x 1/2" x 414 - 8 Vías	5	8435195824926
90234	1" x 1/2" x 514 - 10 Vías	5	8435195824933

90237	1 1/4" x 1/2" x 220 - 4 Vías	5	8435195824940
90239	1 1/4" x 1/2" x 320 - 6 Vías	5	8435195824957
90242	1 1/4" x 1/2" x 470 - 9 Vías	5	8435195824964
90243	1 1/4" x 1/2" x 520 - 10 Vías	5	8435195824971
90245	1 1/4" x 1/2" x 620 - 12 Vías	5	8435195824988

90252	1 1/2" x 1" x 370 - 4 Vías	1	8435195833409
90253	1 1/2" x 1" x 570 - 6 Vías	1	8435495833416

CALEFACCIÓN

Tuercas

TUERCA MONOBLOC 24x19 PARA TUBO DE COBRE



Código	Medida	Caja	EAN
90140	12 Ø	50	8435195824209
90141	14 Ø	50	8435195824216
90142	15 Ø	50	8435195824223
90143	16 Ø	50	8435195824230

- Presión máxima: 10 Bar.
- Temperatura máxima: 100°C.

TUERCA MONOBLOC 24x19 CON BICONO PARA TUBO DE COBRE



Código	Medida	Caja	EAN
90146	18 Ø	40	8435195824247

- Presión máxima: 10 Bar.
- Temperatura máxima: 100°C.

TUERCA MONOBLOC 24x19 PARA TUBO MULTICAPA



Código	Medida	Caja	EAN
90150	16 x 2	50	8435195824254
90151	16 x 2,25	50	8435195824261
90152	20 x 2	50	8435195824278
90153	20 x 2,50	40	8435195824285
90154	25 x 2,50	20	8435195824292

- Presión máxima: 10 Bar.
- Temperatura máxima: 100°C.

TUERCA MONOBLOC 24x19 PARA PEX - POLIPROPILENO - POLIBUTILENO



Código	Medida	Caja	EAN
90161	16 x 2	40	8435195824308
90162	18 x 2	40	8435195824315
90163	20 x 2	40	8435195824322

- Presión máxima: 10 Bar.
- Temperatura máxima: 100°C.

CONJUNTO TUERCA Y MANGUITO RACOR COLECTOR



Código	Medida	Caja	EAN
90170	1/2" sin junta	10	8435195827552
90171	1/2" con junta	10	8435195827569

CALEFACCIÓN

Florones y tapones

FLORON UNIVERSAL



	Código	Medida	Caja	EAN
Blanco	90260	8 a 22 mm Ø	10	8435195833423
Cromo	90261	12 a 18 mm Ø	10	8435195833430

TAPÓN RADIADOR ZINCADO Ø 42



	Código	Medida	Caja	EAN
Izquierda	90269	1" Ciego	10	8435195833492
	90271	1" x 1/8"	10	8435195833515
	90273	1" x 1/4"	10	8435195833539
	90275	1" x 3/8"	10	8435195833553
	90277	1" x 1/2"	10	8435195833577
Derecha	90268	1" ciego	10	8435195833485
	90270	1" x 1/8"	10	8435195833508
	90272	1" x 1/4"	10	8435195833522
	90274	1" x 3/8"	10	8435195833546
	90276	1" x 1/2"	10	8435195833560

TAPÓN RADIADOR BLANCO Ø 42



	Código	Medida	Caja	EAN
Izquierda	90279	1" Ciego	10	8435195833591
	90281	1" x 1/8"	10	8435195833614
	90259	1" x 1/4"	10	8435195833638
	90283	1" x 3/8"	10	8435195833706
	90285	1" x 1/2"	10	8435195833669
Derecha	90278	1" ciego	10	8435195833584
	90280	1" x 1/8"	10	8435195833607
	90258	1" x 1/4"	10	8435195833621
	90282	1" x 3/8"	10	8435195833645
	90284	1" x 1/2"	10	8435195833652

LLAVE UNIVAERSAL DE NYLON PARA TAPONES



Código	Medida	Caja	EAN
90266	1/2", 1" y 1 1/4"	1	8435195833447

KIT UNIVERSAL TAPONES Ø 42



Código	Descripción	Caja	EAN
90290	Zincado	1	8435195833676
90291	Blanco	1	8435195833683

• Contiene: 2 Reduc. 1" x 1/2" derecha, 2 Reduc. 1" x 1/2" izquierda, 4 juntas, 1 tapón 1/2" y 1 purgador 1/2".

CALEFACCIÓN

Termostatos y cronotermostatos

CABEZAL TERMOSTÁTICO CON SENSOR LÍQUIDO



Código	Medida	Caja	EAN
90120	3/8" x 1/2"	1	8435195824124

- Presión máxima de ejercicio: 10 Bar.
- Presión máxima diferencial: 1 Bar.
- Temperatura máxima ambiente: 40°C.
- Temperatura máxima agua instalación: 100°C.
- Campo de regulación: 7 - 28 °C.

VÁLVULA MONOTUBO TERMOSTATIZABLE



Código	Medida	Caja	EAN
90128	1/2" Derecha	1	8435195824155

- Presión máxima de ejercicio: 10 Bar.
- Roscas M 3/4"

CRONOTERMOSTATO ELECTRÓNICO SEMANAL



Código	Medida	Caja	EAN
90135	130 x 80 x 26	1	8435195824179

- Frontal transparente.

CRONOTERMOSTATO ELECTRÓNICO SEMANAL



Código	Medida	Caja	EAN
90136	130 x 80 x 26	1	8435195824186

- Frontal negro.

TERMOSTATO AMBIENTE MECÁNICO



Código	Medida	Caja	EAN
90137	90 x 90 x 40	1	8435195824193

CALEFACCIÓN

Soportes y complementos

CAJA COLECTOR ABS "PLASTIBOX"



Código	Medida	Caja	EAN
90031	310 x 310 x 90	5	8435195823882
90032	460 x 310 x 90	5	8435195823899
90033	610 x 310 x 90	5	8435195823905

PERFIL PARA CAJA COLECTOR "PLASTIBOX"



Código	Medida	Caja	EAN
90036	400 mm.	10	8435195823912

SOPORTE CAJA DE COLECTOR TIPO "CONTROLLER"



Código	Medida	Caja	EAN
90034	Colector 3/4"	10	8435195823929
90035	Colector 1"	10	8435195823936

SOPORTE CAJA DE COLECTOR TIPO "THERMODAY"



Código	Medida	Caja	EAN
90037	Colector 3/4"	10	8435195823943
90038	Colector 1"	10	8435195823950

SOPORTE RADIADOR REGULABLE

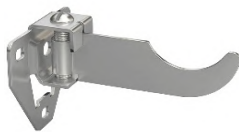

Cód. **90301**

Caja: 10 uds.

EAN 8435195833454

SOPORTE RADIADOR 1 PATILLA METAL



Cód. **90302**

Caja: 1 ud.

EAN 8435195833461

SOPORTE RADIADOR 1 PATILLA NYLON



Cód. **90306**

Caja: 10 ud.

EAN 8435195833478

CASQUILLO RADIADOR



Cód. **90296**







Caja: 10 ud.

EAN 8435195833690

Medida: 1" x 30 mm



JUNTAS Y ARANDELAS

Juntas tóricas		218
Juntas planas		219
Arandelas de goma		220
Juntas de fibra		220
Juntas klinger		221
Juntas de teflón		221



JUNTAS Y ARANDELAS

Juntas tóricas

ESTUCHE PARA JUNTAS

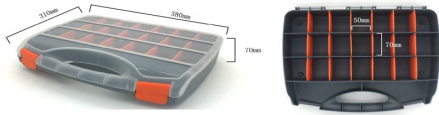

Código	Descripción	Caja	EAN
99520	Con separadores	1	8435195812732

JUNTAS TÓRICAS NBR-70 en pulgadas



	Código	AN	Medida	Caja	EAN
	83020	AN 00	2,20 x 1,60	50	8435195813975
	83001	AN 1	2,90 x 1,78	100	8435195813791
	83002	AN 2	3,68 x 1,78	100	8435195813807
	83003	AN 3	4,47 x 1,78	100	8435195813814
	83004	AN 4	5,28 x 1,78	100	8435195813821
1/4"	83005	AN 5	6,07 x 1,78	100	8435195813838
	83006	AN 6	7,65 x 1,78	100	8435195813845
	83007	AN 7	9,25 x 1,78	100	8435195813852
3/8"	83008	AN 8	9,19 x 2,62	100	8435195813869
	83009	AN 9	10,77 x 2,62	100	8435195813876
1/2"	83010	AN 10	12,37 x 2,62	100	8435195813883
	83011	AN 11	13,94 x 2,62	100	8435195813890
	83012	AN 12	15,54 x 2,62	100	8435195813906
3/4"	83013	AN 13	17,12 x 2,62	50	8435195813913
	83014	AN 14	18,64 x 2,62	50	8435195813920
	83015	AN 15	18,64 x 3,53	50	8435195813937
	83016	AN 16	20,22 x 3,53	50	8435195813944
	83017	AN 17	21,82 x 3,53	50	8435195813951
	83018	AN 18	23,39 x 3,53	50	8435195813968

ESTUCHE JUNTAS TÓRICAS NBR-70 en pulgadas

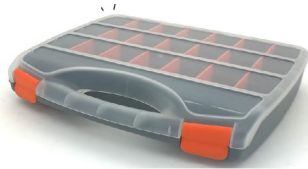

Código	Descripción	Caja	EAN
83019	18 medidas	650	8435195813982

• Contiene:

50 uds. de la Ref. 83001 a la 83007.
25 uds. de la Ref. 83008 a la 83018.

ESTUCHE JUNTAS TÓRICAS NBR-70 métrica



Código	Descripción	Caja	EAN
83065	19 medidas	650	8435195818116

• Contiene:

50 uds. de M 3 x 2 a M 10 x 2.
25 uds. de M 10 x 2,5 a M 25 x 3.

JUNTAS Y ARANDELAS

Juntas planas

JUNTAS PLANAS ANCHAS DE CAUCHO

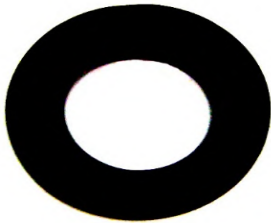

Código	Medida		Caja	EAN
83502	3/8"	8 x 14,5 x 2	100	8435195813999
83503	1/2"	10 x 18,5 x 2	100	8435195814002
83520	1/2"	10 x 18,5 x 4	100	8435195827767
83504	3/4"	12 x 23,5 x 2	100	8435195814019
83509	3/4"	13 x 23,5 x 3	100	8435195822687
83505	1"	20 x 30 x 2,5	100	8435195814026
83506	1 1/4"	29 x 37 x 2,5	100	8435195814033
83507	1 1/2"	30 x 44,5 x 2,5	100	8435195814040
83508	2"	46 x 56 x 2,5	100	8435195814057
99322	2 1/2"	57 x 69,5 x 3,5	10	8435195824667
99334	3"	70 x 82,5 x 3,5	10	8435195824674

JUNTAS PLANAS NORMALES DE CAUCHO



Código	Descripción		Caja	EAN
84002	3/8"	10 x 14,5 x 2	100	8435195814064
84003	1/2"	14 x 18,5 x 2	100	8435195814071
84004	3/4"	18 x 23,5 x 2	100	8435195814088
84005	1"	24 x 30 x 2,5	100	8435195814095
84006	1 1/4"	30 x 35 x 2,5	100	8435195814101
84007	1 1/2"	37 x 44,5 x 2,5	100	8435195814118
84008	2"	50 x 56 x 2,5	100	8435195814125

ESTUCHE JUNTAS PLANAS ANCHAS DE CAUCHO

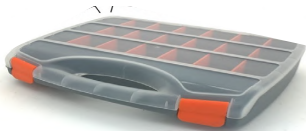

Código	Descripción	Caja	EAN
84009	7 medidas	425	8435195814132

• Contiene: 100 uds. 3/8", 1/2" y 3/4" - 50 uds. 1" - 25 uds. 1 1/4", 1 1/2" y 2".

ESTUCHE JUNTAS PLANAS NORMALES DE CAUCHO

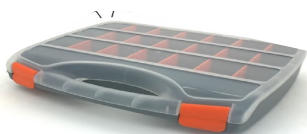

Código	Descripción	Caja	EAN
84011	7 medidas	425	8435195821390

• Contiene: 100 uds. 3/8", 1/2" y 3/4" - 50 uds. 1" - 25 uds. 1 1/4", 1 1/2" y 2".

ESTUCHE JUNTAS PLANAS MIXTAS DE CAUCHO

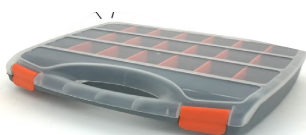

Código	Descripción	Caja	EAN
84010	7 medidas	425	8435195814149

• Contiene: ANCHAS: 100 uds. 3/8", 1/2" y 3/4" - 50 uds. 1"
NORMALES: 100 uds. 3/8", 1/2" y 3/4" - 50 uds. 1"

JUNTAS CON FILTRO INOXIDABLE



Código	Medida	Caja	EAN
83515	1/2"	25	8435195827774
83516	3/4"	25	8435195827781



JUNTAS Y ARANDELAS

Arandelas de goma y juntas de fibra

ARANDELAS DE GOMA BLANCA CÓNICAS



Código	Medida	Caja	EAN
84012	3/8" x 50	100	8435195814156
84013	1/2" x 51	100	8435195814163
84014	3/4" x 57	100	8435195814170
84015	1" x 61	100	8435195814187
84016	1 1/4" x 61	100	8435195814194
84017	1 1/2" x 66	50	8435195814200
84018	2" x 83	50	8435195814958

ARANDELAS DE GOMA BLANCA SEMICÓNICAS

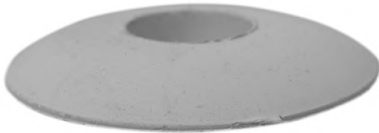

Código	Medida	Caja	EAN
84022	3/8" x 50	100	8435195814217
84023	1/2" x 51	100	8435195814224
84024	3/4" x 57	100	8435195814231
84025	1" x 61	100	8435195814248
84026	1 1/4" x 61	100	8435195814255
84027	1 1/2" x 66	50	8435195814262
84028	2" x 83	50	8435195820256

ARANDELAS DE GOMA BLANCA PLANAS



Código	Medida		Caja	EAN
84032	3/8"	16 x 32 x 2	100	8435195814279
84033	1/2"	20 x 45 x 2	100	8435195814286
84034	3/4"	25 x 60 x 2	100	8435195814293
84035	1"	35 x 70 x 2	100	8435195814309
84036	1 1/4"	40 x 70 x 2	100	8435195814316
84037	1 1/2"	45 x 70 x 2	100	8435195814323
84038	2"	50 x 80 x 2	100	8435195814330

JUNTAS PLANAS DE FIBRA



Código	Medida	Caja	EAN
84501	16 x 1,5	100	8435195814347
84502	17 x 1,5	100	8435195814354
84503	18 x 1,5	100	8435195814361
84504	19 x 1,5	100	8435195814378
84505	20 x 1,5	100	8435195814385
84506	21 x 1,5	100	8435195814392
84507	22 x 1,5	100	8435195814408

ESTUCHE JUNTAS PLANAS DE FIBRA

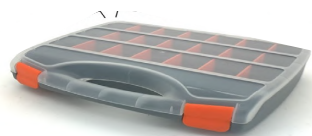

Código	Descripción	Caja	EAN
84508	7 medidas	700	8435195814415

• Contiene: 100 uds. por medida.

JUNTAS Y ARANDELAS

Juntas klinger y juntas de teflón

JUNTAS PLANAS KLINGER SIN AMIANTO



Código	Medida		Caja	EAN
84515	1/8"	racor	100	8435195814422
84516	1/4"	racor	100	8435195814439
84517	3/8"	racor	100	8435195814446
84518	1/2" x 10	flexo	100	8435195814453
84519	1/2" x 12	racor	100	8435195820263
84520	1/2" x 14	racor	100	8435195814460
84521	3/4" x 13	batería	100	8435195814477
84522	3/4" x 17	batería	100	8435195814484
84523	3/4" x 18	racor	100	8435195814491
84524	1"	racor	100	8435195814507
84525	1"	ancha	100	8435195814514
84528	1"	radiador	100	8435195814521
84514	1 1/4"	racor	100	8435195814538
84526	1 1/4"	ancha	100	8435195814545
84527	1 1/2"	ancha	100	8435195814552
84532	2"	racor	25	8435195833713
84555	2"	ancha	25	8435195833720

ESTUCHE JUNTAS PLANAS KLINGER SIN AMIANTO

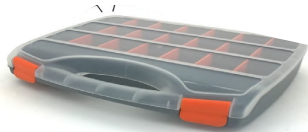

Código	Descripción	Caja	EAN
84529	14 medidas	950	8435195814569

Contiene:
 100 uds. (1/8" - 1/4" - 3/8" - 1/2"x10 - 1/2"x12 - 1/2"x14)
 50 uds. (3/4"x17 - 3/4"x18 - 1"racor - 1"ancha)
 25 uds. 1"radiador - 1 1/4" - 1 1/2"

JUNTAS PLANAS DE TEFLÓN



Código	Medida		Caja	EAN
84535	3/8"	14'5 x 7 x 1'5	100	8435195814576
84536	3/8"	14'5 x 10 x 1'5	100	8435195814583
84537	1/2" x 10	18'5 x 10 x 1'5	100	8435195814590
84538	1/2" x 12	18'5 x 12 x 1'5	100	8435195814606
84539	1/2" x 14	18'5 x 14 x 1'5	100	8435195814613
84540	3/4" x 13	24 x 13 x 1'5	100	8435195814620
84541	3/4" x 18	24 x 18 x 1'5	100	8435195814637
84542	3/4" x 19	24 x 19 x 1'5	100	8435195814644
84533	7/8"	27 x 21 x 1'5	100	8435195814651
84543	1"	30 x 24 x 1'5	100	8435195814668
84544	1 1/4"	39 x 30 x 1'5	100	8435195814675
84545	1 1/2"	45 x 37 x 1'5	100	8435195814682
84546	1"	42 x 33 x 1'5	100	8435195814699
84547	1 1/4"	50 x 41 x 1'5	100	8435195814705
84549	1"	30 x 20 x 1'5	100	8435195814712
84550	2"	57 x 49 x 1'5	100	8435195820270

ESTUCHE JUNTAS PLANAS DE TEFLÓN



Código	Descripción	Caja	EAN
84548	13 medidas	825	8435195812190

Contiene:
 100 uds. (3/8"x7 - 3/8"x10 - 1/2"x10 - 1/2"x12 - 1/2"x14)
 50 uds. (3/4"x13 - 3/4"x18 - 3/4"x19 - 1"x24 - 1"x33)
 25 uds. (1 1/4"x30 - 1 1/4"x 41 - 1 1/2"x37)



MEMBRANAS

Membranas



224

MEMBRANAS

MEMBRANAS PARA CALENTADOR



Marca	Código	Nº	Descripción	Caja	EAN
Cointra Agni Corcho	88041	2	5 l. antiguo	25	8435195815658
	88042	3	10 l. moderno	25	8435195815665
	88043	19	10 l. antiguo	25	8435195815672
	88044	0	5 l. Cointra	25	8435195815689



Fagor Aspes	88045	4	5 l. David	25	8435195815696
	88046	5	5 l. 5 K moderno	25	8435195844900
	88047	6	5l. 10 TE antiguo	25	8435195815719
	88048	7	5l. 10TE 10K moderno	25	8435195815726
	88049	8	10 l. Bules moderno	25	8435195815733
88050	33	5l. D15 D50 moderno	25	8435195815740	



Otsein	88051	9	5 l. y 10 l. antiguo baja presión	25	8435195815757
	88052	10	5 l. y 10 l. moderno	25	8435195815764
	88053	11	5 l. y 10 l. moderno	25	8435195815771



Balay	88054	12	5 l. 7 l. 10 l. moderno	25	8435195815788
Aitona	88055	37	Alta y baja presión	25	8435195815795
Fuima	88056	38	Alta y baja presión	25	8435195815801



Junkers	88057	13	5 l. moderno FD-330	25	8435195815818
	88059	25	5 l. antiguo	25	8435195815832
	88060	26	10 l. antiguo	25	8435195815849

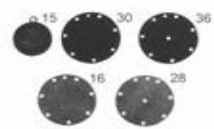

Corberó	88061	15	5 l. moderno C-51 y C-52	25	8435195815856
	88062	30	5 l. antiguo LM-8 baja presión	25	8435195815863
	88063	36	10 l. moderno LM25/LM-26	25	8435195815870
	88064	16	5 l. LM-8 presión normal	25	8435195815887
	88065	28	10 l. LM25/LM26 presión normal	25	8435195815894



Orbegozo	88066	17	10 l. moderno	25	8435195815900
	88067	18	5 l. antiguo	25	8435195815917



Vaillant	88068	22	10 l. moderno	25	8435195815900
	88069	20	5 l. antiguo	25	8435195815917



Saunier	88070	21	5 l. moderno	25	8435195815948
Duval	88071	23	10 l. moderno	25	8435195815955



Chafoteaux	88072	27	5 l. y 10 l. moderno	25	8435195815818
	88073	34	Roca - Chafoteaux	25	8435195815825
Roca	88074	35	Chafoteaux	25	8435195815832
	88075	24	Tropik	25	8435195815849

SOLETAS Y PORTASOLETAS

Soletas y portasoletas



226

SOLETAS Y PORTASOLETAS

PORTASOLETAS DE ACERO INOXIDABLE



Código	Medida	Caja	EAN
87001	16/150	100	8435195815283
87002	17/150	100	8435195815290
87003	18/150	100	8435195815306
87004	19/150	100	8435195815313

PORTASOLETAS DE LATÓN



Código	Medida	Caja	EAN
99166	3/4"	100	8435195815320

• Sirve para la soleta de 20 x 4 x 4 - Cód. 88008.

SOLETAS DE CAUCHO



	Código	Medida	Caja	EAN
Nº 8	88001	12 x 4 x 4	100	8435195815351
	88002	13 x 4 x 4	100	8435195815368
Nº 11	88003	14 x 4 x 4	100	8435195815375
	88004	15 x 4 x 4	100	8435195815382
Nº 13	88005	16 x 4 x 4	100	8435195815399
	88006	17 x 4 x 4	100	8435195815405
Nº 16	88007	18 x 4 x 4	100	8435195815412
Nº 20	88008	20 x 4 x 4	100	8435195815429
	88026	24,5 x 5 x 5	100	8435195828122

SOLETAS DE CAUCHO CIEGAS



	Código	Medida	Caja	EAN
Nº 8	88010	12 x 4 x 4	100	8435195815443
	88011	13 x 4 x 4	100	8435195815450
Nº 11	88012	14 x 4 x 4	100	8435195815467
	88013	15 x 4 x 4	100	8435195815474
Nº 13	88014	16 x 4 x 4	100	8435195815481
	88015	17 x 4 x 4	100	8435195815498
Nº 16	88016	18 x 4 x 4	100	8435195815504
Nº 20	88017	20 x 4 x 4	100	8435195815511
	88018	27 x 5 x 4	100	8435195844870

ESTUCHE DE SOLETAS DE CAUCHO



Código	Descripción	Caja	EAN
88009	16 medidas	800	8435195815436

• Contiene:

50 uds. de la Ref. 88001 a la 88008.

50 uds. de la Ref. 88010 a la 88017.

ACCESORIOS DE SELLADO

Rollo de teflón		228
Cáñamo		228
Pasta tipo Unibond		228
Hilo sellador		228
Tefón líquido		228
Lana de acero		228
Cinta adhesiva		229
Carrete estaño plata y cobre		229
Gel decapante		229

ACCESORIOS DE SELLADO

ROLLO DE TEFLÓN



	Código	Medida	Caja	EAN
	73001	12 m.x12mm.x0,075mm.	250	8435195812169
Gas	73003	12 m.x12mm.x0,10mm.	250	8435195812176
Polietileno	73004	50 m.x19mm.x0,10mm.	63	8435195812183

MADEJA DE CÁÑAMO



Código	Medida	Caja	EAN
73007	200 gr.	1	8435195822694

PASTA TIPO UNIBOND PARA ROSCAR CON CÁÑAMO



Código	Medida	Caja	EAN
73008	400 gr.	1	8435195822700

HILO SELLADOR DE TUBERÍAS

Cód. **73005**

Caja: 10 uds.

EAN 8435195815634

160 metros



TEFLÓN LÍQUIDO P.T.F.E. SEAL

Cód. **99069**

Caja: 1 ud.

EAN 8435195846461

50 gr.



Cód. **73006**

Caja: 10 uds.

EAN 8435195815702

50 metros



Cód. **99070**

Caja: 1 ud.

EAN 8435195848083

100 gr.

BOLSA DE LANA ACERO



Código	Medida	Caja	EAN
73009	63 grs.	1	8435195824995

ACCESORIOS DE SELLADO

CINTA ADHESIVA



Código	Medida	Caja	EAN
73015	50 m. x 50 mm.	10	8435195827798
73016	10 m. x 50 mm.	10	8435195827804
73017	25 m. x 50 mm.	10	8435195827811

CARRETE ESTAÑO PLATA TIPO MAR-PLUS



Código	Descripción	Caja	EAN
49096	3,5% - 250 gr.	10	8435195806526
49097	6% - 250 gr.	10	8435195806533

CARRETE ESTAÑO COBRE PARA SOLDAR GAS TIPO MAR-PLUS



Código	Descripción	Caja	EAN
49095	6% - 250 gr.	10	8435195838619





GEL DECAPANTE FLUX



Código	Descripción	Caja	EAN
49098	100 gr.	10	8435195806540



ACCESORIOS PARA GAS

Reguladores de butano		232
Goma de butano		232
Gas hermeto y soldar		233
Soportes y tapas de contador		237

ACCESORIOS PARA GAS

REGULADOR BOTELLA DE BUTANO



Código	Descripción	Caja	EAN
73030	Doméstico	1	8435195827828

- Regulador para botella doméstica.
- Presión salida regulada 30 mbar.
- Caudal 2,5 kg/h.
- Salida a manguera 9 mm. Ø interior.
- Standard K-30.



Código	Descripción	Caja	EAN
73032	Con corte	1	8435195827825

- Regulador para botella doméstica.
- Presión salida regulada 30 mbar.
- Caudal 2,5 kg/h.
- Salida a manguera 9 mm. Ø interior.
- Con corte por exceso de flujo.



Código	Descripción	Caja	EAN
73031	Salida libre	1	8435195827835

- Presión salida regulada hasta 1,7 bar.
- Mando negro.
- Sistema acople rápido.
- Salida rosca izquierda 21,8.

RACORD ACOPLAMIENTO REGULADOR



Cód. **73033**

Caja: 1 ud.

EAN 8435195848069

Rosca izq. 21,8

TETINA DE ACOPLAMIENTO A MANGUERA



Cód. **89004**

Caja: 1 ud.

EAN 8435195844924

Tuerca 20x150, 21,8 izq. y 1/2"gas

ROLLO MANGUERA GAS BUTANO



Cód. **73036**

Caja: 1 ud.

EAN 8435195827859

60 metros

MANGUERA GAS BUTANO 1,5 M



Cód. **73037**

Caja: 1 ud.

EAN 8435195827866

1,5 m. con 2 abrazaderas

ACCESORIOS PARA GAS

Gas hermeto

UNIÓN HERMETO CROMO



Código	Medida	Caja	EAN
89002	10 x 10	25	8435195816006
89003	12 x 12	25	8435195816013

	Código	Medida	Caja	EAN
Reducida	89006	10 x 12	25	8435195816037

REDUCCIÓN HERMETO CROMO

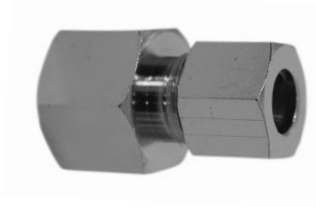

Código	Medida	Caja	EAN
89007	1/2" x 10	25	8435195816044
89008	1/2" x 12	25	8435195816051
89009	3/4" x 10	25	8435195816068
89010	3/4" x 12	25	8435195816075

BOQUILLA HERMETO CROMO



Código	Medida	Caja	EAN
89012	10 Ø	25	8435195816082
89013	12 Ø	25	8435195816099

CODO HERMETO CROMO

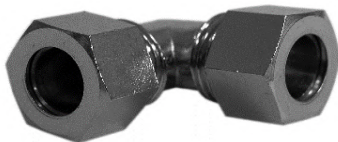

Código	Medida	Caja	EAN
89017	10 x 10	25	8435195816198
89018	12 x 12	25	8435195816204

TE HERMETO CROMO



Código	Medida	Caja	EAN
89021	10 x 10 x 10	25	8435195816211
89022	12 x 12 x 12	25	8435195816228

ACCESORIOS PARA GAS

Gas soldar

UNIÓN SOLDAR S/COLOR

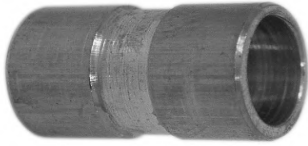

Código	Medida	Caja	EAN
89046	10 x 10	50	8435195816389
89047	12 x 12	50	8435195816396

Reducida	89048	10 x 12	50	8435195816402
-----------------	--------------	---------	----	---------------

BOQUILLA LISA SOLDAR S/COLOR



Código	Medida	Caja	EAN
89015	10 Ø	50	8435195816105
89016	12 Ø	50	8435195816112

BOQUILLA SOLDAR S/COLOR



Código	Medida	Caja	EAN
89050	10 Ø	50	8435195816129
89051	12 Ø	50	8435195816136

BOQUILLA SOLDAR CANARIAS S/COLOR

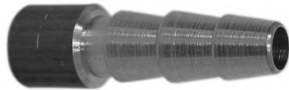

Código	Medida	Caja	EAN
89052	10 Ø	50	8435195816143

CODO SOLDAR S/COLOR



Código	Medida	Caja	EAN
89071	10 x 10	25	8435195816150
89073	12 x 12	25	8435195816167

TE SOLDAR S/COLOR



Código	Medida	Caja	EAN
89072	10 x 10 x 10	25	8435195816174
89074	12 x 12 x 12	25	8435195816181

ACCESORIOS PARA GAS

TUERCA HERMETO CROMO



Código	Medida	Caja	EAN
89024	10 Ø	100	8435195816235
89025	12 Ø	100	8435195816242

BICONO HERMETO LATÓN



Código	Medida	Caja	EAN
89027	10 Ø	100	8435195816280
89028	12 Ø	100	8435195816297

TUERCA VÁLVULA GAS SOLDAR CROMO



Código	Medida	Caja	EAN
89026	10 Ø	25	8435195816259

MANGUITO VÁLVULA GAS SOLDAR LATÓN

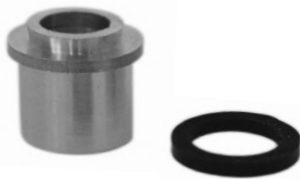

Código	Medida	Caja	EAN
89044	10 Ø	25	8435195816266

Código	Descripción	Caja	EAN
89043	Junta manguito	25	8435195816273

MANGUITO SOLDAR S/COLOR



Código	Medida	Caja	EAN
89038	20/150 x 10 Ø	100	8435195816341
89039	20/150 x 12 Ø	100	8435195816358
89040	1/2" x 14 Ø	100	8435195816365
89041	1/2" x 15 Ø	100	8435195816372

Código	Descripción	Caja	EAN
89042	Junta manguito	100	8435195815337

TUERCA CONEXIÓN GAS JUNTA PLANA CROMO



Código	Medida	Caja	EAN
89033	20/150 x 15 Ø	100	8435195816303
89034	21,8 izq. X 15 Ø	100	8435195816310
89035	1/2" x 15 Ø	100	8435195816327
89036	1/2" x 17 Ø	100	8435195816334

CONJUNTO TUERCA Y BICONO COMPRESIÓN



Código	Medida	Caja	EAN
99361	3/8" x 10 Ø	50	8435195812237
99364	1/2" x 10 Ø	50	8435195812244

ACCESORIOS PARA GAS

VÁLVULA HERMETO GAS BUTANO



Código	Medida	Caja	EAN
89056	10 x 10	120	8435195816556
89057	12 x 12	120	8435195816563

VÁLVULA SOLDAR GAS BUTANO



Código	Medida	Caja	EAN
89053	10 x 10	120	8435195816532
89054	12 x 12	120	8435195816549

VÁLVULA PROPANO NATURAL



Código	Medida	Caja	EAN
89062	20/150 x 20/150	120	8435195816570
89063	21,8 izq. X 21,8 izq.	120	8435195816587
89064	1/2" x 1/2"	120	8435195816594
89066A	3/4" x 3/4"	60	8435195816600

- Conexión junta plana.

DERIVACIÓN BOQUILLA HERMETO CROMO



Código	Medida	Caja	EAN
89070	10 Ø	25	8435195816426

DERIVACIÓN BOQUILLA 3 SALIDAS S/COLOR



Código	Medida	Caja	EAN
89069	10 Ø	25	8435195816419

ABRAZADERA TUBO



Código	Medida	Caja	EAN
89066	10 Ø	500	8435195816433
89067	12 Ø	500	8435195816440

- Incluye taco y tornillo.

ABRAZADERA GOMA



Código	Medida	Caja	EAN
89068	14 x 16	100	8435195816457
89069A	16 x 18	100	8435195816464

ACCESORIOS PARA GAS

SOPORTE CONTADOR GAS FRONTAL



Código	Medida	Caja	EAN
89095	21,5 x 11,5 x 6 cm.	50	8435195816471

- Blanco.

SOPORTE CONTADOR GAS LATERAL

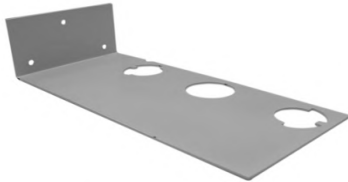

Código	Medida	Caja	EAN
89096	27 x 12 x 6 cm.	40	8435195816488

- Blanco.

TAPA PARA CONTADOR DE GAS

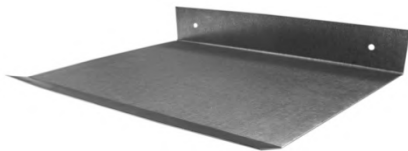

Código	Descripción	Caja	EAN
890101	Frontal	50	8435195816495
890102	Lateral	40	8435195816501
890103	Especial	40	8435195816518
890104	Separadora	30	8435195816525

- Chapa galvanizada.



ACCESORIOS DE VENTILACIÓN

Rejillas



240

Difusores



242



ACCESORIOS VENTILACIÓN

Rejillas metálicas

REJILLA EMPOTRAR



	Código	Descripción	Caja	EAN
17 x 17	60001	Blanco	100	8435195808940
	60002	Aluminio	100	8435195808957
	60003	Color madera	100	8435195808964
	60004	Aluminio blanco	100	8435195808971



	Código	Descripción	Caja	EAN
20 x 20	60005	Blanco	80	8435195808988
	60006	Aluminio	80	8435195808995

REJILLA PLANA



	Código	Descripción	Caja	EAN
10 x 10	60011	Blanco	100	8435195809015
	60012	Aluminio	100	8435195809022
	60014	Color madera	100	8435195809046
	60013	Aluminio blanco	100	8435195809046

15 x 15	60501	Blanco	100	8435195809091
	60502	Aluminio	100	8435195809107
	60503	Color madera	100	8435195809114
	60504	Aluminio blanco	100	8435195809121

17 x 17	60506	Blanco	100	8435195809138
	60507	Aluminio	100	8435195809145
	60508	Color madera	100	8435195809152
	60509	Aluminio blanco	100	8435195809169

20 x 20	60511	Blanco	100	8435195809176
	60512	Aluminio	100	8435195809183
	60513	Aluminio blanco	100	8435195809190

REJILLA PLANA



	Código	Descripción	Caja	EAN
20 x 10	60016	Blanco	100	8435195809053
	60017	Aluminio	100	8435195809060
	60018	Aluminio blanco	100	8435195809077



	Código	Descripción	Caja	EAN
15 X 30	60515	Blanco	100	8435195809213
	60516	Aluminio	100	8435195809220
	60505	Aluminio blanco	100	8435195809244

ACCESORIOS VENTILACIÓN

Rejillas ABS

REJILLA EMPOTRAR CUADRADA



	Código	Descripción	Caja	EAN
15 x 15	60528	Blanco	50	8435195809312
Sin cierre				

	Código	Descripción	Caja	EAN
17 x 17	60518	Blanco	50	8435195809251
Sin cierre	60519	Color madera	50	8435195809268



	Código	Descripción	Caja	EAN
17 x 17	60533	Blanco	50	8435195841282
Con cierre				

	Código	Descripción	Caja	EAN
20 x 20	60534	Blanco	50	8435195841299
Con cierre				

MARCO REJILLA CUADRADA



	Código	Descripción	Caja	EAN
15 x 15	60529	Blanco	50	8435195809367
17 x 17	60522	Blanco	50	8435195809329

REJILLA EMPOTRAR RECTANGULAR



	Código	Descripción	Caja	EAN
22 x 9,5	60520	Blanco	100	8435195809275
Sin cierre	60521	Color madera	100	8435195809282

	Código	Descripción	Caja	EAN
22 x 9,5	60536	Blanco	50	8435195841312
Con cierre				

MARCO REJILLA RECTANGULAR



	Código	Descripción	Caja	EAN
22 x 9,5	60524	Blanco	50	8435195809343
	60525	Color madera	50	8435195809350

REJILLA EMPOTRAR REDONDA



	Código	Descripción	Caja	EAN
15 cm. Ø	60526	Blanco	100	8435195809299
	60527	Color madera	100	8435195809305

MARCO REJILLA REDONDA



	Código	Descripción	Caja	EAN
15 cm. Ø	60530	Blanco	50	8435195809374



ACCESORIOS VENTILACIÓN

Rejillas ABS y difusores

REJILLA Y MARCO



	Código	Descripción	Caja	EAN
17 x 17	60537	Blanco	50	8435195841329
Sin cierre				

	Código	Descripción	Caja	EAN
20 x 20	60539	Blanco	50	8435195841336
Sin cierre				

	Código	Descripción	Caja	EAN
22 x 9,5	60540	Blanco	50	8435195841343
Sin cierre				

	Código	Descripción	Caja	EAN
15 cm. Ø	60541	Blanco	50	8435195841350

MOSQUITERA REJILLA

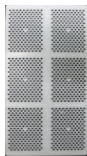

	Código	Descripción	Caja	EAN
22 x 9,5	60532	Blanco	50	8435195833751

DIFUSOR 2 DISCOS HIERRO BLANCO



Código	Medida	Caja	EAN
61001	100 Ø	64	8435195809398
61002	110 Ø	64	8435195809404
61003	120 Ø	64	8435195809411
61004	125 Ø	64	8435195809428
61005	130 Ø	64	8435195809435

DIFUSOR 3 DISCOS HIERRO BLANCO





Código	Medida	Caja	EAN
61101	100 Ø	48	8435195809442
61102	110 Ø	48	8435195809459
61103	120 Ø	48	8435195809466
61104	125 Ø	48	8435195809473
61105	130 Ø	48	8435195809480

DIFUSOR 3 DISCOS ALUMINIO BLANCO



Código	Medida	Caja	EAN
61120	100 Ø	18	8435195825008
61121	110 Ø	18	8435195825015
61122	120 Ø	18	8435195825022
61123	125 Ø	18	8435195825039
61124	130 Ø	18	8435195825046

SUMIDEROS, CALDERETAS Y BOTE SIFÓNICO

Sumideros		244
Calderetas		244
Bote sifónico		244

SUMIDEROS, CALDERETAS Y BOTE SIFÓNICO

SUMIDERO DE LATÓN CROMADO



Código	Medida	Caja	EAN
25522	10 x 10	2	8435195817812

SUMIDERO SIFÓNICO PVC

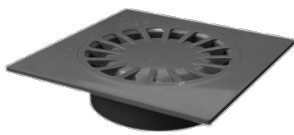

	Código	Medida	Caja	EAN
10 x 10	25534	Salida 50 Vertical/Horizontal	2	8435195824353

	Código	Medida	Caja	EAN
15 x 15	25535	Salida 75 - 50	2	8435195817829

	Código	Medida	Caja	EAN
20 x 20	25536	Salida 110 - 90	2	8435195817836

	Código	Medida	Caja	EAN
25 x 25	25537	Salida 110 - 90	2	8435195817843

CALDERETA SIFÓNICA PVC



	Código	Medida	Caja	EAN
10 x 10	25542	Salida 50 Vertical/Horizontal	2	8435195824360

	Código	Medida	Caja	EAN
15 X 15	25538	Salida 75 - 50	2	8435195817850

	Código	Medida	Caja	EAN
20 x 20	25539	Salida 110 - 90	2	8435195817867

	Código	Medida	Caja	EAN
25 x 25	25540	Salida 110 - 90	2	8435195817874

BOTE SIFÓNICO PVC



Código	Descripción	Caja	EAN
25541	110 mm.	2	8435195817881

ACCESORIOS DE COBRE

Racor recto		246
Racor curvo		248
Manguitos		249
Codos		250
Tapón Hembra		251
Curva de 90°		251
Curva de 45°		252
Curvas desviación		252
Te H-H-H		253

ACCESORIOS DE COBRE

RACOR CON ALOJAMIENTO DE JUNTAS sin precinto

RECTO 359GCU

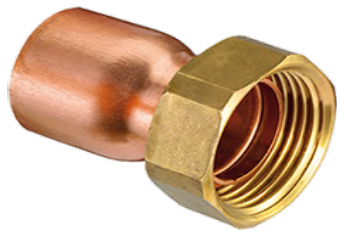

Código	Medida	Caja	EAN
49201	10 x 3/8"	25	8435195828436
49202	12 x 3/8"	25	8435195828443
49206	12 x 1/2"	25	8435195828450
49207	14 x 1/2"	25	8435195828467
49212	14 x 3/4"	25	8435195838701
49204	15 x 3/8"	25	8435195828474
49208	15 x 1/2"	25	8435195828481
49213	15 x 3/4"	25	8435195828498
49209	16 x 1/2"	25	8435195828504
49214	16 x 3/4"	25	8435195828511
49210	18 x 1/2"	25	8435195828528
49215	18 x 3/4"	25	8435195828535
49211	22 x 1/2"	25	8435195828542
49216	22 x 3/4"	25	8435195828559
49217	22 x 1"	10	8435195828566
49219	28 x 3/4"	25	8435195838718
49218	28 x 1"	10	8435195828580
49221	28 x 1 1/4"	10	8435195828597
49222	35 x 1 1/4"	10	8435195828603
49224	42 x 1 1/2"	10	8435195828610
49226	54 x 2"	5	8435195828627

RACOR CON JUNTA PLANA sin precinto

RECTO 359GCU

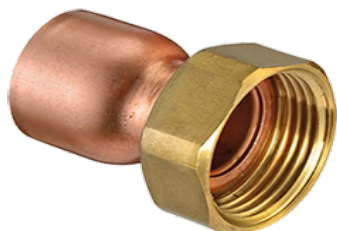

Código	Medida	Caja	EAN
49234	12 x 1/2"	25	8435195838770
49236	15 x 1/2"	25	8435195828634
49241	15 x 3/4"	25	8435195828641
49242	16 x 3/4"	25	8435195838817
49238	18 x 1/2"	25	8435195828658
49243	18 x 3/4"	25	8435195828665
49244	22 x 1/2"	25	8435195828672
49239	22 x 3/4"	25	8435195828689
49246	22 x 1"	25	8435195828696
49245	28 x 3/4"	25	8435195828702
49247	28 x 1"	25	8435195828719
49248	28 x 1 1/4"	25	8435195828726
49249	35 x 1 1/4"	25	8435195828733
49250	42 x 1 1/2"	25	8435195828740
49252	54 x 2"	25	8435195828757

ACCESORIOS DE COBRE

RACOR CON ALOJAMIENTO DE JUNTAS con precinto

RECTO 359GCU Con precinto

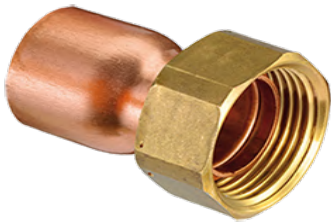

Código	Medida	Caja	EAN
49262	12 x 1/2"	25	8435195828764
49263	14 x 1/2"	25	8435195828771
49264	15 x 1/2"	25	8435195828788
49270	15 x 3/4"	25	8435195828825
49265	16 x 1/2"	25	8435195828795
49267	18 x 1/2"	25	8435195828801
49271	18 x 3/4"	25	8435195828832
49286	18 x 1"	25	8435195838916
49268	22 x 1/2"	25	8435195828818
49272	22 x 3/4"	25	8435195828849
49281	22 x 7/8"	25	8435195838862
49273	28 x 3/4"	25	8435195828856
49276	28 x 1"	10	8435195828863
49277	28 x 1 1/4"	10	8435195828870
49278	35 x 1 1/4"	10	8435195828887
49280	42 x 1 1/2"	10	8435195828894
49283	42 x 2"	10	8435195838886
49282	64 x 2 1/2"	10	8435195838879
49284	15 x 20/150	25	8435195838893
49285	18 x 20/150	25	8435195838909

RACOR CON JUNTA PLANA con precinto

RECTO 359GCU Con precinto

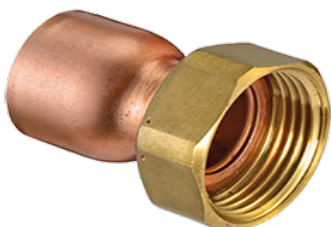

Código	Medida	Caja	EAN
49301	12 x 3/8"	25	8435195828900
49302	12 x 1/2"	25	8435195828917
49304	15 x 1/2"	25	8435195828924
49309	15 x 3/4"	25	8435195828931
49305	16 x 1/2"	25	8435195828948
49306	18 x 1/2"	25	8435195828955
49312	18 x 3/4"	25	8435195828962
49307	22 x 1/2"	25	8435195828979
49314	22 x 3/4"	25	8435195828986
49315	28 x 3/4"	25	8435195828993
49316	28 x 1"	10	8435195829006
49317	28 x 1 1/4"	10	8435195829013
49318	35 x 1 1/4"	10	8435195829020
49319	42 x 1 1/2"	10	8435195829037

ACCESORIOS DE COBRE

RACOR CURVO CON ALOJAMIENTO DE JUNTAS sin precinto

CURVO 2AGCU

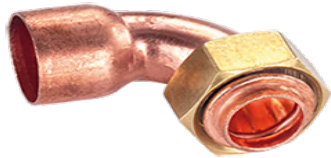

Código	Medida	Caja	EAN
49326	12 x 3/8"	25	8435195829044
49329	12 x 1/2"	25	8435195833768
49330	14 x 1/2"	25	8435195829068
49331	15 x 1/2"	25	8435195829075
49334	15 x 3/4"	25	8435195829358
49332	16 x 1/2"	25	8435195829082
49333	18 x 1/2"	25	8435195829099
49336	18 x 3/4"	25	8435195829105
49337	22 x 3/4"	25	8435195829112
49338	22 x 1"	10	8435195829129

RACOR CURVO CON JUNTA PLANA sin precinto

CURVO 2AGCU



Código	Medida	Caja	EAN
49367	12 x 1/2"	25	8435195829198
49368	15 x 1/2"	25	8435195829204
49371	15 x 3/4"	25	8435195829228
49372	16 x 3/4"	25	8435195829235
49370	18 x 1/2"	25	8435195829211
49373	18 x 3/4"	25	8435195829242
49374	22 x 3/4"	25	8435195829599
49375	22 x 1"	10	8435195833775
49376	28 x 1"	10	8435195833782

RACOR CURVO CON ALOJAMIENTO DE JUNTAS con precinto

CURVO 2AGCU con precinto

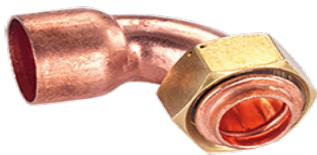

Código	Medida	Caja	EAN
49350	12 x 1/2"	25	8435195829136
49352	15 x 1/2"	25	8435195829143
49355	15 x 3/4"	25	8435195829167
49354	18 x 1/2"	25	8435195829150
49356	18 x 3/4"	25	8435195829174
49357	22 x 3/4"	25	8435195829181

RACOR CURVO CON JUNTA PLANA con precinto

CURVO 2AGCU con precinto



Código	Medida	Caja	EAN
49381	12 x 1/2"	25	8435195829266
49382	15 x 1/2"	25	8435195829273
49384	15 x 3/4"	25	8435195829297
49385	16 x 3/4"	25	8435195829303
49383	18 x 1/2"	25	8435195829280
49386	18 x 3/4"	25	8435195829310
49387	22 x 3/4"	25	8435195829327
49388	22 x 1"	25	8435195829334
49389	28 x 1"	25	8435195829341

ACCESORIOS DE COBRE

MANGUITO REDUCCION H-H

FIGURA 5240



Código	Medida	Caja	EAN
49405	12 X 10	10	8435195829365
49406	14 X 12	10	8435195829372
49407	15 X 10	10	8435195829389
49408	15 X 12	10	8435195829396
49409	15 X 14	10	8435195829402
49410	16 X 12	10	8435195829419
49411	16 X 14	10	8435195829426
49412	16 X 15	10	8435195829433
49413	18 X 12	10	8435195829440
49414	18 X 14	10	8435195829457
49415	18 X 15	10	8435195829464
49416	18 X 16	10	8435195829471
49417	22 X 12	10	8435195829488
49418	22 X 14	10	8435195829495
49419	22 X 15	10	8435195829501
49420	22 X 16	10	8435195829518
49421	22 X 18	10	8435195829525
49422	28 X 12	10	8435195829532
49423	28 X 15	10	8435195829549
49424	28 X 18	10	8435195829556
49425	28 X 22	10	8435195829563
49427	35 X 18	10	8435195829570
49428	35 X 22	10	8435195829587
49429	35 X 28	10	8435195859594
49432	42 X 28	5	8435195829600
49435	42 X 35	5	8435195829617
49440	54 x 28	5	8435195839067
49436	54 x 35	5	8435195839043
49433	54 X 42	5	8435195829624
49437	64 x 35	1	8435195839050
49434	64 X 54	1	8435195829631
49441	67 X 54	1	8435195829648
49442	76 X 54	1	8435195829655
49443	76 X 64	1	8435195829662

ACCESORIOS DE COBRE

MANGUITO REDUCCION M-H

FIGURA 5243

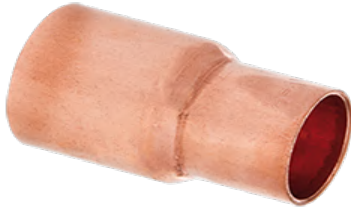

Código	Medida	Caja	EAN
49448	12 x 10	10	8435195829679
49449	14 x 12	10	8435195829686
49450	15 x 10	10	8435195829693
49451	15 x 12	10	8435195829709
49452	15 x 14	10	8435195829716
49453	16 x 12	10	8435195829723
49454	16 x 14	10	8435195829730
49455	18 x 12	10	8435195829747
49456	18 x 14	10	8435195829754
49457	18 x 15	10	8435195829761
49458	18 x 16	10	8435195829778
49459	22 x 12	10	8435195829785
49460	22 x 14	10	8435195829792
49461	22 x 15	10	8435195829808
49462	22 x 16	10	8435195829815
49463	22 x 18	10	8435195829822
49464	28 x 12	10	8435195829839
49465	28 x 14	10	8435195829846
49466	28 x 15	10	8435195829853
49467	28 x 16	10	8435195829860
49468	28 x 18	10	8435195829877
49469	28 x 22	10	8435195829884
49470	35 x 15	10	8435195829891
49471	35 x 18	10	8435195829907
49472	35 x 22	10	8435195829914
49473	35 x 28	10	8435195829921
49474	42 x 18	5	8435195829938
49475	42 x 22	5	8435195829945
49476	42 x 28	5	8435195829952
49477	42 x 35	5	8435195829969
49478	54 x 28	5	8435195829976
49479	54 x 35	5	8435195829983
49480	54 x 42	5	8435195829990
49481	64 x 54	1	8435195830002
49482	67 x 54	1	8435195830019
49483	76 x 54	1	8435195830026
49484	76 x 64	1	8435195830033
49485	80 x 67	1	8435195830040

ACCESORIOS DE COBRE

MANGUITO CON TOPE H-H

FIGURA 5270

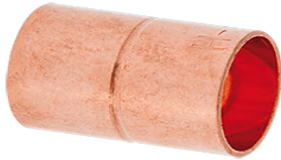

Código	Medida	Caja	EAN
49703	10	10	8435195830057
49704	12	10	8435195830064
49705	14	10	8435195830071
49706	15	10	8435195830088
49707	18	10	8435195830095
49708	22	10	8435195830101
49709	28	10	8435195830118
49710	35	10	8435195830125
49711	42	5	8435195830132
49712	54	5	8435195830149
49713	64	1	8435195830156
49714	66,7	1	8435195830163
49715	76,1	1	8435195830170
49716	80	1	8435195830187
49718	108	1	8435195830194

CODO 90° H-H

FIGURA 5090



Código	Medida	Caja	EAN
49600	10	10	8435195830200
49601	12	10	8435195830217
49602	14	10	8435195830224
49603	15	10	8435195830231
49604	16	10	8435195830248
49605	18	10	8435195830255
49606	22	10	8435195830262
49607	28	10	8435195830279
49608	35	5	8435195830286
49609	42	5	8435195830293
49610	54	1	8435195830309
49611	64	1	8435195830316
49612	66,7	1	8435195830323
49613	76,1	1	8435195830330
49614	80	1	8435195830347
49615	108	1	8435195830354

CODO 90° M-H

FIGURA 5092



Código	Medida	Caja	EAN
49616	10	10	8435195830361
49617	12	10	8435195830378
49618	14	10	8435195830385
49619	15	10	8435195830392
49620	16	10	8435195830408
49621	18	10	8435195830415
49622	22	10	8435195830422
49623	28	10	8435195830439
49624	35	5	8435195830446
49625	42	5	8435195830453
49626	54	1	8435195830460
49627	64	1	8435195830477
49628	67	1	8435195830484

ACCESORIOS DE COBRE

TAPÓN H

FIGURA 5301



Código	Medida	Caja	EAN
49516	10	10	8435195831092
49517	12	10	8435195831108
49518	14	10	8435195831115
49519	15	10	8435195831122
49520	16	10	8435195831139
49521	18	10	8435195831146
49522	22	10	8435195831153
49523	28	10	8435195831160
49524	35	5	8435195831177
49525	42	5	8435195831184
49526	54	5	8435195831191

CURVA 90° H-H

FIGURA 5002A



Código	Medida	Caja	EAN
49660	10	10	8435195830606
49661	12	10	8435195830613
49662	14	10	8435195830620
49663	15	10	8435195830637
49664	16	10	8435195830644
49665	18	10	8435195830651
49666	22	10	8435195830668
49667	28	10	8435195830675
49668	35	5	8435195830682
49669	42	5	8435195830699
49670	54	1	8435195830705
49671	64	1	8435195833799
49672	66,7	1	8435195833805
49673	76,1	1	8435195833812
49674	80	1	8435195833829

CURVA 90° M-H

FIGURA 5001A



Código	Medida	Caja	EAN
49643	10	10	8435195830491
49644	12	10	8435195830507
49645	14	10	8435195830514
49646	15	10	8435195830521
49647	16	10	8435195830538
49648	18	10	8435195830545
49649	22	10	8435195830552
49650	28	5	8435195830569
49651	35	5	8435195830576
49652	42	1	8435195830583
49653	54	1	8435195830590

ACCESORIOS DE COBRE

CURVA 45° H-H

FIGURA 5041



Código	Medida	Caja	EAN
49501	10	10	8435195830941
49502	12	10	8435195830958
49503	14	10	8435195830965
49504	15	10	8435195830972
49505	16	10	8435195830989
49506	18	10	8435195830996
49507	22	10	8435195831009
49508	28	10	8435195831016
49509	35	5	8435195831023
49510	42	5	8435195831030
49511	54	1	8435195831047
49512	64	1	8435195831054
49513	66,7	1	8435195831061
49514	76,1	1	8435195831078
49515	80	1	8435195831085

CURVA 45° M-H

FIGURA 5040



Código	Medida	Caja	EAN
49631	10	10	8435195830828
49632	12	10	8435195830835
49633	14	10	8435195830842
49634	15	10	8435195830859
49635	18	10	8435195830866
49636	22	10	8435195830873
49637	28	10	8435195830880
49638	35	5	8435195830897
49639	42	5	8435195830903
49640	54	1	8435195830910
49641	64	1	8435195830927
49642	67	1	8435195830934

CURVA DESVIACIÓN H-H

FIGURA 5085



Código	Medida	Caja	EAN
49688	12	10	8435195830712
49689	14	10	8435195830729
49690	15	10	8435195830736
49691	18	10	8435195830743
49692	22	10	8435195830750

CURVA DESVIACIÓN M-H

FIGURA 5086



Código	Medida	Caja	EAN
49680	12	10	8435195830767
49681	14	10	8435195830774
49682	15	10	8435195830781
49683	16	10	8435195830798
49684	18	10	8435195830804
49685	22	10	8435195830811

ACCESORIOS DE COBRE

TE RECTA H-H-H

FIGURA 5130



Código	Medida	Caja	EAN
49531	10	10	8435195831207
49532	12	10	8435195831214
49533	14	10	8435195831221
49534	15	10	8435195831238
49535	16	10	8435195831245
49536	18	10	8435195831252
49537	22	10	8435195831269
49538	28	10	8435195831276
49539	35	5	8435195831283
49540	42	5	8435195831290
49541	54	5	8435195831306
49542	64	1	8435195831313
49543	66,7	1	8435195831320
49544	76,1	1	8435195831337
49545	80	1	8435195831344
49546	108	1	8435195831351

TE REDUCIDA H-H-H

FIGURA 5130R



Código	Medida	Caja	EAN
49549	12 x 10 x 10	10	8435195831368
49550	12 x 14 x 12	10	8435195831375
49551	12 x 15 x 12	10	8435195831382
49552	14 x 12 x 12	10	8435195831399
49553	14 x 12 x 14	10	8435195831405
49554	14 x 14 x 12	10	8435195831412
49555	14 x 18 x 14	10	8435195839074
49557	15 x 12 x 12	10	8435195831429
49558	15 x 12 x 15	10	8435195831436
49559	15 x 15 x 12	10	8435195831443
49560	15 x 18 x 15	10	8435195831450
49561	15 x 22 x 15	10	8435195831467
49562	16 x 12 x 12	10	8435195831474
49563	16 x 12 x 14	10	8435195831481
49564	16 x 12 x 16	10	8435195831498
49565	16 x 14 x 12	10	8435195831504
49566	16 x 14 x 14	10	8435195831511
49567	16 x 14 x 16	10	8435195831528
49568	16 x 22 x 16	10	8435195839081
49569	18 x 12 x 12	10	8435195831535
49570	18 x 12 x 15	10	8435195831542
49571	18 x 12 x 16	10	8435195831559
49572	18 x 12 x 18	10	8435195831566
49573	18 x 14 x 14	10	8435195831573
49574	18 x 14 x 18	10	8435195831580
49575	18 x 15 x 12	10	8435195831597
49576	18 x 15 x 15	10	8435195831603
49577	18 x 15 x 18	10	8435195831610
49578	18 x 16 x 16	10	8435195831627
49579	18 x 16 x 18	10	8435195831634
49580	18 x 18 x 12	10	8435195831641
49581	18 x 18 x 14	10	8435195831658
49582	18 x 18 x 15	10	8435195831665

ACCESORIOS DE COBRE

TE REDUCIDA H-H-H

FIGURA 5130R

Código	Medida	Caja	EAN
49583	18 x 22 x 18	10	8435195831672
49584	18 x 28 x 18	10	8435195831689
49585	22 x 12 x 12	10	8435195831696
49586	22 x 12 x 22	10	8435195831702
49587	22 x 14 x 14	10	8435195831719
49588	22 x 14 x 22	10	8435195831726
49590	22 x 15 x 15	10	8435195831733
49591	22 x 15 x 18	10	8435195831740
49593	22 x 15 x 22	10	8435195831757
49594	22 x 16 x 16	10	8435195831764
49596	22 x 16 x 22	10	8435195831771
49597	22 x 18 x 15	10	8435195831788
49598	22 x 18 x 18	10	8435195831795
49599	22 x 18 x 22	10	8435195831801
49806	22 x 22 x 12	10	8435195831818
49807	22 x 22 x 15	10	8435195831825
49808	22 x 22 x 18	10	8435195831832
49809	22 x 28 x 22	10	8435195831849
49810	28 x 12 x 28	10	8435195831856
49811	28 x 15 x 15	10	8435195831863
49812	28 x 15 x 22	10	8435195831870
49813	28 x 15 x 28	10	8435195831887
49814	28 x 16 x 28	10	8435195831894
49815	28 x 18 x 15	10	8435195831900
49816	28 x 18 x 18	10	8435195831917
49817	28 x 18 x 22	10	8435195831924
49818	28 x 18 x 28	10	8435195831931
49819	28 x 22 x 15	10	8435195831948
49820	28 x 22 x 18	10	8435195831955
49821	28 x 22 x 22	10	8435195831962
49822	28 x 22 x 28	10	8435195831979
49823	28 x 28 x 15	10	8435195831986
49824	28 x 28 x 18	10	8435195831993
49825	28 x 28 x 22	10	8435195832006
49826	28 x 35 x 28	1	8435195832013
49831	35 x 15 x 35	1	8435195832020
49832	35 x 18 x 35	1	8435195832037
49589	35 x 22 x 35	1	8435195832044
49834	35 x 22 x 28	1	8435195832051
49835	35 x 28 x 22	1	8435195832068
49836	35 x 28 x 28	1	8435195832075
49837	35 x 28 x 35	1	8435195832082
49838	35 x 35 x 22	1	8435195832099
49839	35 x 35 x 28	1	8435195832105
49592	42 x 22 x 42	1	8435195832112
49840	42 x 28 x 42	1	8435195832129
49841	42 x 35 x 35	1	8435195832136
49842	42 x 35 x 42	1	8435195832143
49843	42 x 42 x 28	1	8435195832150
49595	54 x 22 x 54	1	8435195832167
49852	54 x 28 x 54	1	8435195832174
49853	54 x 35 x 54	1	8435195832181
49854	54 x 42 x 54	1	8435195832198
49851	64 x 42 x 64	1	8435195832204



CONDICIONES GENERALES DE VENTA

CATÁLOGO

Los precios indicados en este catálogo son los vigentes a fecha de su edición (Junio 2019) anulando tarifas, ofertas y precios especiales anteriores.

MEDITERRANEA DE VALVULAS se reserva el derecho de modificación en cualquier momento y sin previo aviso en caso de variación en sus condiciones de aprovisionamiento o fabricación.

En caso de estar interesado en que le notifiquemos cualquier modificación que se produzca en el mismo, deberá enviarnos un correo electrónico a nuestra dirección info@meval.es, indicando en el apartado "Asunto" la palabra "Altalista" y en el cuerpo la denominación del cliente que nos lo envía. De esta forma, entrará en una lista de correo interna, por la cual se le notificará cualquier variación que se produzca en nuestros productos, y muy especialmente, en nuestros precios.

Las imágenes mostradas en la tarifa son orientativas para facilitar la identificación de cada artículo, lo que no significa que la pieza a suministrar sea exactamente igual a la mostrada en la misma.

IMPUESTOS

En los precios de esta tarifa no va incluido el I.V.A. Cualquier otro tipo de impuesto será siempre a cargo del comprador.

PORTES

Para pedidos superiores a 300 euros netos, a cualquier destino de península y Baleares, se enviarán a portes pagados.

Para pedidos inferiores a 300 euros netos, se cargarán 9 euros en factura en concepto de portes o se enviará a portes debidos siempre que el comprador así lo indique.

Los pedidos con destinos Ceuta, Melilla y Canarias superiores a 1.200 € se enviaran a portes pagados.

La empresa no se hace cargo de las reexpediciones de recaderos o agencias locales, cuyos gastos irán a cargo del destinatario. No obstante, en el caso de que el pedido sea superior a 400 euros netos, la reexpedición sí irá a cargo de Meval.

Los pedidos con carácter urgente o que necesiten de otra agencia de transporte distinta a la que Meval tiene contratada, irán a cargo del comprador.

EMBALAJE

Todos los pedidos se enviarán libres de gastos de embalaje, siempre que el pedido se ajuste a los embalajes indicados en tarifa.

CONDICIONES DE VENTA

A convenir entre ambas partes.

CONDICIONES GENERALES DE VENTA

FORMA DE PAGO

El pago será efectuado en las condiciones pactadas con el comprador y en los plazos estipulados con el mismo.

GARANTÍA

Queda limitada exclusivamente al reemplazamiento del material reconocido como defectuoso por el personal técnico de Meval, sin indemnización.

En el caso de producirse un siniestro, MEDITERRANEA DE VALVULAS se hará responsable única y exclusivamente cuando el defecto sea de fabricación de nuestros productos. De ser así, es condición obligatoria que el damnificado dé parte a nuestra empresa en el momento del siniestro, para proceder a la activación del procedimiento de peritación. En caso contrario la empresa no se hará cargo de los daños ocasionados.

DEVOLUCIONES Y RECLAMACIONES

Únicamente se admitirán devoluciones y reclamaciones dentro de los 30 días de la fecha de recepción de la mercancía. En caso de devolución, siempre y cuando el material sea devuelto en las mismas condiciones que se envió.

Las devoluciones a portes debidos, solo se admitirán a través de la agencia que MEDITERRANEA DE VÁLVULAS determine.

COMPETENCIA JURÍDICA

Ambas partes se someten para cualquier litigio a los Juzgados y Tribunales de Valencia.

CLAÚSULA DE PROTECCION DE DATOS

Según lo Dispuesto por el Reglamento (UE) 2016/679 del Parlamento Europeo y del Consejo de 27 de abril de 2016 relativo a la protección de las personas físicas en lo que respecta al tratamiento de datos personales y a la libre circulación de estos datos, le informamos que tratamos la información que nos facilita con el fin de prestarles el servicio solicitado, realizar la facturación del mismo, y llevar las gestiones fiscales exigidas por Ley. Los datos proporcionados se conservaran mientras se mantenga la relación comercial o durante los años necesarios para cumplir con las obligaciones legales. Los datos no se cederán a terceros salvo en los casos en que exista una obligación legal. Usted tiene derecho a obtener confirmación sobre si en MEDITERRÁNEA DE VÁLVULAS, S.L. estamos tratando sus datos personales por tanto tiene derecho a ejercer los derechos de acceso, rectificación, limitación de tratamiento, supresión, portabilidad y oposición/revocación, en los términos que establece la normativa vigente en materia de protección de datos dirigiendo su petición a info@meval.es, asimismo, podrá dirigirse a la Autoridad de Control competente para presentar la reclamación que considere oportuna. Asimismo nos autoriza para ofrecerle productos y servicios relacionados con los solicitados y fidelizarle como cliente.



A series of horizontal dotted lines for writing, spanning the width of the page.



A series of horizontal dotted lines for writing, spanning the width of the page.



A series of horizontal dotted lines spanning the width of the page, intended for handwriting practice.



MEDITERRÁNEA DE VÁLVULAS, S.L.

Pol. Ind. Torrubero - Av. Constitución. 5 - 46136 MUSEROS (Valencia) España

Tel. 96 185 82 03 - Fax 96 185 83 90

info@meval.es - www.meval.es



TARIFA 2024

Mediterránea de Válvulas

VÁLIDO DESDE 10/10/2024





VÁLVULAS DE LATÓN

REF.	DESCRIPCIÓN	PVP	PÁG.
10001	VALVULA ESCUADRA EJE DE LATON 1/4 DE VUELTA 1/2*3/8	2,9900	10
10002	VALVULA ESCUADRA EJE DE LATON A-96 1/2*3/8	3,1000	10
10003	VALVULA ESCUADRA EJE DE LATON 1/4 DE VUELTA 1/2*1/2	3,7300	10
10004	VALVULA ESCUADRA EJE DE LATON A-96 1/2*1/2	3,7300	10
10005	VALVULA ESCUADRA EJE DE LATON A-96 CORTA M-H.3/8*3/8	3,2900	10
10006	VALVULA ESCUADRA EJE DE LATON A-96 CORTA M-H.3/8*1/2	3,3900	10
10007	VALVULA ESCUADRA ANTICAL 1/2 x 3/8	2,9000	10
10010	VALVULA ESCUADRA EJE LATON A-96 LARGA 1/2*3/8 - 86 mm	4,3000	11
10012	VALVULA ESCUADRA EJE DE LATON SUPER LARGA 1/2 x 3/8 - 96 mm	4,1000	11
12001	VALVULA ESCUADRA CON FILTRO AUTOLIMPIABLE 1/2*3/8	5,6200	11
12004	GRIFO LAVADORA CON FILTRO AUTOLIMPIABLE 1/2*3/4	5,9900	11
12101	VALVULA ESCUADRA 1/2 x3/8 MONTURA CERAMICA*CILINDRICA*	6,4000	11
12102	VALVULA ESCUADRA 1/2 x 1/2 MONTURA CERAMICA*CILINDRICA*	6,4500	11
12105	VALVULA ESCUADRA 1/2 x3/8 MONTURA CERAMICA*MINIMALISTA*	6,6000	11
12106	VALVULA ESCUADRA 1/2 x 1/2 MONTURA CERAMICA*MINIMALISTA*	6,8000	11
11002	GRIFO LAVADORA ESCUADRA A-96 EJE DE LATON 1/2*3/4	3,8900	12
11004	GRIFO LAVADORA ESCUADRA EJE DE LATON 1/2*3/4	3,3900	12
11006	GRIFO LAVADORA ESCUADRA EJE LATON 1/4 DE VUELTA 1/2*3/4	4,3500	12
11510	GRIFO LAVADORA RECTO EJE LATON 1/4 DE VUELTA 1/2*3/4	3,5800	12
11508	GRIFO LAVADORA CON VALVULA DE REGULACION 1/2 x 3/4 x 3/8	9,0500	13
11509	GRIFO LAVADORA CON VALVULA DE REGULACIÓN 1/2 x 1/2 x 3/8	11,3800	13
25517	GRIFO LAVADORA CON VALVULA DE ESCUADRA 1/2 X3/8 X 3/4	10,5000	13
12130	CODO LATON PULIDO Y CROMADO M1/2*M3/8	2,9000	14
12131	CODO LATON PULIDO Y CROMADO M1/2*M1/2	3,7900	14
63501	FLORON ACERO INOX 3/8 x 55 SIN GARRAS	0,2600	14
63502	FLORON ACERO INOX 1/2 x 55 SIN GARRAS	0,1500	14
63504	FLORON ACERO INOX 1/2 x 55 CON GARRAS	0,1800	14
63506	FLORON ACERO INOX 1/2 x 65 SIN GARRAS	0,4700	14
63508	FLORON ACERO INOX 3/4 x 65 SIN GARRAS	0,4700	14
63509	FLORON ACERO INOX 1/2 x 65 CON GARRAS	0,2900	14
64501	CODO MONOBLOC CROMO S/TUERCA 1/2*3/8	1,5800	14
71001	TUERCA ENLACE S/COLOR 3/8*11,2	0,4700	14
71002	TUERCA ENLACE S/COLOR 1/2*10	0,5900	14
71003	TUERCA ENLACE S/COLOR 1/2*12	0,6400	14
71004	TUERCA ENLACE NIQUELADA 3/8*11,2	0,7200	14
71005	TUERCA ENLACE NIQUELADA 1/2*10	0,6500	14
71006	TUERCA ENLACE NIQUELADA 1/2*12	0,7000	14
74002	BICONO CAUCHO 3/8*10	0,0870	14
74003	BICONO CAUCHO 1/2*12	0,0870	14
74004	BICONO CAUCHO 1/2x10	0,0870	14

GRIFERÍA TEMPORIZADA

REF.	DESCRIPCIÓN	PVP	PÁG.
1001	GRIFO LAVABO TEMPORIZADO CROMO 1/2 CON ATOMIZADOR	41,9500	16
1002	GRIFO LAVABO TEMPORIZADO MINIMALISTA CROMO 1/2	41,9500	16
1009	GRIFO LAVABO REPISA MEZCLADOR TEMPORIZADO CROMO	121,6200	16
1017	RECAMBIO GRIFO TEMPORIZADO (MONTURA Y PULSADOR) ART,1005-1009-1003	34,7000	16
1003	GRIFO PARED- FRONTAL TEMPORIZADO CROMO 1/2	55,9400	17
1012	RECAMBIO GRIFO TEMPORIZADO MONTURA CON PULSADOR-ART-1001	16,4000	17
1014	RECAMBIO GRIFO FUENTE MONTURA CON PULSADOR ART.1033	17,8400	17
1031	GRIFO PARED -FRONTAL TEMPORIZADO CROMO 1/2	25,5500	17
1033	GRIFO FUENTE VERTICAL TEMPORIZADO CROMO 3/8	52,6000	17



1034	GRIFO FUENTE VERTICAL CAÑO ALTO TEMPORIZADO CROMO 3/8	55,0700	17
1035	GRIFO FUENTE PUBLICA S/ COLOR 1/2	46,2000	18
1037	GRIFO FUENTE PUBLICA S/ COLOR 3/4	47,8500	18
1038	GRIFO FUENTE PUBLICA S/ COLOR 1"	59,2600	18
1047	GRIFO FUENTE PUBLICA CROMO 1/2	60,4800	18
1048	GRIFO FUENTE PUBLICA CROMO 3/4	66,0800	18
1049	GRIFO FUENTE PUBLICA CROMO 1"	98,2100	18
1126	GRIFO FUENTE PUBLICA PULSADOR FRONTAL S/COLOR 1/2	43,7800	18
1020	GRIFO DUCHA EMPOTRAR TEMPORIZADO 1/2	69,4700	19
1021	GRIFO DUCHA VISTO TEMPORIZADO CROMO 1/2	47,5000	19
1022	GRIFO DUCHA MEZCLADOR EMPOTRAR TEMPORIZADO	134,3600	19
1023	GRIFO DUCHA MEZCLADOR VISTO TEMPORIZADO	161,5000	19
1010	GRIFO PARED VISTO URINARIO TEMPORIZADO CROMO 1/2	40,9500	20
1011	RECAMBIO GRIFO URINARIO RECTO TUBO- FLORON	9,8900	20
1013	RECAMBIO GRIFO URINARIO MONTURA CON PULSADOR--ART,1010	17,1500	20
1016	GRIFO PARED VISTO URINARIO TEMPORIZADO CROMO 1/2 C-10	49,8000	20
1024	RECAMBIO URINARIO CURVO DE 15,5 cm CON TUERCA Y FLORON	13,8600	20
1050	GRIFO A PARED URINARIO TEMPORIZADO MINIMALISTA CROMO 1/2	37,7600	20
1057	PREMEZCLADOR PARA GRIFERIA TEMPORIZADA CON VALVULA ANTIRRETORNO 1/2	52,4100	20
1004	RECAMBIO MONTURA CON PULSADOR ART.1064	45,2000	21
1064	FLUXOMETRO EMPOTRAR CON PULSADOR 3/4	68,2000	21
1065	FLUXOMETRO VISTO CON PULSADOR CROMO 3/4	86,7800	21
1066	TUBO EN-L FLUXOMETRO REGULABLE CROMO 25*3/4	42,6800	21
1067	TUBO EN-L FLUXOMETRO REGULABLE CROMO 32*1"	43,7500	21
1075	FLUXOMETRO VISTO CON PULSADOR CROMO 1"	74,7500	21
85121	FILTRO REJILLA URINARIO	1,1900	21

GRIFOS DE PEDAL

REF.	DESCRIPCIÓN	PVP	PÁG.
1053	GRIFO MEZCLADOR UN PEDAL CROMO 1/2	94,2500	24
1055	GRIFO PEDAL SUELO 1 AGUA CROMO 1/2	71,9800	24
1082	GRIFO PEDAL SUELO-PARED 1 AGUA CROMO 1/2 TIPO LUX	133,1800	24
1040	CAÑO PARED FUNDIDO CROMO 1/2 CON ATOMIZADOR	41,8200	25
1041	CAÑO ENCIMERA FUNDIDO CROMO CON ATOMIZADOR	52,9100	25
1042	CAÑO ENCIMERA FUNDIDO GIRATORIO CROMO 1/2-CON ATOMIZADOR	84,8900	25
1043	CAÑO ENCIMERA TUBO GIRATORIO CROMO 1/2 CON ATOMIZADOR	46,2000	25
1044	CAÑO BAJO PARED TUBO GIRATORIO CROMO 1/2	44,8200	25
1045	CAÑO ALTO PARED TUBO GIRATORIO CROMO 1/2	41,5800	25
1054	CAÑO FUNDIDO ESPECIAL ENCIMERA CROMO 1/2	38,2500	25
1056	GRIFO MEZCLADOR DOS PEDALES A SUELO CROMO 1/2	179,2500	25
1083	GRIFO MEZCLADOR SUELO-PARED DOS PEDALES CROMO 1/2 TIPO LUX	198,3500	25

GRIFERÍA MEDICAL

REF.	DESCRIPCIÓN	PVP	PÁG.
25551	GRIFO PARED CAÑO BAJO GIRATORIO 1/2 PALANCA MEDICAL CROMO	108,7600	28
25552	GRIFO MONOMANDO REPISA PALANCA MEDICAL CROMO	49,7600	28
25555	GRIFO FRONTAL 1/2 PALANCA MEDICAL CROMO	47,5200	28
25556	GRIFO LAVABO 1/2 PALANCA MEDICAL CROMO	55,2500	28
1105	PALANCA GERONTOLOGICA-MEDICAL CROMO	14,0000	29
1110	CARTUCHO MONOMANDO ESTANDAR S/D 40 mm	3,9600	29
25553	GRIFO MONOMANDO PARED CAÑO BAJO PALANCA MEDICAL CROMO	89,2000	29
25557	GRIFO MONOMANDO LAVABO PALANCA MEDICAL CROMO	66,7800	29

GRIFERÍA SERIE			
REF.	DESCRIPCIÓN	PVP	PÁG.
1170	MONOMANDO LAVABO CROMO SERIE CATI	40,9800	32
1171	MONOMANDO BIDET CROMO SERIE CATI	40,6200	32
1172	MONOMANDO DUCHA CROMO SERIE CATI	49,9800	32
1173	MONOMANDO BAÑO CROMO SERIE CATI	59,4000	32
1201	MONOMANDO LAVABO NICE	38,0000	33
1202	MONOMANDO LAVABO EMPOTRAR NICE	99,0000	33
1203	MONOMANDO BIDET NICE	36,5000	33
1204	MONOMANDO DUCHA EMPOTRAR 1 VIA NICE	50,0000	33
1205	MONOMANDO DUCHA EMPOTRAR 2 VIAS NICE	76,5000	33
1206	MONOMANDO BAÑO CROMO SERIE NICE	65,1400	33
1207	MONOMANDO DUCHA CROMO SERIE NICE	54,1400	33
1180	MONOMANDO LAVABO MINIMALISTA CROMO	51,1000	34
1181	MONOMANDO BIDET MINIMALISTA CROMO	37,8000	34
1182	MONOMANDO BAÑO MINIMALISTA CROMO	85,6700	34
1183	MONOMANDO DUCHA MINIMALISTA CROMO	85,6700	34
1080	MONTURA CERAMICA GRIFO MONOBLOC SERIE ESFERA	7,5700	35
1084	MONOBLOC LAVABO CROMO SFERA	78,0000	35
1085	MONOBLOC BIDET CROMO SFERA	80,8500	35
1086	MONOBLOC BAÑO CROMO SFERA	118,8000	35
1087	MONOBLOC DUCHA CROMO SFERA	84,1500	35
1187	TERMOSTATICA DUCHA CONJUNTO CROMO	126,7500	36
1189	TERMOSTATICA BAÑO CONJUNTO CROMO	114,9600	36
11111	CARTUCHO TERMOSTATICO ART-1187-1189	70,5000	36
1301	GRIFO HIGIENICO MEZCLADOR WC/BIDET MANGO ABS	54,6000	37
1302	GRIFO HIGIENICO MEZCLADOR WC/BIDET MANGO LATÓN	68,2400	37
1303	MANGO ABS GRIFO HIGIENICO WC/BIDET	4,4000	37
1304	MANGO LATON GRIFO HIGIENICO WC/BIDET	21,5000	37
1305	FLEXO PVC GRIFO HIGIENICO 1,20 m	4,0800	37

COLUMNAS DE DUCHA			
REF.	DESCRIPCIÓN	PVP	PÁG.
78301	COLUMNA DE DUCHA STANDAR IRIS	133,0000	40
78302	COLUMNA DE DUCHA MONOMANDO IRIS CUADRADO	185,0000	40
78303	COLUMNA DE DUCHA CON MONOMANDO IRIS REDONDO	185,0000	40

GRIFERÍA DE FREGADERO			
REF.	DESCRIPCIÓN	PVP	PÁG.
1076	MONOMANDO FREGADERO VERTICAL CAÑO FUNDIDO	82,9500	42
1174	MONOMANDO FREGADERO HORIZONTAL CAÑO TUBO	39,7000	42
1175	MONOMANDO FREGADERO VERTICAL CAÑO TUBO	50,9500	42
1194	MONOMANDO FREGADERO VERTICAL CAÑO CISNE	58,2000	42
1112	CARTUCHO MONOMANDO ESTANDAR S/D 35 mm	3,9600	43
1177	MONOMANDO FREGADERO CROMO EXTRAIBLE CAÑO BAJO	75,9000	43
1179	MONOMANDO FREGADERO OSMOSIS	123,4300	43
1184	MONOMANDO FREGADERO VERTICAL MINIMALISTA	46,3000	43
1196	MONOMANDO FREGADERO EXTRAIBLE CROMO	93,8000	43
78005	MANGO DUCHA FREGADERO EXTRAIBLE	7,5000	43
1102	MONOMANDO FREGADERO PARED CAÑO ALTO FUNDIDO	97,8000	44
1176	MONOMANDO FREGADERO PARED CAÑO ALTO	65,4000	44
1178	MONOMANDO FREGADERO PARED CAÑO BAJO	57,6000	44



1135	MONTURA CERAMICA BATERIA DE FREGADERO	3,5500	45
19045	VOLANTE BATERIA FREGADERO METALICO CON TAPA E INDICE	4,4500	45
78204	CAÑO ALTO BATERIA FREGADERO CORTO	7,2000	45
78210	CAÑO ALTO BATERIA FREGADERO LARGO	4,9800	45
78211	CAÑO BAJO BATERIA FREGADERO	5,4500	45
99071	BATERIA FREGADERO 11cm CAÑO BAJO MONTURA CERAMICA	43,0000	45
99072	BATERIA FREGADERO 16 cm CAÑO BAJO MONTURA CERAMICA	45,0000	45
99073	BATERIA FREGADERO 11cm CAÑO LARGO CIERRE SOLETA	43,0000	45
99074	BATERIA FREGADERO 16 cm CAÑO LARGO CIERRE SOLETA	45,0000	45
99089	BATERIA FREGADERO 16 cm CAÑO LARGO MONTURA CERAMICA	47,0000	45
99090	BATERIA FREGADERO 11 cm CAÑO LARGO MONTURA CERAMICA	43,0000	45
99097	BATERIA FREGADERO 11 cm CAÑO CORTO MONTURA CERAMICA	43,0000	45
99098	BATERIA FREGADERO 16 cm CAÑO CORTO MONTURA CERAMICA	47,0000	45
1096	MONOBLOC FREGADERO CAÑO TUBO MONTURA CERAMICA	45,6200	46

GRIFERÍA DE UN AGUA

REF.	DESCRIPCIÓN	PVP	PÁG.
1074	CARTUCHO GRIFO UN AGUA ART.1094-1099-1103-1107	2,8000	48
1094	MONOMANDO MURAL 1 AGUA CAÑO ALTO	26,6800	48
1099	MONOMANDO 1 AGUA 1/2 GIRATORIO CAÑO ALTO 22 cm	24,3000	48
1103	MONOMANDO FREGADERO UN AGUA CAÑO VERTICAL CROMADO	40,6000	48
1107	MONOMANDO UN AGUA PARED CAÑO ALTO 1/2 CROMADO	35,7300	48
78216	CAÑO ALTO GRIFO 1 AGUA ARTICULO 1094	12,0000	48
1071	MONOMANDO LAVABO 1 AGUA REPISA CROMO PLUS	23,9500	49
1072	MONOMANDO LAVABO PARED 1 AGUA CROMO PLUS	22,9500	49
1078	CARTUCHO CERAMICO RECAMBIO 1071-1072	2,9200	49
1068	GRIFO 1 AGUA GIRATORIO MONTURA CERAMICA CAÑO BAJO 1/2	16,5500	50
1069	GRIFO 1 AGUA 1/2 GIRATORIO MONTURA CERAMICA CAÑO ALTO	17,2000	50
1098	MONOBLOC ENCIMERA CROMO MONTURA CERAMICA	25,2800	50
18510	MONTURA GRIFO MURAL ART.-1068-1069-1135	2,3000	50
78213	CAÑO GRIFO 1 AGUA ARTICULO 1069	4,9800	50
78215	CAÑO ART,1098 ALTO FREGADERA CROMO TUBO 18 x 260 mm	14,4000	50
1133	MONTURA SOLETA GRIFO-ART,25004-25006-25010-	2,9500	51
1134	MONTURA GRIFO LAVADORA CERAMICA -ART.25007-25008-25011	2,9500	51
25004	GRIFO LAVADORA SENCILLO 1/2*3/4 VOLANTE METAL	9,9500	51
25006	GRIFO LAVADORA DOBLE 1/2*3/4 VOLANTE METAL	14,6000	51
25007	GRIFO LAVADORA SENCILLO MONTURA CERAMICA 1/2*3/4 VOLANTE METAL	10,5000	51
25008	GRIFO LAVADORA DOBLE MONTURA CERAMICA 1/2*3/4 VOLANTE METAL	16,7000	51
25010	GRIFO LAVAVAJILLAS DOBLE 1/2*3/4 VOLANTE METAL	17,2800	51
25011	GRIFO LAVAVAJILLAS DOBLE MONTURA CERAMICA 1/2*3/4 VOLANTE METAL	15,9000	51
25526	GRIFO LAVADORA DOBLE*TIPO Y* 1/2*3/4*3/4 VOLANTE METALICO	11,8100	51
25507	CONJUNTO GRIFO ADAPTADOR 3/4 VOLANTE METAL	13,5400	52
25508	ALARGADERA ADAPTADOR GRIFO 3/4 CROMO	3,5200	52
25509	Y BIFURCACION SALIDA DOBLE M-3/4 LATON CROMO	11,9900	52
25519	PLACA ATORNILLAR M*H 1/2 CROMO	5,3200	52
25521	PLACA ATORNILLAR H*H 1/2 CROMO	6,3400	52
58535	Y-BIFURCACION CON TUERCA ABS Y JUNTA SILICONA 3/4	2,0600	52
79005	ATOMIZADOR M-22/100 CROMO(REPUESTO ART,24011)	0,7700	52
19020	MONTURA GRIFO ITALICO	2,9800	53
24003	GRIFO FRONTAL 1/2*14 VOLANTE METAL MONTURA CERAMICA	12,0000	53
24004	GRIFO FRONTAL 1/2*17 VOLANTE METAL MONTURA CERAMICA	13,0000	53
24005	GRIFO FRONTAL 1/2*14 VOLANTE METAL MONTURA SOLETA	12,0000	53
24006	GRIFO FRONTAL 1/2*17 VOLANTE METAL MONTURA SOLETA	12,0000	53
24007	GRIFO FRONTAL CON ATOMIZADOR 1/2 VOLANTE METAL	11,2700	53



25503	GRIFO ITALICO CROMO 1/2 CORTO VOLANTE METAL	14,3500	53
25504	GRIFO ITALICO CROMO 1/2 LARGO VOLANTE METAL	14,7000	53
24008	RECAMBIO MONTURA CERAMICA ART-24011	3,6800	54
24010	JUEGO GRIFOS BIDET 1/2 VOLANTE METAL	36,5000	54
24011	JUEGO GRIFOS LAVABO 1/2 VOLANTE METAL	27,2900	54

RECAMBIOS DE GRIFERÍA

REF.	DESCRIPCIÓN	PVP	PÁG.
1111	CARTUCHO MONOMANDO ESTANDAR C/D 40 mm	3,9600	56
1113	CARTUCHO MONOMANDO ESTANDAR C/D 35 mm	3,9600	56
78013	TUERCA PESTAÑA BATERIA 3/4 CROMO	1,6000	56
99095	PESTAÑA BATERIA S/COLOR	0,6800	56
99096	TUERCA CROMADA CAÑO BATERIA 3/4	1,6000	56

ACCESORIOS DE GRIFERÍA

REF.	DESCRIPCIÓN	PVP	PÁG.
1091	FIJACION GRIFERIA UN ESPARRAGO M-8 x 61 mm	1,0900	58
1092	FIJACION GRIFERIA DOS ESPARRAGOS M-6 x 60 mm	1,2000	58
1093	FIJACION GRIFERIA UN ESPARRAGO M-8 X 45 mm	0,8600	58
25510	JUEGO EXCENTRICAS 3/4*1/2*10 FLORON CROMO DE 65	6,4700	58
25511	JUEGO EXCENTRICAS 3/4*1/2*25 FLORON CROMO DE 85	13,5000	58
25523	JUEGO EXCENTRICAS 3/4*1/2*40 FLORON CROMO DE 100	16,7100	58
25524	CUERPO EXCENTRICA 1/2 *10 CROMO	2,4000	58
25525	CUERPO EXCENTRICA 1/2*25 CROMO	5,3000	58
25527	CUERPO EXCENTRICA 1/2*40 CROMO	6,2700	58
25530	FLORON EXCENTRICA CROMADO 3/4* 65	0,8800	58
25531	FLORON EXCENTRICA CROMADO GIGANTE 3/4*87	1,4400	58
25532	FLORON EXCENTRICA CROMADO SUPER GIGANTE 3/4*100	3,3700	58
50003	FLEXO INOX EPDM EXTENSIBLE FREGADERO M-3/8 -H 1/2 x 1,70-2,20 mts.	6,7200	59
50503	FLEXO INOX EPDM FREGADERO H-1/2*M-3/8 x 1,25 mts.	6,9500	59
50507	FLEXO INOX EPDM FREGADERO EXTRAIBLE H-1/2*M-15/100 x 1,25 mts.	6,9900	59
50510	PLOMADA GRIFO FREGADERO EXTRAIBLE	3,5400	59
56501	JUEGO CONEXION FLEXIBLE GRIFERIA M-10/100*H3/8 x30 cm	4,8500	59
56503	JUEGO CONEXION FLEXIBLE GRIFERIA M-10/100 *H-3/8 x 40 cm	5,1700	59
56504	JUEGO CONEXION FLEXIBLE GRIFERIA M-10/100 *H-3/8 x 50 cm	5,2500	59
79013	JUNTA ATOMIZADOR M*14 x 22 x 2*	0,0570	59
79017	JUNTA ATOMIZADOR H*14 x 21 x 2*	0,0460	59
79033	REPUESTO FILTRO Y REJILLA INTERIOR ATOMIZADOR H-22/100**M 24/100	0,2000	59
79039	INSERTO PARA ESPUMANTES M-24/100-H-22/100 PLASTICO	0,2700	59
1090	ENGANCHES MONOMANDO PORTACADENAS 21 x 5,5 cromo	0,1700	60
1120	INVERSOR MONOMANDO SERIE STANDAR	5,6400	60
1130	MONTURA CERAMICA GIRO 90 GRADOS -1/2	3,6500	60
1131	MONTURA CERAMICA GIRO 180 GRADOS -1/2	3,6500	60
1132	MONTURA GRIFERIA CONVENCIONAL 8 x 20 -1/2	3,8000	60
79001	ATOMIZADOR M-24/100 CROMO	0,7900	61
79002	ATOMIZADOR H-22/100 CROMO	0,8500	61
79003	ATOMIZADOR M-28/100 CROMO	1,1900	61
79004	ATOMIZADOR M-18/100 CROMO	1,8000	61
79006	ATOMIZADOR H-16/100 CROMO	1,5800	61
79007	ATOMIZADOR H 20/100 CROMO--REPUESTO ART 24007	0,9000	61
79010	ATOMIZADOR M-24/100 CROMO BLISTER	0,9500	61
79011	ATOMIZADOR H-22/100 CROMO BLISTER	0,9900	61
79012	ATOMIZADOR M-28/100 CROMO BLISTER	1,4000	61
79015	ATOMIZADOR ROTULA M-24/100 CROMO	2,8800	61



79016	ATOMIZADOR ROTULA H-22/100 CROMO	2,8800	61
79020	ATOMIZADOR M-24/100 ORO	1,3000	61
79021	ATOMIZADOR H-22/100 ORO	1,4100	61
79022	ATOMIZADOR M-28/100 ORO	1,7600	61
79023	ATOMIZADOR H-18/100 CROMO	0,9500	61
79024	ATOMIZADOR M-20/100 CROMO	0,9500	61
79025	ATOMIZADOR ROTULA M-24/100 ORO	4,4800	61
79026	ATOMIZADOR ROTULA.H-22/100 ORO	5,8800	61
79030	ATOMIZADOR M 24/100 CROMO *ECONOMIZADOR DE AGUA*	1,0500	61
79031	ATOMIZADOR H22/100 CROMO *ECONOMIZADOR DE AGUA*	0,9800	61
79032	LIMITADOR CAUDAL DUCHA 1/2 X 1/2 CROMO	2,2400	61
79035	ESPUMANTE FLEXIBLE CROMO H22/100 - M24/100 *INSERTO LATON*	6,3300	62
79036	ESPUMANTE FLEXIBLE CROMO H- 22/100 *CON INSERTO ABS*	4,7800	62
79038	ESPUMANTE FLEXIBLE CON ECONOMIZADOR DOS FUNCIONES	5,6300	62
79040	INSERTO PARA ESPUMANTES M-24/100-H-22/100 LATON	0,8000	62
79041	ECONOMIZADOR DOS FUNCIONES CON ROTULA ROSCA H-22/100	3,1000	62
79042	ECONOMIZADOR DOS FUNCIONES CON ROTULA ROSCA M-24/100	3,1000	62
79046	ADAPTADOR MANGUERA CROMO M 24/100 x M 3/4	1,9800	62
79047	ADAPTADOR MANGUERA CROMO H 22/100 x M 3/4	1,9800	62
79048	ADAPTADOR GRIFERIA ENCHUFE RAPIDO M-24/100	3,8900	62

COMPLEMENTOS DE BAÑO

REF.	DESCRIPCIÓN	PVP	PÁG.
75001	MANGO DUCHA C/CODO CRIS BLANCA	2,3200	64
75002	MANGO DUCHA C/CODO CRIS NEGRA	2,4600	64
75011	MANGO DUCHA S/CODO GOLF BLANCA	1,9300	64
76001	MANGO DUCHA C/CODO CROMO BOSTON BLANCA	3,2400	64
76002	MANGO DUCHA C/CODO CROMO BOSTON NEGRO	3,2400	64
77001	MANGO DUCHA FORMENTOR C/GAT.BLANCA	4,1600	64
77003	MANGO DUCHA FORMENTOR C/GAT.CROMO	5,5200	64
78001	MANGO DUCHA TER BLANCO CON CODO CROMADO	3,9500	64
78002	MANGO DUCHA TER NEGRO CON CODO CROMADO	3,1800	64
78003	MANGO DUCHA TER C/CODO CROMO	6,5000	64
78101	MANGO DUCHA ANTICAL BLANCA SIN CODO	3,9300	65
78102	MANGO DUCHA ANTICAL CROMO SIN CODO	3,4900	65
78103	MANGO DUCHA ANTICAL NEGRA SIN CODO	3,3200	65
78104	MANGO DUCHA ANTICAL CROMO 2 POSICIONES (EN CAJA)	5,9500	65
78105	MANGO DUCHA TOSCANA CROMO(en cajita)	6,3500	65
78106	MANGO DUCHA MINIMALISTA CROMO	5,7700	65
78111	MANGO DUCHA MINIMALISTA CUADRADO CROMO	9,4000	65
78112	MANGO DE DUCHA VIENA	6,9200	65
77002	CODO DUCHA LATON CROMO 1/2	5,1200	66
77005	CODO DUCHA CROMO ABS	0,9100	66
78107	MANGO DUCHA 5 POSICIONES CROMO(en cajita)	6,9700	66
78108	MANGO DUCHA PISA 4 POSICIONES CROMO	8,9900	66
78109	SETS DE DUCHA CLARA (ducha -soporte-flexo)en blister	12,5800	66
78113	MANGO DE DUCHA PALMA 5 POSICIONES	7,9000	66
50001	FLEXO INOX EPDM TUERCA GRAFILADA 1/2 x 1'5 mts.	3,4300	67
50002	FLEXO INOX EPDM TUERCA GRAFILADA 1/2 x 2mts.	4,2900	67
50501	FLEXO INOX EPDM TUERCA CONICA 1/2 x 1.5 mts.	4,7000	67
50502	FLEXO INOX EPDM TUERCA CONICA 1/2 x 2 mts.	5,9200	67
50504	FLEXO INOX DOBLE ENGATILLADO*EXTENSIBLE 1/2 x 1'70 / 2'40 mts.	7,8900	67
50508	FLEXO INOX EPDM TUERCA CONICA 1/2 x 1,75 mts.	4,9900	67
50513	FLEXO INOX EPDM TUERCA CONICA 1/2 x 1,20 mt	5,1900	67

52001	FLEXO DUCHA ESPIRAL BLANCO TUERCA CONICA CROMO 1/2 x 1,5 mts.	3,7800	67
52003	FLEXO DUCHA PVC TUERCA CONICA 1/2 x 1,5 mts.	2,5100	67
52004	FLEXO DUCHA PVC TUERCA CONICA 1/2 x 2 mts.	4,2600	67
78402	ROCIADOR DUCHA CROMO 1/2 x 60	2,1500	68
78403	ROCIADOR DUCHA PLASTICO 1/2 x 53	0,6500	68
78404	ROCIADOR DUCHA CROMO 1/2 x 80	2,8900	68
78407	ROCIADOR ANTIVANDALICO 1/2 R/PARED	39,7000	68
78408	ROCIADOR DUCHA ROTULA LATON CROMO ANTICAL CLARA	6,6000	68
78411	ROCIADOR DUCHA TRES POSICIONES CROMO CLARA	6,6000	68
79014	ROCIADOR DUCHA CON ROTULA CROMO 1/2	5,8100	68
79018	ROCIADOR DUCHA CON ROTULA LATON 1/2 x 43 mm	16,6400	68
78409	ROCIADOR DUCHA UNIVERSAL CROMO DE 200 mm	16,9000	69
78410	ROCIADOR DUCHA ESTRELLA CROMO	28,4000	69
78412	ROCIADOR DUCHA ABS CROMO CUADRADO 200 x 200 mm-(Espesor 1cm)	20,6500	69
78413	ROCIADOR DUCHA REDONDO ACERO INOX. 200 mm	18,7000	69
78414	ROCIADOR DUCHA CUADRADO ACERO INOX. 200 mm	18,7000	69
78201	BRAZO DUCHA LATON CROMO 1/2*250	6,8800	70
78202	BRAZO DUCHA LATON CROMO 1/2*300 mm.	8,1000	70
78205	BRAZO DUCHA LATON CROMO 1/2*400	9,2500	70
78206	BRAZO DUCHA FUNDIDO CROMO 1/2 x 15	8,4500	70
78207	BRAZO BATERIA MANANTIAL CROMO 1/2 x 37	13,6500	70
78208	BRAZO DUCHA TECHO 1/2*200 mm	7,1500	70
78209	BRAZO DUCHA LATON CURVO CON FLORON	3,3200	70
99235	BARRA DUCHA DESLIZANTE CON JABONERA CROMO	12,6700	70
78601	SOPORTE DUCHA GIRATORIO CONICO NEGRO	1,4800	71
78602	SOPORTE DUCHA GIRATORIO CONICO BLANCO	1,4900	71
78603	SOPORTE DUCHA GIRATORIO CONICO CROMO	2,6800	71
78604	SOPORTE DUCHA BAYONETA ABS CROMO	5,2400	71
78606	SOPORTE DUCHA BAYONETA ABS BLANCO	2,8600	71
78608	SOPORTE DUCHA ROTULA HORQUILLA CONICA METAL CROMO	10,3000	71
78609	SOPORTE DUCHA GIRATORIO LUNA CROMO	2,4000	71
78802	SOPORTE ROTULA DUCHA SIN TOMA METALICO CROMO	4,6800	71
78803	SOPORTE ROTULA DUCHA ABS CROMO	4,9100	71
78804	SOPORTE ROTULA DUCHA FLEXO TUERCA CONICA CROMO	2,1700	71
78805	SOPORTE ROTULA DUCHA SIN TOMA ABS BLANCO	1,2000	71
78806	SOPORTE DE DUCHA CROMO	1,9200	71
78807	CODO CON TOMA PARA FLEXO DE DUCHA M-1/2 X M-1/2 CROMO	11,7000	72
78808	SOPORTE CON TOMA PARA FLEXO DE DUCHA M-1/2 X M-1/2 CROMO	9,4300	72
78809	BARRA DE SEGURIDAD BAÑO-DUCHA 30 cm	25,5600	72
78810	BARRA DE SEGURIDAD BAÑO-DUCHA 40 cm	28,6500	72
78811	BARRA DE SEGURIDAD BAÑO-DUCHA 50 cm	39,3600	72

VÁLVULAS Y FILTROS DESAGÜE

REF.	DESCRIPCIÓN	PVP	PÁG.
25500	VALVULA DESAGUE LAVABO*CLICK-CLACK*1 1/4 METALICA	11,9500	74
25501	VALVULA DESAGUE LAVABO*CLICK-CLACK*1 1/4 METALICA TAPON REDONDO	14,9600	74
25502	VALVULA DESAGUE LAVABO*CLICK-CLACK*1 1/4 METALICA TAPON CUADRADO	15,6800	74
25528	JUNTA PLASTICO REBOSADERO VALVULA CLICK-CLACK	0,4000	74
25561	VALVULA DESAGUE LAVABO*CLICK-CLACK*1 1/4 ABS	5,8600	74
25513	VALVULA DESAGUE LAVABO*CLICK-CLACK*1 1/4 METALICA SIN REBOSADERO	10,3200	75
25515	VALVULA DESAGUE LAVABO*CLICK-CLACK*1 1/4 METALICA CON REBOSADERO	11,2000	75
25516	VALVULA DESAGUE BAÑERA *CLICK-CLACK* 1 1/2 METALICA	9,8900	75
25529	VALVULA DESAGUE BIDE *CLICK-CLACK* 1 1/4 METALICA TAPON REDONDO	14,9100	75
25512	VALVULA AUTOMATICA LATON CROMADO 1 1/4*COMPLETA CON VARILLAS*	14,1100	76



25579	VALVULA LAVABO-BIDET 1 1/4 x 70	4,2900	76
25580	VALVULA LAVABO-BIDET- 1 1/2 x 70	4,5200	76
44026	VALVULA AUTOMATICA LAVABO ABS 1 1/4	6,7000	76
85129	REJILLA FILTRO INOX PARA VALVULA DESAGUE 68 mm	1,3300	76
25514	CONJUNTO BAÑERA CON REBOSADERO HORIZONTAL - 1 1/2	10,3200	77
25563	CONJUNTO BAÑERA CON REBOSADERO SIFONICO -1 1/2	9,5900	77
25591	CONJUNTO BAÑERA CON REBOSADERO HORIZONTAL CLICK CLACK	22,7500	77
25595	VALVULA SIFONICA EXTRAPLANA PLATO DE DUCHA SIN EMBELLECEDOR	15,9800	77
25596	VALVULA SIFONICA EXTRAPLANA PLATO DUCHA CON EMBELLECEDOR CROMADO DE 120 mm	19,9000	77
25582	VALVULA PLATO DUCHA C/ORIFICIO 60 mm SALIDA HOR,REJILLA INOX	2,9400	78
25583	VALVULA SIFONICA PLATO DUCHA C/ORIFICIO 60 mm SALIDA HOR,REJILLA INOX	4,0900	78
25584	VALVULA SIFONICA PLATO DUCHA REJILLA DE 90 mm	6,9800	78
25585	VALVULA SIFONICA PLATO DUCHA C/ORIFICIO 90 mm EMBE,CHAMPIÑON DE 120 mm	16,4700	78
25586	VALVULA PLATO DUCHA C/ORIFICIO 60 mm REJILLA INOX 115 mm	6,5600	78
74501	ROSETA LAVABO-BIDE INOX CON ENGANCHE	1,5400	79
74502	ROSETA LAVABO-BIDE CIEGA BLANCA	0,4600	79
74503	ROSETA LAVABO-BIDET CIEGA CROMADA	0,6900	79
74505	EMBELLECEDOR LAVABO CROMO	0,4800	79
74506	TAPA ORIFICIOS CISTERNA TANQUE BAJO BLANCO 3/8	0,6700	79
74507	TAPA ORIFICIOS CISTERNA TANQUE BAJO CROMO 3/8	0,8900	79
85001	TAPON CAUCHO TAPA INOX DE 24	0,4800	79
85002	TAPON CAUCHO TAPA INOX DE 28	0,5900	79
85003	TAPON CAUCHO TAPA INOX DE 30	0,5900	79
85004	TAPON CAUCHO TAPA INOX DE 32	0,4900	79
85005	TAPON CAUCHO TAPA INOX DE 34	0,5800	79
85006	TAPON CAUCHO TAPA INOX DE 36	0,6300	79
85007	TAPON CAUCHO TAPA INOX DE 38	0,6400	79
85008	TAPON CAUCHO TAPA INOX DE 40	0,6600	79
85009	TAPON CAUCHO TAPA INOX DE 42	0,6600	79
85010	TAPON CAUCHO TAPA INOX DE 44	0,6900	79
85011	TAPON CAUCHO TAPA INOX DE 47	0,8100	79
85012	TAPON CAUCHO TAPA INOX DE 50	0,9200	79
85013	TAPON CAUCHO TAPA INOX DE 51	0,9400	79
85014	TAPON CAUCHO TAPA INOX DE 55	0,8900	79
85015	TAPON CAUCHO TAPA INOX DE 61	0,9900	79
85017	TAPON CAUCHO JIMTEN DE 46	0,7300	79
85101	ROLLO CADENA DE BOLAS CROMADA 3,2 mm * 50 m	54,5000	80
85102	ROLLO CADENA DE BOLAS CROMADA 3,8 mm * 50 m	68,5000	80
85103	CADENA DE BOLAS MONTADA 27 cm x 3,2 mm	0,6200	80
85104	CADENA DE BOLAS MONTADA 40 cm x 3,2 mm	0,7800	80
85105	CADENA DE BOLAS MONTADA 27 cm x 3,8 mm	0,7200	80
85106	CADENA DE BOLAS MONTADA 40 cm x 3,8 mm	1,2300	80
85110	ANILLA TRIANGULO PEQUEÑA	0,0400	80
85111	ANILLA LLAVERO 18 x 16 x 1 mm	0,1000	80
85112	ANILLA TRIANGULO GRANDE	0,0400	80
85113	ENGANCHE "U" CADENA DE 3,2 mm	0,0600	80
85114	ENGANCHE "U" CADENA DE 3,8 mm	0,0600	80
85115	ENGANCHE LLAVERO CADENA 3,2 TUBULAR	0,0800	80
85116	ENGANCHE LLAVERO CADENA 3,8 TUBULAR	0,0600	80
85117	ANILLA LLAVERO 16 x 14 x1 mm	0,0600	80
85130	FILTRO DESAGUE CAZOLETA FREG. O BAÑERA INOX 50 x 30	0,6900	82
85131	FILTRO DESAGUE CAZOLETA FREG. O BAÑERA INOX 65 x 40	0,8000	82
85132	FILTRO DESAGUE CAZOLETA FREG. O BAÑERA INOX 80 x 50	0,9500	82
85135	FILTRO DESAGUE FREG. O BAÑERA BLANCO 65 x 40	1,4300	82

85136	FILTRO DESAGUE FREG. O BAÑERA BLANCO 80 x 50	1,9500	82
85140	FILTRO DESAGUE CAZOLETA FERG.O BAÑERA CON PINZA	1,9900	82
85141	TAPON FREGADERO TIPO TEKA INOX 81x 31	2,9700	82
85142	TAPON CESTA TIPO TEKA BLANCO 7,60 x 31	2,8300	82
85143	TAPON CESTA INOX EJE CENTRAL LATON	3,9100	82

SIFONES DESAGÜE Y ACCESORIOS

REF.	DESCRIPCIÓN	PVP	PÁG.
63510	TUBO SIFON EXTENSIBLE TUERCA PVC 1"1/4 x 32	1,5900	84
63511	TUBO SIFON EXTENSIBLE TUERCA PVC 1"1/2 x 40	2,8700	84
63512	TUBO SIFON EXTENSIBLE TUERCA METAL 1"1/4 x 32	1,7600	84
63513	TUBO SIFON EXTENSIBLE TUERCA METAL 1"1/2 x 40	3,2500	84
63515	SIFON LAVABO LATON CROMADO S/VALVULA MINIMALISTA 1 1/4	48,5800	84
63518	TUBO SIFON EXTENSIBLE CROMADO 1 1/4 x 32	7,3000	84
63519	TUBO SIFON EXTENSIBLE CROMADO 1 1/2 x 40	7,3000	84
63520	SIFON BOTELLA LAVABO LATON CROMADO S/ VALVULA 1 1/4	16,8000	84
63523	ALARGADERA EXTENSIBLE SALIDA 32-40 PVC	2,1500	84
63524	ALARGADERA EXTENSIBLE SALIDA 32-40 CROMO	5,4400	84
63526	TUBO LATON CROMO ABOCARDADO CON PESTAÑA 32*20 CM.	3,7600	84
63528	TUBO LATON CROMO ABOCARDADO CON PESTAÑA 32*30 CM.	3,9900	84
63544	TUBO LATON CROMO SIN PESTAÑA 32*20 CM.	3,1200	84
63545	TUBO LATON CROMO SIN PESTAÑA 32*80 CM.	8,4000	84
25570	"Y" COMPACTO VALVULA LAVABO-BIDET SALIDA DE 40 mm	5,9100	85
25571	SIFON BOTELLA CORTO EXT. SALIDA HORI. DE 40 mm 1 1/4 x 70	7,4800	85
25572	SIFON BOTELLA EXTENSIBLE SALIDA HOR. DE 40 mm 1 1/2 x 70	6,2200	85
25573	SIFON CURVO EXTENSIBLE SALIDA HOR.DE 40 mm 1 1/2 x 70	6,5000	85
25574	SIFON BOTELLA EXTENSIBLE SALIDA HOR.DE 40mm CON RACOR 1 1/2	4,1200	85
25575	SIFON CURVO EXTENSIBLE SALIDA HOR. DE 40mm RACOR 1 1/2	4,3700	85
25576	SIFON CURVO DOBLE EXTENSIBLE SALIDA ORIENTABLE RACORES 1 1/2	10,7500	86
25577	SIFON CURVO EXTENSIBLE SALIDA HOR.DE 40 mm DOBLE RACOR 1 1/2	9,2600	86
25578	SIFON BOTELLA EXTENSIBLE SALIDA HOR. DE 40 mm DOBLE RACOR 1 1/2	9,4000	86
85025	SIFON DE GOMA ABIERTO 25 x 30 mm	2,8700	86
85026	SIFON DE GOMA ABIERTO 30 x 30 mm	4,9500	86
85027	SIFON DE GOMA ABIERTO 35 x 35 mm	4,9500	86
85028	SIFON DE GOMA CERRADO 25 x 30 mm	3,2600	86
85029	SIFON DE GOMA CERRADO 30 x 30 mm	5,4000	86
85030	SIFON DE GOMA CERRADO 35 x 35 mm	5,2000	86
85031	SIFON DOBLE COMPLETO CON TOMA PARA LAVAVAJILLAS	16,2800	86
85033	SIFON DE GOMA ABIERTO 35 x 40 mm	5,0500	86
85034	SIFON DE GOMA ABIERTO 40 x 40 mm	5,1500	86
85035	SIFON DE GOMA CERRADO 40 x 40 mm	5,3700	86
25518	VALVULA PVC PARA SIFON GOMA DE 30 mm	5,8500	87
25581	VALVULA FREGADERO 1 1/2 x 85	4,7800	87
25587	JUNTA CAUCHO CONICA SIFON ABS 1 1/4	0,4800	87
25589	JUNTA CAUCHO CONICA SIFON ABS 1 1/2	0,3800	87
63522	VALVULA SIFON BOTELLA BIDET-LAVABO 1 1/4	5,8500	87
63527	CONJUNTO TUERCA + GOMA CONICA + FLORON 3 UDS PARA TUBO SIFON CON PESTAÑA	4,2000	87
63532	VALVULA PVC PARA SIFON GOMA DE 35 mm	6,9900	87
63533	VALVULA PVC PARA SIFON GOMA DE 40 mm	3,9900	87
63546	FLORON ABS CROMADO SIFON DE 32	0,5500	87
63547	FLORON ABS CROMADO SIFON DE 40	0,7200	87
63548	FLORON ABS BLANCO SIFON DE 32	0,2900	87
63549	FLORON ABS BLANCO SIFON DE 40	0,2600	87



ENCHUFES DE GOMA			
REF.	DESCRIPCIÓN	PVP	PÁG.
85020	ENCHUFE INODORO GOMA PRESION VICTORIA 63mm* sin cuello	1,3900	90
85021	ENCHUFE INODORO GOMA BLANCA 25mm	1,1200	90
85022	ENCHUFE INODORO GOMA BLANCA 30mm	1,1200	90
85023	ENCHUFE INODORO GOMA PRESION LUCERNA 53 mm con cuello	1,3300	90
85024	ENCHUFE INODORO GOMA PRESION VICTORIA 63mm con cuello	1,5600	90
85032	BOYA ROYAL CON VARILLA DE LATON	1,8600	90
85038	ENCHUFE INODORO GOMA PRESION LUCERNA DE 53 sin cuello	1,3100	90
98024	GOMA ALIMENTADOR LUCERNA-VICTORIA	0,4500	90
99347	ENCHUFE INODORO GOMA LATEX 25mm	1,2800	90
99348	ENCHUFE INODORO GOMA LATEX 30 mm	1,2800	90

CABEZALES UNIVERSALES, ACCESORIOS Y RESPUESTOS			
REF.	DESCRIPCIÓN	PVP	PÁG.
40001	CABEZAL UNIVERSAL VISTO VOLANTE 3 PUNTAS METALICO 16/150	4,9400	92
40002	CABEZAL UNIVERSAL VISTO VOLANTE 3 PUNTAS METALICO 17/150	4,9400	92
40003	CABEZAL UNIVERSAL VISTO VOLANTE 3 PUNTAS METALICO 18/150	4,3800	92
40004	CABEZAL UNIVERSAL VISTO VOLANTE 3 PUNTAS METALICO 19/150	4,3800	92
40005	CABEZAL UNIVERSAL VISTO VOLANTE 3 PUNTAS METALICO 20/125	5,1000	92
40006	CABEZAL UNIVERSAL VISTO VOLANTE 3 PUNTAS METALICO 20/150	5,1000	92
40007	CABEZAL UNIVERSAL VISTO VOLANTE 3 PUNTAS METALICO 21/125	5,2700	92
40008	CABEZAL UNIVERSAL VISTO VOLANTE 3 PUNTAS METALICO 21/150	5,2700	92
40009	CABEZAL UNIVERSAL VISTO VOLANTE 3 PUNTAS METALICO 22/150	5,2700	92
40010	CABEZAL UNIVERSAL VISTO VOLANTE 3 PUNTAS METALICO 23/150	5,1800	92
40011	CABEZAL UNIVERSAL VISTO VOLANTE 3 PUNTAS METALICO 3/8	4,7000	92
40012	CABEZAL UNIVERSAL VISTO VOLANTE 3 PUNTAS METALICO 1/2	4,5500	92
40013	CABEZAL UNIVERSAL VISTO VOLANTE 3 PUNTAS METALICO 5/8	5,3300	92
40014	CABEZAL UNIVERSAL VISTO VOLANTE 3 PUNTAS METALICO 3/4	6,1700	92
40015	CABEZAL UNIVERSAL VISTO VOLANTE 3 PUNTAS METALICO 26/150	5,9900	92
41001	CABEZAL UNIVERSAL EMPOTRAR VOLANTE 3 PUNTAS METALICO 16/150	5,9800	92
41002	CABEZAL UNIVERSAL EMPOTRAR VOLANTE 3 PUNTAS METALICO 17/150	5,9800	92
41003	CABEZAL UNIVERSAL EMPOTRAR VOLANTE 3 PUNTAS METALICO 18/150	5,4000	92
41004	CABEZAL UNIVERSAL EMPOTRAR VOLANTE 3 PUNTAS METALICO 19/150	5,9800	92
41005	CABEZAL UNIVERSAL EMPOTRAR VOLANTE 3 PUNTAS METALICO 20/125	6,1500	92
41006	CABEZAL UNIVERSAL EMPOTRAR VOLANTE 3 PUNTAS METALICO 20/150	5,6100	92
41007	CABEZAL UNIVERSAL EMPOTRAR VOLANTE 3 PUNTAS METALICO 21/125	6,4000	92
41008	CABEZAL UNIVERSAL EMPOTRAR VOLANTE 3 PUNTAS METALICO 21/150	6,5000	92
41009	CABEZAL UNIVERSAL EMPOTRAR VOLANTE 3 PUNTAS METALICO 22/150	5,7000	92
41010	CABEZAL UNIVERSAL EMPOTRAR VOLANTE 3 PUNTAS METALICO 23/150	6,2300	92
41011	CABEZAL UNIVERSAL EMPOTRAR VOLANTE 3 PUNTAS METALICO 3/8	5,8200	92
41012	CABEZAL UNIVERSAL EMPOTRAR VOLANTE 3 PUNTAS METALICO 1/2	6,3800	92
41013	CABEZAL UNIVERSAL EMPOTRAR VOLANTE 3 PUNTAS METALICO 5/8	6,4100	92
41014	CABEZAL UNIVERSAL EMPOTRAR VOLANTE 3 PUNTAS METALICO 3/4	6,1200	92
41019	CABEZAL UNIVERSAL EMPOTRAR VOLANTE 3 P. METALICO 26/150	6,3400	92
42001	CABEZAL UNIVERSAL VISTO VOLANTE FACETADO METALICO 16/150	8,4800	93
42002	CABEZAL UNIVERSAL VISTO VOLANTE FACETADO METALICO 17/150	8,4800	93
42003	CABEZAL UNIVERSAL VISTO VOLANTE FACETADO METALICO 18/150	8,4800	93
42004	CABEZAL UNIVERSAL VISTO VOLANTE FACETADO METALICO 19/150	8,4800	93
42005	CABEZAL UNIVERSAL VISTO VOLANTE FACETADO METALICO 20/125	8,5800	93
42006	CABEZAL UNIVERSAL VISTO VOLANTE FACETADO METALICO 20/150	8,4800	93
42007	CABEZAL UNIVERSAL VISTO VOLANTE FACETADO METALICO 21/125	8,7800	93
42008	CABEZAL UNIVERSAL VISTO VOLANTE FACETADO METALICO 21/150	8,7800	93
42009	CABEZAL UNIVERSAL VISTO VOLANTE FACETADO METALICO 22/150	8,7800	93



42010	CABEZAL UNI.VERSAL VISTO VOLANTE FACETADO METALICO 23/150	8,7800	93
42011	CABEZAL UNIVERSAL VISTO VOLANTE FACETADO METALICO 3/8	8,4800	93
42012	CABEZAL UNIVERSAL VISTO VOLANTE FACETADO METALICO 1/2	8,7800	93
42013	CABEZAL UNIVERSAL VISTO VOLANTE FACETADO METALICO 5/8	8,7800	93
42014	CABEZAL UNIVERSAL VISTO VOLANTE FACETADO METALICO 3/4	8,9800	93
42015	CABEZAL UNIVERSAL VISTO VOLANTE FACETADO METALICO 26/150	8,9800	93
43001	CABEZAL UNIVERSAL EMPOTRAR VOLANTE FACETADO METALICO 16/150	9,2400	93
43002	CABEZAL UNIVERSAL EMPOTRAR VOLANTE FACETADO METALICO 17/150	9,2400	93
43003	CABEZAL UNIVERSAL EMPOTRAR VOLANTE FACETADO METALICO 18/150	9,2400	93
43004	CABEZAL UNIVERSAL EMPOTRAR VOLANTE FACETADO METALICO 19/150	9,2400	93
43005	CABEZAL UNIVERSAL EMPOTRAR VOLANTE FACETADO METALICO 20/125	9,5500	93
43006	CABEZAL UNIVERSAL EMPOTRAR VOLANTE FACETADO METALICO 20/150	9,5500	93
43007	CABEZAL UNIVERSAL EMPOTRAR VOLANTE FACETADO METALICO 21/125	9,7200	93
43008	CABEZAL UNIVERSAL EMPOTRAR VOLANTE FACETADO METALICO 21/150	9,7200	93
43009	CABEZAL UNIVERSAL EMPOTRAR VOLANTE FACETADO METALICO 22/150	9,7200	93
43010	CABEZAL UNIVERSAL EMPOTRAR VOLANTE FACETADO METALICO 23/150	9,7200	93
43011	CABEZAL UNIVERSAL EMPOTRAR VOLANTE FACETADO METALICO 3/8	9,2400	93
43012	CABEZAL UNIVERSAL EMPOTRAR VOLANTE FACETADO METALICO 1/2	9,7200	93
43013	CABEZAL UNIVERSAL EMPOTRAR VOLANTE FACETADO METALICO 5/8	9,7800	93
43014	CABEZAL UNIVERSAL EMPOTRAR VOLANTE FACETADO METALICO 3/4	9,7800	93
43019	CABEZAL UNIVERSAL EMPOTRAR VOLANTE FACETADO METALICO 26/150	9,7800	93
19062	MONTURA PRESION CON CRUZETA DE 17	7,2200	94
19063	MONTURA PRESION CON CRUZETA DE 18	7,8200	94
19065	MONTURA PRESION CON CRUZETA DE 20	6,8600	94
19067	MONTURA PRESION CON CRUZETA DE 22	14,2900	94
41015	PLACA MEDIDORA COMPROBACION ROSCAS MONTURAS	37,8600	94
41017	EXPOSITOR CABEZALES VISTOS Y EMPOTRAR	139,1200	94
43030	ARANDELA GRUPILLA LATON 5 m.m.	0,1200	94
83022	JUNTA TORICA NBR EJE CABEZAL VISTO-EMPOTRAR	0,0290	94
86001	ALARGADERA RECAMBIO CABEZALES 11 x 28 mm	0,5100	94
86002	ALARGADERA RECAMBIO CABEZALES 11 x 32 mm	0,5800	94
86003	ALARGADERA RECAMBIO CABEZALES 11 x 40 mm	0,7700	94
86004	ALARGADERA RECAMBIO CABEZALES 11 x 45 mm	0,9900	94
86005	ALARGADERA RECAMBIO CABEZALES 11 x 50 mm	1,0300	94
86006	ALARGADERA RECAMBIO CABEZALES 11 x 57 mm	1,1200	94
86007	ALARGADERA RECAMBIO CABEZALES 11 x 67 mm	1,4200	94
86008	ALARGADERA RECAMBIO CABEZALES 11 x 97 mm	2,6200	94
98083	EJE CABEZAL VISTO	0,6400	94
98084	EJE CABEZAL EMPOTRAR	0,8200	94
99179	VALVULA TRIANON	0,9800	94
19031	VOLANTE OCULTO METALICO CROMO	1,2800	95
19034	VOLANTE METALICO FACETADO CROMO CON TAPA E INDICES	4,9800	95
19035	VOLANTE TRES PUNTAS ABS CROMO	2,6200	95
19038	VOLANTE TRES PUNTAS METALICO ESTRIADO CROMO	2,1000	95
19041	VOLANTE OCULTO ABS CROMO	0,4900	95
19053	VOLANTE TRES PUNTAS METALICO CROMO CUADRADILLO 6,5 mm	2,3500	95
19030	ALARGADERA VALVULA EMPOTRAR M-H GRAFILADA C/TORNILLO	1,7000	96
19036	INDICE AZUL VOLANTE ABS	0,0350	96
19037	INDICE ROJO VOLANTE ABS	0,0350	96
19039	INDICE AZUL VOLANTE METALICO	0,0350	96
19040	INDICE ROJO VOLANTE METALICO	0,0350	96
19042	CASQUILLO CUBRE MONTURAS VALVULA CONTROL CROMO	0,2700	96
19043	FLORON ACERO INOX CABEZAL / VAL.EMPOTRAR	0,5500	96
29034	CASQUILLO DESLIZANTE FLORON VALVULA CONTROL	0,0850	96



98018	TORNILLO MANDO VALVULA CONTROL M 5 x 6	0,0400	96
--------------	--	--------	----

CONEXIONES FLEXIBLES			
REF.	DESCRIPCIÓN	PVP	PÁG.
55021	CONEX.FLEX.ACERO INOX M1/2H3/8x15 CM	1,6900	98
55022	CONEX.FLEX.ACERO INOX M1/2H3/8x20 CM	2,2500	98
55023	CONEX.FLEX.ACERO INOX M1/2H3/8x25 CM	1,9700	98
55024	CONEX.FLEX.ACERO INOX M1/2H3/8x30 CM	2,1100	98
55025	CONEX.FLEX.ACERO INOX M1/2H3/8x35 CM	2,9900	98
55026	CONEX.FLEX.ACERO INOX M1/2H3/8x40 CM	2,2000	98
55027	CONEX.FLEX.ACERO INOX M1/2H3/8x45 CM	2,2900	98
55028	CONEX.FLEX.ACERO INOX M1/2H3/8x50 CM	2,6900	98
55029	CONEX.FLEX. ACERO INOX M1/2H3/8x60 CM	2,9200	98
55030	CONEX. FLEX.ACERO INOX M1/2H 3/8x100 CM	3,7900	98
55521	CONEX.FLEX.ACERO INOX M3/8H1/2x15 CM	1,6900	98
55522	CONEX.FLEX.ACERO INOX M3/8H1/2x20 CM	1,7500	98
55523	CONEX.FLEX.ACERO INOX M3/8H1/2x25 CM	1,8900	98
55524	CONEX.FLEX.ACERO INOX M3/8H1/2x30 CM	2,2300	98
55525	CONEX.FLEX.ACERO INOX M3/8H1/2x35 CM	2,1000	98
55526	CONEX.FLEX.ACERO INOX M3/8H1/2x40 CM	2,2000	98
55527	CONEX.FLEX.ACERO INOX M3/8H1/2x45 CM	2,5200	98
55528	CONEX.FLEX.ACERO INOX M3/8 H1/2 x 50 CM	2,6800	98
55529	CONEXION FLEXIBLE ACERO INOX M3/8-H1/2 x 60 cm	2,9200	98
55530	CONEX.FLEX.ACERO INOX M3/8H1/2x100 CM	3,7900	98
56021	CONEX.FLEX.ACERO INOX M3/8H3/8x15 CM	1,7800	98
56022	CONEX.FLEX.ACERO INOX M3/8H3/8x20 CM	1,9500	98
56023	CONEX.FLEX.ACERO INOX M3/8H3/8x25 CM	1,9700	98
56024	CONEX.FLEX. ACERO INOX M3/8 H3/8 x 30 CM	2,1500	98
56025	CONEX.FLEX.ACERO INOX M3/8H3/8x35 CM	2,2500	98
56026	CONEX.FLEX.ACERO INOX M3/8H3/8x40 CM	2,3000	98
56027	CONEX.FLEX.ACERO INOX M3/8 H3/8 x 45 CM	2,5800	98
56028	CONEX.FLEX.ACERO INOX M3/8H3/8x50 CM	2,5000	98
56029	CONEX.FLEX.ACERO INOX M3/8-H3/8 x 60 cm	2,9500	98
56030	CONEX. FLEX. ACERO INOX M3/8-H3/8 x 100 cm	3,8600	98
56031	CONEX.FLEXI. ACERO INOX M3/8-H3/8 x 70 cm	3,7600	98
52521	CONEX.FLEX.ACERO INOX.H1/2H1/2x15 CM	1,8700	99
52522	CONEX.FLEX.ACERO INOX H1/2H1/2x20 CM	1,9400	99
52523	CONEX.FLEX.ACERO INOX.H1/2H1/2x25 CM	2,1500	99
52524	CONEX.FLEX.ACERO INOX H1/2H1/2x30 CM	2,2900	99
52525	CONEX.FLEX.ACERO INOX H1/2H1/2x35 CM	2,3900	99
52526	CONEX.FLEX.ACERO INOX H1/2H1/2x40 CM	2,4800	99
52527	CONEX.FLEX.ACERO INOX.H1/2H1/2x45 CM	2,2900	99
52528	CONEX.FLEX.ACERO INOX H1/2H1/2x50 CM	2,6700	99
52529	CONEX.FLEX.ACERO INOX H1/2H1/2x60 CM	2,9200	99
52530	CONEX.FLEX.ACERO INOX H1/2H1/2x100 CM	3,8900	99
52532	CONEX.FLEX.ACERO INOX H1/2H1/2 x 200 CM	12,1600	99
52533	CONEX.FLEX.ACERO INOX H1/2H1/2 x150 CM	7,2800	99
53010	CONEX.FLEX.ACERO INOX H3/8H3/8 x 200 CM	9,0400	99
53011	CONEX. FLEX,ACERO INOX H 3/8H3/8 x 150 cm	6,8200	99
53020	CONEX.FLEX.ACERO INOX H3/8H3/8x10 CM	1,9500	99
53021	CONEX.FLEX.ACERO INOX H3/8H3/8x15 CM	1,7100	99
53022	CONEX.FLEX.ACERO INOX H3/8H3/8x20 CM	1,8000	99
53023	CONEX.FLEX.ACERO INOX H3/8H3/8x25 CM	1,8900	99
53024	CONEX.FLEX.ACERO INOX H3/8 H3/8 x 30 CM	1,9900	99



53025	CONEX.FLEX.ACERO INOX H3/8H3/8x35 CM	1,9100	99
53026	CONEX.FLEX.ACERO INOX H3/8H3/8x40 CM	2,1800	99
53028	CONEX.FLEX.ACERO INOX H3/8H3/8x50 CM	2,3600	99
53029	CONEX.FLEX.ACERO INOX H3/8H3/8x60 CM	2,9800	99
53030	CONEX.FLEX.ACERO INOX H3/8H3/8x100 CM	3,8600	99
53031	CONEX.FLEX.ACERO INOX H3/8H3/8x70 CM	3,7000	99
53521	CONEX.FLEX.ACERO INOX H1/2H3/8x15 CM	1,6700	99
53522	CONEX.FLEX.ACERO INOX H1/2H3/8x20 CM	1,7800	99
53523	CONEX.FLEX.ACERO INOX H1/2H3/8x25 CM	2,1900	99
53524	CONEX.FLEX.ACERO INOX H1/2H3/8x30 CM	2,2500	99
53525	CONEX.FLEX.ACERO INOX H1/2H3/8x35 CM	2,3000	99
53526	CONEX.FLEX.ACERO INOX H1/2H3/8x40 CM	2,3400	99
53527	CONEX.FLEX.ACERO INOX H1/2H3/8x45 CM	2,2900	99
53528	CONEX.FLEX.ACERO INOX H1/2H3/8x50 CM	2,3900	99
53529	CONEX.FLEX.ACERO INOX H1/2H3/8x60 CM	2,9200	99
53530	CONEX.FLEX.ACERO INOX H1/2H3/8x100 CM	3,7900	99
54008	CONEX.FLEX.ACERO INOX M1/2 H1/2 x 200 CM	9,4000	99
54009	CONEX.FLEX.ACERO INOX M1/2 H1/2 x150 CM	7,4200	99
54021	CONEX.FLEX.ACERO INOX M1/2H1/2x15 CM	2,0700	99
54022	CONEX.FLEX.ACERO INOX M1/2H1/2x20 CM	2,1500	99
54023	CONEX.FLEX.ACERO INOX M1/2H1/2x25 CM	2,1500	99
54024	CONEX.FLEX.ACERO INOX M1/2H1/2x30 CM	2,3600	99
54025	CONEX.FLEX.ACERO INOX M1/2H1/2x35 CM	2,4500	99
54026	CONEX.FLEX.ACERO INOX M1/2H1/2x40 CM	2,5500	99
54027	CONEX.FLEX.ACERO INOX M1/2H1/2x45 CM	2,6500	99
54028	CONEX.FLEX.ACERO INOX M1/2H1/2x50 CM	2,7300	99
54029	CONEX.FLEX.ACERO INOX M1/2H1/2x60 CM	2,9200	99
54030	CONEX. FLEXI.ACERO INOX M1/2-H1/2 x 100 cm	3,7900	99
54031	CONEX. FLEX. ACERO INOX M1/2H1/2x70 CM	3,9600	99
56510	CONEXION ACERO INOX TERMO M-H-1/2 x 80 cm	7,4900	100
56511	CONEXION ACERO INOX TERMO M-H-1/2 x 15 cm	3,3900	100
56512	CONEXION ACERO INOX TERMO M-H-1/2 x 20 cm	4,3700	100
56513	CONEXION ACERO INOX TERMO M-H-1/2 x 25 cm	4,5500	100
56514	CONEXION ACERO INOX TERMO M-H-1/2 x 30 cm	4,8200	100
56515	CONEXION ACERO INOX TERMO M-H-1/2 x 35 cm	4,9800	100
56516	CONEXION ACERO INOX TERMO M-H-1/2 x 40 cm	5,2800	100
56517	CONEXION ACERO INOX TERMO M-H-1/2 x 45 cm	4,3500	100
56518	CONEXION ACERO INOX TERMO M-H-1/2 x 50 cm	5,7300	100
56519	CONEXION ACERO INOX TERMO M-H-1/2 x 60 cm	7,2800	100
56520	CONEXION ACERO INOX TERMO M-H-1/2 x 100 cm	8,8100	100
56521	CONEXION ACERO INOX TERMO H-H-1/2 x 15 cm	3,3900	100
56522	CONEXION ACERO INOX TERMO H-H-1/2 x 20 cm	3,6200	100
56523	CONEXION ACERO INOX TERMO H-H-1/2 x 25 cm	3,7900	100
56524	CONEXION ACERO INOX TERMO H-H-1/2 x 30 cm	4,4500	100
56525	CONEXION ACERO INOX TERMO H-H-1/2 x 35 cm	4,2000	100
56526	CONEXION ACERO INOX TERMO H-H-1/2 x 40 cm	5,1300	100
56527	CONEXION ACERO INOX TERMO H-H-1/2 x 45 cm	5,5000	100
56528	CONEXION ACERO INOX TERMO H-H-1/2 x 50 cm	5,2800	100
56529	CONEXION ACERO INOX TERMO H-H 1/2 x 60 cm	7,2800	100
56530	CONEXION ACERO INOX TERMO H-H-1/2 x 100 cm	8,8100	100
56531	CONEXION ACERO INOX TERMO M1/2-H3/4 x 15 cm	3,7600	100
56532	CONEXION ACERO INOX TERMO M1/2-H3/4 x 20 cm	3,9900	100
56533	CONEXION ACERO INOX TERMO M1/2-H3/4 x 25 cm	5,5400	100
56534	CONEXION ACERO INOX TERMO M1/2-H3/4 x 30 cm	4,5200	100



56535	CONEXION ACERO INOX TERMO M1/2-H3/4 x 35 cm	4,7300	100
56536	CONEXION ACERO INOX TERMO M1/2-H3/4 x 40 cm	4,9500	100
56537	CONEXION ACERO INOX TERMO M1/2-H3/4 x 45 cm	4,8000	100
56538	CONEXION ACERO INOX TERMO M1/2-H3/4 x 50 cm	5,8700	100
56539	CONEXION ACERO INOX TERMO M1/2-H3/4 x 60 cm	7,8000	100
56540	CONEXION ACERO INOX TERMO M1/2-H3/4 x 100 cm	8,9500	100
56541	CONEXION ACERO INOX TERMO H1/2-H3/4 x 15 cm	3,7600	101
56542	CONEXION ACERO INOX TERMO H1/2-H3/4 x 20 cm	3,9900	101
56543	CONEXION ACERO INOX TERMO H1/2-H3/4 x 25 cm	4,1600	101
56544	CONEXION ACERO INOX TERMO H1/2-H3/4 x 30 cm	4,5600	101
56545	CONEXION ACERO INOX TERMO H1/2-H3/4 x 35 cm	4,4800	101
56546	CONEXION ACERO INOX TERMO H1/2-H3/4 x 40 cm	5,0800	101
56547	CONEXION ACERO INOX TERMO H1/2-H3/4 x 45 cm	6,4000	101
56548	CONEXION ACERO INOX TERMO H1/2-H3/4 50 x cm	5,9800	101
56549	CONEXION ACERO INOX TERMO H1/2-H3/4 x 60 cm	7,8000	101
56550	CONEXION ACERO INOX TERMO H1/2-H3/4 x 100 cm	8,9500	101
56551	CONEXION ACERO INOX TERMO M-H-3/4 x 15 cm	3,7600	101
56552	CONEXION ACERO INOX TERMO M-H-3/4 x 20 cm	4,5900	101
56553	CONEXION ACERO INOX TERMO M-H-3/4 x 25 cm	4,9200	101
56554	CONEXION ACERO INOX TERMO M-H-3/4 x 30 cm	6,2700	101
56555	CONEXION ACERO INOX TERMO M-H-3/4 x 35 cm	5,2200	101
56556	CONEXION ACERO INOX TERMO M-H 3/4 x 40 cm	6,6900	101
56557	CONEXION ACERO INOX TERMO M-H-3/4 x 45 cm	6,9200	101
56558	CONEXION ACERO INOX TERMO M-H-3/4 x 50 cm	7,1300	101
56559	CONEXION ACERO INOX TERMO M-H-3/4 x 60 cm	7,8000	101
56560	CONEXION ACERO INOX TERMO M-H-3/4 x 100 cm	9,7800	101
56561	CONEXION ACERO INOX TERMO M3/4-H1/2 x 15 cm	3,7600	101
56562	CONEXION ACERO INOX TERMO M3/4-H1/2 x 20 cm	3,9900	101
56563	CONEXION ACERO INOX TERMO M3/4-H1/2 x 25 cm	4,1600	101
56564	CONEXION ACERO INOX TERMO M3/4-H1/2 x 30 cm	4,2900	101
56565	CONEXION ACERO INOX TERMO M3/4-H1/2 x 35 cm	4,4800	101
56566	CONEXION ACERO INOX TERMO M3/4-H1/2 x 40 cm	4,8700	101
56567	CONEXION ACERO INOX TERMO M3/4-H1/2 x 45 cm	4,8000	101
56568	CONEXION ACERO INOX TERMO M3/4-H1/2 x 50 cm	6,6700	101
56569	CONEXION ACERO INOX TERMO M3/4-H1/2 x 60 cm	7,8000	101
56570	CONEXION ACERO INOX TERMO M3/4-H1/2 x 100 cm	8,9500	101
56571	CONEXION ACERO INOX TERMO H-H-3/4 x 15 cm	3,7600	101
56572	CONEXION ACERO INOX TERMO H-H-3/4 x 20 cm	5,2300	101
56573	CONEXION ACERO INOX TERMO H-H 3/4 x 25 cm	5,7000	101
56574	CONEXION ACERO INOX TERMO H-H 3/4 x 30 cm	5,9200	101
56575	CONEXION ACERO INOX TERMO H-H-3/4 x 35 cm	6,1500	101
56576	CONEXION ACERO INOX TERMO H-H 3/4 x 40 cm	6,3800	101
56577	CONEXION ACERO INOX TERMO H-H 3/4 x 45 cm	6,5900	101
56578	CONEXION ACERO INOX TERMO H-H 3/4 x 50 cm	6,8300	101
56579	CONEXION ACERO INOX TERMO H-H-3/4 x 60 cm	7,8000	101
56580	CONEXION ACERO INOX TERMO H-H 3/4 x 100 cm	8,9500	101
56102	CONEXION BATERIAS DE CONTADOR M-H -3/4 x 30 cm	11,9200	102
56104	CONEXION BATERIAS DE CONTADOR M-H -3/4 x 40 cm	12,0800	102
56106	CONEXION BATERIAS DE CONTADOR M-H -3/4 x 50 cm	12,6500	102
56108	CONEXION BATERIAS DE CONTADOR M-H -3/4 x 60 cm	13,9500	102
56110	CONEXION BATERIAS DE CONTADOR M-H -3/4 x 80 cm	18,0100	102
56112	CONEXION BATERIAS DE CONTADOR M-H -3/4 x 100 cm	21,0500	102
56117	CONEXION BATERIAS DE CONTADOR M-H -1" x 30 cm	18,1200	102
56119	CONEXION BATERIAS DE CONTADOR M-H -1" x 40 cm	18,8800	102



56121	CONEXION BATERIAS DE CONTADOR M-H -1" x 50 cm	20,5500	102
56123	CONEXION BATERIAS DE CONTADOR M-H -1" x 60 cm	21,1900	102
56125	CONEXION BATERIAS DE CONTADOR M-H -1" x 80 cm	26,2900	102
56127	CONEXION BATERIAS DE CONTADOR M-H -1" x 100 cm	30,0600	102
56131	CONEXION BATERIAS DE CONTADOR M-H -1 1/4" x 30 cm	28,2400	102
56133	CONEXION BATERIAS DE CONTADOR M-H -1 1/4" x 40 cm	31,1200	102
56135	CONEXION BATERIAS DE CONTADOR M-H -1 1/4" x 50 cm	34,0500	102
56137	CONEXION BATERIAS DE CONTADOR M-H -1 1/4" x 60 cm	38,4300	102
56139	CONEXION BATERIAS DE CONTADOR M-H -1 1/4" x 80 cm	46,9600	102
56141	CONEXION BATERIAS DE CONTADOR M-H -1 1/4" x 100 cm	53,4400	102
50104	CONEXION BOMBA MALLA ACERO M-H 3/4 x 40 cm	12,4000	103
50106	CONEXION BOMBA MALLA ACERO M-H 3/4 x 50 cm	12,9500	103
50108	CONEXION BOMBA MALLA ACERO M-H 3/4 x 60 cm	14,6800	103
50116	CONEXION BOMBA MALLA ACERO H-H 3/4 x 40 cm	11,6000	103
50118	CONEXION BOMBA MALLA ACERO H-H 3/4 x 50 cm	12,9200	103
50120	CONEXION BOMBA MALLA ACERO H-H 3/4 x 60 cm	14,6000	103
50126	CONEXION BOMBA MALLA ACERO M-H 1" x 40 cm	20,1800	103
50128	CONEXION BOMBA MALLA ACERO M-H 1" x 50 cm	21,6400	103
50130	CONEXION BOMBA MALLA ACERO M-H 1" x 60 cm	22,9500	103
50137	CONEXION BOMBA MALLA ACERO H-H 1" x 40 cm	24,6000	103
50139	CONEXION BOMBA MALLA ACERO H-H 1" x 50 cm	26,2000	103
50140	CONEXION BOMBA MALLA ACERO H-H 1" x 60 cm	27,8000	103
50148	CONEXION BOMBA MALLA ACERO M-H 1 1/4 x 40 cm	32,6800	103
50150	CONEXION BOMBA MALLA ACERO M-H 1 1/4 x 50 cm	35,7000	103
50151	CONEXION BOMBA MALLA ACERO M-H 1 1/4 x 60 cm	50,2500	103
50163	CONEXION BOMBA MALLA ACERO H-H 1 1/4 x 40 cm	45,9900	104
50165	CONEXION BOMBA MALLA ACERO H-H 1 1/4 x 50 cm	50,5400	104
50167	CONEXION BOMBA MALLA ACERO H-H 1 1/4 x 60 cm	55,0500	104
50174	CONEXION BOMBA MALLA ACERO M-H 1 1/2 x 40 cm	61,8800	104
50176	CONEXION BOMBA MALLA ACERO M-H 1 1/2 x 50 cm	67,7200	104
50178	CONEXION BOMBA MALLA ACERO M-H 1 1/2 x 60 cm	73,5300	104
50188	CONEXION BOMBA MALLA ACERO H-H 1 1/2 x 40 cm	61,8800	104
50190	CONEXION BOMBA MALLA ACERO H-H 1 1/2 x 50 cm	67,7200	104
50192	CONEXION BOMBA MALLA ACERO H-H 1 1/2 x 60 cm	73,5300	104
50203	CONEXION BOMBA MALLA ACERO M-H 2" x 40 cm	79,6800	104
50205	CONEXION BOMBA MALLA ACERO M-H 2" x 50 cm	82,0800	104
50207	CONEXION BOMBA MALLA ACERO M-H 2" x 60 cm	85,5400	104
50218	CONEXION BOMBA MALLA ACERO H-H 2" x 40 cm	73,6900	104
50220	CONEXION BOMBA MALLA ACERO H-H 2" x 50 cm	79,1400	104
50222	CONEXION BOMBA MALLA ACERO H-H 2" x 60 cm	84,5800	104

CONEXIONES DE LAVADORA

REF.	DESCRIPCIÓN	PVP	PÁG.
52006	ENTRADA LAVADORA TUERCA NYLON 3/4 x 1.50 mts.	3,8000	106
52007	ENTRADA LAVADORA TUERCA NYLON 3/4 x 2 mts.	4,5700	106
52008	ENTRADA LAVADORA TUERCA METAL 3/4 x 1.5 mts.	4,9500	106
52009	ENTRADA LAVADORA TUERCA METAL 3/4 x 2 mts.	6,9400	106
52010	SALIDA AGUA LAVADORA 19/22 x 150 cm.	2,3000	106
52011	CURVA SALIDA LAVADORA	0,3300	106
52012	SALIDA AGUA LAVADORA 19/22 x 200 cm.	2,3900	106
52013	ENTRADA LAVADORA TUERCA METAL 3/4 x 3 mts.	7,6000	106
52014	ENTRADA LAVADORA TUERCA NYLON 3/4 x 3 mts.	7,2000	106
52015	SALIDA AGUA LAVADORA 19/22 x 300 cm.	3,9000	106
52017	SALIDA LAVADORA EXTENSIBLE-DE 0,60 a 1.75 mtros	3,7200	106



VÁLVULAS ESFERA EMPOTRAR Y ACCESORIOS

REF.	DESCRIPCIÓN	PVP	PÁG.
27015	VALVULA ESFERA EMPOTRAR SOLDAR 15*15	8,9800	108
27018	VALVULA ESFERA EMPOTRAR SOLDAR 18*18	7,2600	108
27022	VALVULA ESFERA EMPOTRAR SOLDAR 22*22	15,4000	108
27028	VALVULA ESFERA EMPOTRAR SOLDAR 28*28	12,6200	108
27503	VALVULA ESFERA EMPOTRAR ROSCAR H-H*1/2	6,3400	108
27504	VALVULA ESFERA EMPOTRAR ROSCAR H-H*3/4	7,8500	108
27505	VALVULA ESFERA EMPOTRAR ROSCAR H-H* 1"	12,6200	108
27616	VALVULA ESFERA EMPOTRAR MULTICAPA TUBO 16	7,4300	108
27620	VALVULA ESFERA EMPOTRAR MULTICAPA TUBO 20	8,0700	108
27625	VALVULA ESFERA EMPOTRAR MULTICAPA TUBO 25	8,9900	108
27632	VALVULA ESFERA EMPOTRAR MULTICAPA TUBO 32	13,1000	108
19032	ALARGADERA VALVULA EMPOTRAR CUADRADILLO M-H C/TORNILLO	1,5700	109
28001	MANDO Y FLORON VALVULA EMPOTRAR MERCURI	4,1500	109
29003	MANDO Y FLORON VALVULA EMPOTRAR ONDA	4,5800	109
29504	MANDO Y FLORON VALVULA EMPOTRAR OCULTO	2,9500	109
29506	MANDO Y FLORON VALVULA EMPOTRAR OCULTO CUADRADILLO 6,5 mm	2,4500	109

VÁLVULAS DE CONTROL

REF.	DESCRIPCIÓN	PVP	PÁG.
15015	VALVULA EMPOTRAR SOLDAR 15*15 VOLANTE ABS	9,2800	112
15018	VALVULA EMPOTRAR SOLDAR 18*18 VOLANTE ABS	9,6200	112
15022	VALVULA EMPOTRAR SOLDAR 22*22 VOLANTE ABS	9,9100	112
15028	VALVULA EMPOTRAR SOLDAR 28*28 VOLANTE ABS	18,6000	112
15122	VALVULA EMPOTRAR SOLDAR CUELLO CORTO 22*22 VOLANTE ABS	8,9200	112
15515	VALVULA EMPOTRAR SOLDAR 15*15 VOLANTE METALICO	8,2500	112
15518	VALVULA EMPOTRAR SOLDAR 18*18 VOLANTE METALICO	8,6200	112
15522	VALVULA EMPOTRAR SOLDAR 22*22 VOLANTE METALICO	8,9600	112
15528	VALVULA EMPOTRAR SOLDAR 28*28 VOLANTE METALICO	17,1000	112
15622	VALVULA EMPOTRAR SOLDAR CUELLO CORTO 22**22 VOLANTE METALICO	8,2800	112
16015	VALVULA EMPOTRAR SOLDAR 15*15 VOLANTE FACETADO	11,7400	112
16018	VALVULA EMPOTRAR SOLDAR 18*18 VOLANTE FACETADO	12,1700	112
16022	VALVULA EMPOTRAR SOLDAR 22** VOLANTE FACETADO	12,5100	112
16028	VALVULA EMPOTRAR SOLDAR 28*28 VOLANTE FACETADO	20,8900	112
16122	VALVULA EMPOTRAR SOLDAR CUELLO CORTO 22**22 VOLANTE FACETADO	11,4500	112
16515	VALVULA EMPOTRAR SOLDAR 15*15 VOLANTE OCULTO ABS	7,2500	112
16518	VALVULA EMPOTRAR SOLDAR 18*18 VOLANTE OCULTO ABS	7,5000	112
16522	VALVULA EMPOTRAR SOLDAR 22*22 VOLANTE OCULTO ABS	7,6500	112
16528	VALVULA EMPOTRAR SOLDAR 28*28 VOLANTE OCULTO ABS	15,2500	112
16622	VALVULA EMPOTRAR SOLDAR CUELLO CORTO 22**22 VOLANTE OCULTO ABS	6,5500	112
16715	VALVULA EMPOTRAR SOLDAR 15*15 VOLANTE OCULTO METALICO	8,2700	112
16718	VALVULA EMPOTRAR SOLDAR 18*18 VOLANTE OCULTO METALICO	8,5200	112
16722	VALVULA EMPOTRAR SOLDAR 22*22 VOLANTE OCULTO METALICO	8,6200	112
16728	VALVULA EMPOTRAR SOLDAR 28*28 VOLANTE OCULTO METALICO	16,6900	112
16822	VALVULA EMPOTRAR SOLDAR CUELLO CORTO 22*22 VOLANTE OCULTO METALICO	7,5500	112
17002	VALVULA EMPOTRAR ROSCAR 1/2*1/2 VOLANTE ABS	11,5000	113
17004	VALVULA EMPOTRAR ROSCAR 3/4*3/4 VOLANTE ABS	13,8000	113
17502	VALVULA EMPOTRAR ROSCAR 1/2*1/2 VOLANTE METALICO	11,3000	113
17504	VALVULA EMPOTRAR ROSCAR 3/4*3/4 VOLANTE METALICO	12,5500	113
18002	VALVULA EMPOTRAR ROSCAR 1/2*1/2 VOLANTE METALICO FACETADO	13,9000	113
18004	VALVULA EMPOTRAR ROSCAR 3/4*3/4 VOLANTE METALICO FACETADO	15,5000	113
18502	VALVULA EMPOTRAR ROSCAR 1/2*1/2 VOLANTE OCULTO ABS	9,5600	113



18504	VALVULA EMPOTRAR ROSCAR 3/4*3/4 VOLANTE OCULTO ABS	11,3500	113
18507	VALVULA DUCHA CUELLO CORTO 1/2*1/2 VOLANTE METALICO FACETADO	11,3400	113
18508	VALVULA DUCHA CUELLO LARGO 1/2*1/2 VOLANTE OCULTO METALICO	10,6000	113
18511	VALVULA DUCHA CUELLO CORTO 1/2*1/2 VOLANTE OCULTO METALICO	7,9500	113
18615	CUERPO VALVULA EMPOTRAR 15*15	3,3800	114
18618	CUERPO VALVULA EMPOTRAR 18*18	3,6900	114
18622	CUERPO VALVULA EMPOTRAR 22*22	3,7900	114
18628	CUERPO VALVULA EMPOTRAR 28*28	11,9800	114
18629	CUERPO VALVULA EMPOTRAR 1/2*1/2	5,5600	114
18630	CUERPO VALVULA EMPOTRAR 3/4*3/4	7,0700	114
18631	CUERPO VALVULA EMPOTRAR CUELLO CORTO 1/2*1/2	3,4500	114
19017	MONTURA VALVULA EMPOTRAR OCULTA 1/2"	3,5400	114
19022	CUERPO VALVULA EMPOTRAR CUELLO CORTO 22*22	2,9800	114
19023	MONTURA CABEZAL EMPOTRAR 19/150	3,4500	114
19024	MONTURA CABEZAL EMPOTRAR 22/150	3,7800	114
19025	MONTURA VALVULA EMPOTRAR OCULTA 19/150	3,3000	114
19026	MONTURA VALVULA EMPOTRAR OCULTA 22/150	3,5200	114
19028	MONTURA CABEZAL EMPOTRAR 1/2	3,6300	114

VÁLVULAS DE ESFERA

REF.	DESCRIPCIÓN	PVP	PÁG.
20003	VALVULA ESFERA POLIPROPILENO H*H 1/2	7,1900	118
20004	VALVULA ESFERA POLIPROPILENO H*H 3/4	9,4200	118
20005	VALVULA ESFERA POLIPROPILENO H*H 1"	17,0500	118
20006	VALVULA ESFERA POLIPROPILENO H*H 1"1/4	20,9500	118
20007	VALVULA ESFERA POLIPROPILENO H*H 1"1/2	31,8800	118
20008	VALVULA ESFERA POLIPROPILENO H*H 2"	46,1900	118
20011	VALVULA ESFERA H*H 1/4 MANDO PALANCA	4,7500	118
20012	VALVULA ESFERA H*H 3/8 MANDO PALANCA	3,5900	118
20013	VALVULA ESFERA H*H 1/2 MANDO PALANCA	5,5800	118
20014	VALVULA ESFERA H*H 3/4 MANDO PALANCA	7,3500	118
20015	VALVULA ESFERA H*H 1" MANDO PALANCA	12,2500	118
20016	VALVULA ESFERA H*H 1 1/4 MANDO PALANCA	15,8000	118
20017	VALVULA ESFERA H*H 1 1/2 MANDO PALANCA	25,0000	118
20018	VALVULA ESFERA H*H 2" MANDO PALANCA	41,9500	118
20019	VALVULA ESFERA H*H 2 1/2 MANDO PALANCA	99,7500	118
20020	VALVULA ESFERA H*H 3" MANDO PALANCA	139,7500	118
20021	VALVULA ESFERA H*H 4" MANDO PALANCA	139,7500	118
22005	VALVULA ESFERA M*H 3/8 MANDO PALANCA	3,9400	118
22006	VALVULA ESFERA M*H 1/2 MANDO PALANCA	5,1500	118
22007	VALVULA ESFERA M*H 3/4 MANDO PALANCA	7,1800	118
22008	VALVULA ESFERA M*H 1" MANDO PALANCA	9,8600	118
22115	VALVULA ESFERA SOLDAR 15*15 MANDO PALANCA	5,8000	118
22118	VALVULA ESFERA SOLDAR 18*18 MANDO PALANCA	6,9400	118
22122	VALVULA ESFERA SOLDAR 22*22 MANDO PALANCA	7,9800	118
22128	VALVULA ESFERA SOLDAR 28*28 MANDO PALANCA	16,9700	118
22135	VALVULA ESFERA SOLDAR 35*35 MANDO PALANCA	20,8800	118
22142	VALVULA ESFERA SOLDAR 42*42 MANDO PALANCA	33,7000	118
22154	VALVULA ESFERA SOLDAR 54*54 MANDO PALANCA	54,7200	118
22508	VALVULA ESFERA M*M 1/2 MANDO PALANCA	7,2500	118
22509	VALVULA ESFERA M*M 3/4 MANDO PALANCA	8,2500	118
22510	VALVULA ESFERA M*M 1" MANDO PALANCA	13,9100	118
22524	VALVULA ESFERA M*M 3/8 MANDO PALANCA	5,2600	118
22601	VALVULA ESFERA ESCUADRA M*H 1/2 MANDO CUADRADILLO*MALLORCA*	7,6800	119



22602	VALVULA ESFERA ESCUADRA M*M 1/2 MANDO CUADRADILLO*MALLORCA*	7,6900	119
22603	VALVULA ESFERA H*H 1/2 MANDO CUADRADILLO *MALLORCA*	6,2000	119
22604	VALVULA ESFERA H*H 3/4 MANDO CUADRADILLO*MALLORCA	8,2200	119
22605	VALVULA ESFERA H*H 1" MANDO CUADRADILLO*MALLORCA*	12,9500	119
22606	VALVULA ESFERA H*H 1 1/4 MANDO CUADRADILLO*MALLORCA*	19,3000	119
22607	VALVULA ESFERA H*H 1 1/2 MANDO CUADRADILLO*MALLORCA*	29,7200	119
22608	VALVULA ESFERA H*H 2" MANDO CUADRADILLO*MALLORCA*	42,1600	119
22612	VALVULA ESFERA M*H 1/2 MANDO CUADRADILLO*MALLORCA*	4,9500	119
22613	VALVULA ESFERA M*H 3/4 MANDO CUADRADILLO*MALLORCA*	6,8500	119
22614	VALVULA ESFERA M*H 1" MANDO CUADRADILLO*MALLORCA*	10,1200	119
22621	VALVULA ESFERA H*H 1/2 MANDO CUADRADILLO DE 18	7,3100	119
22622	VALVULA ESFERA H*H 3/4 MANDO CUADRADILLO DE 18	9,7600	119
22623	VALVULA ESFERA H*H 1" MANDO CUADRADILLO DE 18	20,9800	119
22624	VALVULA ESFERA H*H 1 1/4 MANDO CUADRADILLO DE 25	24,9300	119
22625	VALVULA ESFERA H*H 1 1/2 MANDO CUADRADILLO DE 25	35,4300	119
22626	VALVULA ESFERA H*H 2" MANDO CUADRADILLO DE 25	57,3200	119
22627	VALVULA ESFERA H*H 2"1/2 MANDO CUADRADILLO DE 26	109,1000	119
22628	VALVULA ESFERA H*H 3" MANDO CUADRADILLO DE 26	162,4400	119
22629	VALVULA ESFERA H*H 4" MANDO CUADRADILLO DE 26	271,3000	119
22630	VALVULA ESFERA M*H 1/2 MANDO CUADRADILLO DE 18	5,6000	119
22631	VALVULA ESFERA M*H 3/4 MANDO CUADRADILLO DE 18	8,6000	119
22632	VALVULA ESFERA M*H 1" MANDO CUADRADILLO DE 18	12,5300	119
20501	VALVULA ESFERA H*H 1/4 MANDO PALOMILLA	4,5800	120
20502	VALVULA ESFERA H*H 3/8 MANDO PALOMILLA	3,8400	120
20503	VALVULA ESFERA H*H 1/2 MANDO PALOMILLA	4,6500	120
20504	VALVULA ESFERA H*H 3/4 MANDO PALOMILLA	7,1800	120
20505	VALVULA ESFERA H*H 1" MANDO PALOMILLA	10,9300	120
22501	VALVULA ESFERA M*H 1/4 MANDO PALOMILLA	6,5500	120
22502	VALVULA ESFERA M*H 3/8 MANDO PALOMILLA	4,4500	120
22503	VALVULA ESFERA M*H 1/2 MANDO PALOMILLA	5,6000	120
22504	VALVULA ESFERA M*H 3/4 MANDO PALOMILLA	8,5700	120
22505	VALVULA ESFERA M*H 1" MANDO PALOMILLA	12,5900	120
22506	VALVULA ESFERA ESCUADRA M*H 1/2 MANDO PALOMILLA	10,8800	120
22507	VALVULA ESFERA ESCUADRA M*M 1/2 MANDO PALOMILLA	6,9100	120
22511	VALVULA ESFERA M*M 1/2 MANDO PALOMILLA	5,3500	120
22512	VALVULA ESFERA M*M 3/4 MANDO PALOMILLA	8,2500	120
22515	VALVULA ESFERA SOLDAR 15*15 MANDO PALOMILLA	4,1900	120
22517	VALVULA ESFERA M*M 1" MANDO PALOMILLA	13,3600	120
22518	VALVULA ESFERA SOLDAR 18*18 MANDO PALOMILLA	4,2200	120
22522	VALVULA ESFERA SOLDAR 22*22 MANDO PALOMILLA	7,4200	120
23001	VALVULA ESFERA MINI H*H 1/4 MANDO PALANCA	5,0700	121
23002	VALVULA ESFERA MINI H*H 3/8 MANDO PALANCA	4,1500	121
23003	VALVULA ESFERA MINI H*H 1/2 MANDO PALANCA	3,7100	121
23004	VALVULA ESFERA MINI H*H 3/4 MANDO PALANCA	8,5800	121
23501	VALVULA ESFERA MINI M*H 1/4 MANDO PALANCA	3,4300	121
23502	VALVULA ESFERA MINI M*H 3/8 MANDO PALANCA	3,3000	121
23503	VALVULA ESFERA MINI M*H 1/2 MANDO PALANCA	3,8900	121
23504	VALVULA ESFERA MINI M*H 3/4 MANDO PALANCA	5,9900	121

GRIFOS CURVOS Y ACCESORIOS

REF.	DESCRIPCIÓN	PVP	PÁG.
24506	GRIFO CURVO 1/2*3/4 MANDO PALANCA	5,4300	124
24507	GRIFO CURVO 3/4*1" MANDO PALANCA	7,6400	124
24508	GRIFO CURVO 1"*1"1/4 MANDO PALANCA	13,0000	124

24509	GRIFO CURVO ESFERA SALIDA DOBLE 1/2 *3/4 *1/2 MANDO PALANCA	11,9800	124
24519	GRIFO CURVO 3/4*3/4 MANDO PALANCA	10,9900	124
24522	GRIFO CURVO 1/2*3/4 ENCHUFE RAPIDO MANDO PALANCA	7,2500	124
24523	GRIFO CURVO 3/4*1" ENCHUFE RAPIDO MANDO PALANCA	10,5900	124
24524	GRIFO CURVO 1" * 1" 1/4 ENCHUFE RAPIDO MANDO PALANCA	18,5000	124
24528	GRIFO CURVO 1" * 1" MANDO PALANCA	17,2000	124
24500	GRIFO CURVO ANTIHIELO NORDICO 1/2 *3/4 MANDO PALANCA	15,4500	125
24501	GRIFO CURVO ANTIHIELO NORDICO 3/4 *1" MANDO PALANCA	23,5500	125
24502	GRIFO CURVO ANTIHIELO NORDICO 1" *1 1/4 MANDO PALANCA	34,3200	125
24503	GRIFO CURVO POLIPROPILENO 1/2*3/4 MANDO PALANCA	11,6900	125
24504	GRIFO CURVO POLIPROPILENO 3/4*1" MANDO PALANCA	20,9500	125
24505	GRIFO CURVO POLIPROPILENO 1"*1"1/4 MANDO PALANCA	27,7500	125
24525	GRIFO CURVO 1/2*3/4 PARA CANDADO MANDO PALANCA	7,1800	125
24541	RACOR ADAPTABLE A ENCHUFE RAPIDO SU COLOR H-3/4	2,1700	126
24544	RACOR ADAPTABLE A ENCHUFE RAPIDO NIQUEL H-3/4	2,3900	126
24545	RACOR ADAPTABLE A ENCHUFE RAPIDO NIQUEL H-1"	4,2500	126
24546	ENCHUFE RAPIDO ADAPTABLE A MANGUERA SU COLOR-1/2	9,7000	126
24547	ENCHUFE RAPIDO ADAPTABLE A MANGUERA SU COLOR-3/4	13,2600	126
24549	UNION ADAPTABLE MANGUERA-MANGUERA SU COLOR-1/2	7,5700	126
24550	UNION ADAPTABLE MANGUERA-MANGUERA SU COLOR-3/4	16,7200	126
24553	BOQUILLA GRADUABLE REG.DE CAUDAL EN SALIDA ADAPTABLE AL ENCHUFE RAPIDO	10,6300	126
71504	RACOR MANGUERA DOS PIEZAS GRIFO 3/4 x 15	0,9800	126
71505	RACOR MANGUERA DOS PIEZAS GRIFO 3/4 x 1" x 20,5	1,7900	126
71506	RACOR MANGUERA 2 PIEZAS GRIFO 1"*1 1/4	4,7100	126
71507	RACOR MANGUERA DOS PIEZAS GRIFO 1" x 26,5	2,9700	126

GRIFOS DECORATIVOS

REF.	DESCRIPCIÓN	PVP	PÁG.
1125	GRIFO FUENTE PUBLICA CIERRE MONTURA S/COLOR 1/2	45,8500	128
24531	GRIFO JARDIN DECORADO RENACIMIENTO*1/2	38,6800	128
24532	GRIFO JARDIN DECORADO PATO*1/2	36,7500	128
24533	GRIFO JARDIN DECORADO PAJARO*1/2	36,7500	128
24534	GRIFO JARDIN DECORADO RANA*1/2	36,7500	128
24535	GRIFO JARDIN DECORADO PEZ*1/2	36,7500	128
24536	GRIFO JARDIN DECORADO GALLO*1/2	33,8000	128
24510	GRIFO CODILLO PULIDO SIN RACOR 1/2	6,9200	129
24512	GRIFO CODILLO PULIDO SIN RACOR 3/4	7,2500	129
24513	GRIFO CODILLO CROMO SIN RACOR 1/2	6,9100	129
24514	GRIFO CODILLO CROMO SIN RACOR 3/4	7,6400	129
24515	GRIFO CODILLO PULIDO CON TUERCA Y RACOR 1/2	9,9400	129
24516	GRIFO CODILLO PULIDO CON TUERCA Y RACOR 3/4	9,9800	129
24517	GRIFO CODILLO CROMO CON TUERCA Y RACOR 1/2	9,4300	129
24518	GRIFO CODILLO CROMO CON TUERCA Y RACOR 3/4	22,7000	129
24520	GRIFO BARRIL CON CANULA SIN TUERCA *SU COLOR*	2,5200	129
24521	GRIFO BARRIL SIN CANULA CON TUERCA *SU COLOR*	2,2800	129
24526	GRIFO CODILLO PULIDO CON TUERCA Y RACOR 3/4 x 1"	14,7000	129

REDUCTORES DE PRESIÓN Y MANÓMETROS

REF.	DESCRIPCIÓN	PVP	PÁG.
25601	REDUCTOR DE PRESION CON RACORES H*H 1/2	44,2500	132
25602	REDUCTOR DE PRESION CON RACORES H*H 3/4	75,3800	132
25603	REDUCTOR DE PRESION CON RACORES H*H 1"	77,0000	132
25604	REDUCTOR DE PRESION CON RACORES H*H 1 1/4	147,0000	132
25605	REDUCTOR DE PRESION CON RACORES H*H 1 1/2	165,0000	132



25606	REDUCTOR DE PRESION CON RACORES H*H 2"	259,0000	132
25607	REDUCTOR DE PRESION H*H 2 1/2	276,2500	132
25608	REDUCTOR DE PRESION H*H 3"	347,3200	132
25610	REDUCTOR DE PRESION PARA CALENTADORES H*H 1/2 PN16	20,7700	132
25612	REDUCTOR DE PRESION CON RACORES M-M 3/4 NIQUEL	55,6400	132
25615	REDUCTOR DE PRESION S/ COLOR H*H 3/4	52,8000	132
25630	REDUCTOR DE PRESION NIQUEL H*H 3/4 PN16	21,7800	132
25631	REDUCTOR DE PRESION S/COLOR H*H 1"	62,6500	132
25632	REDUCTOR DE PRESION S/COLOR H*H 1"1/4	120,2500	132
25633	REDUCTOR DE PRESION S/COLOR H*H 1"1/2	130,3500	132
25634	REDUCTOR DE PRESION S/COLOR H*H 2"	198,2500	132
25611	DISPOSITIVO ANTI-GOLPE DE ARIETE 1/2	21,9600	133
25702	MANOMETRO SALIDA INFERIOR 1/4*53 -BAR 0-6	6,2700	133
25703	MANOMETRO SALIDA INFERIOR 1/4*53 -BAR 0-10	6,6500	133
25704	MANOMETRO SALIDA INFERIOR 1/4*53-BAR 0-16	6,4000	133
25712	MANOMETRO SALIDA POSTERIOR 1/4*53 -BAR 0-6	6,6100	133
25713	MANOMETRO SALIDA POSTERIOR 1/4*53 -BAR 0-10	7,6000	133
25725	MANOMETRO SALIDA INFERIOR 1/4 *63 -BAR 0-6 CON GLICERINA	13,4900	133
25726	MANOMETRO SALIDA INFERIOR 1/4 *63 -BAR 0-10 CON GLICERINA	11,8600	133
25727	MANOMETRO SALIDA INFERIOR 1/2 *100 -BAR 0-10 CON GLICERINA	23,9300	133
25728	MANOMETRO SALIDA INFERIOR 1/2*100-BAR 0-40 CON GLICERINA	28,0100	133
25729	MANOMETRO SALIDA INFERIOR 1/4*63-BAR 0-60 CON GLICERINA	11,8300	133
25730	MANOMETRO SALIDA INFERIOR 1/4 * 63-BAR 0-40 CON GLICERINA	15,5700	133
25742	MANOMETRO SALIDA POSTERIOR 1/4*63 -BAR 0-6 CON GLICERINA	12,5500	133
25743	MANOMETRO SALIDA POSTERIOR 1/4*63 -BAR 0-10 CON GLICERINA	13,3700	133

VÁLVULAS DE RETENCIÓN Y FILTROS

REF.	DESCRIPCIÓN	PVP	PÁG.
26003	VALVULA RETENCION TIPO YORK H*H 1/2	4,0600	136
26004	VALVULA RETENCION TIPO YORK H*H 3/4	5,9900	136
26005	VALVULA RETENCION TIPO YORK H*H 1"	7,3200	136
26006	VALVULA RETENCION TIPO YORK H*H 1"1/4	17,0600	136
26007	VALVULA RETENCION TIPO YORK H*H 1"1/2	16,7500	136
26008	VALVULA RETENCION TIPO YORK H*H 2"	30,4700	136
26009	VALVULA RETENCION TIPO YORK H*H 2"1/2	71,5000	136
26010	VALVULA RETENCION TIPO YORK H*H 3"	65,9800	136
26011	VALVULA RETENCION TIPO YORK H*H 4"	109,1400	136
26016	VALVULA RETENCION CON FILTRO INOX-H*1/2	3,9500	136
26017	VALVULA RETENCION CON FILTRO INOX-H* 3/4	5,4400	136
26018	VALVULA RETENCION CON FILTRO INOX-H* 1"	8,4500	136
26019	VALVULA RETENCION CON FILTRO INOX-H*1"1/4	13,2300	136
26020	VALVULA RETENCION CON FILTRO INOX-H*1"1/2	13,0500	136
26021	VALVULA RETENCION CON FILTRO INOX-H* 2"	24,5500	136
26022	VALVULA RETENCION CON FILTRO INOX-H*2"1/2	49,9500	136
26023	VALVULA RETENCION CON FILTRO INOX-H*3"	75,0900	136
26024	VALVULA RETENCION CON FILTRO INOX-H* 4"	99,2500	136
26101	VALVULA RETENCION EJE LATON H*H 3/8	4,9900	136
26102	VALVULA RETENCION EJE LATON H*H 1/2	4,7200	136
26103	VALVULA RETENCION EJE LATON H*H 3/4	6,5800	136
26104	VALVULA RETENCION EJE LATON H*H 1"	9,7500	136
26105	VALVULA RETENCION EJE LATON H*H 1"1/4	15,9300	136
26106	VALVULA RETENCION EJE LATON H*H 1"1/2	19,3000	136
26107	VALVULA RETENCION EJE LATON H*H 2"	31,1500	136
26108	VALVULA RETENCION EJE LATON H*H 2"1/2	77,3500	136



26109	VALVULA RETENCION EJE LATON H*H 3"	99,9500	136
26110	VALVULA RETENCION EJE LATON H*H 4"	155,4200	136
26202	VALVULA RETENCION M*M 1/2	7,6200	137
26203	VALVULA RETENCION M*M 3/4	9,1500	137
26204	VALVULA RETENCION M*M 1"	12,8800	137
26503	FILTRO VALVULA RETENCION INOX 1/2	0,9900	137
26504	FILTRO VALVULA RETENCION INOX 3/4	1,1800	137
26505	FILTRO VALVULA RETENCION INOX 1"	1,4900	137
26506	FILTRO VALVULA RETENCION INOX 1"1/4	1,9800	137
26507	FILTRO VALVULA RETENCION INOX 1"1/2	2,4000	137
26508	FILTRO VALVULA RETENCION INOX 2"	3,4000	137
26509	FILTRO VALVULA RETENCION INOX 2"1/2	7,9500	137
26510	FILTRO VALVULA RETENCION INOX 3"	8,7500	137
26511	FILTRO VALVULA RETENCION INOX 4"	10,9900	137
26516	FILTRO VALVULA RETENCION ABS 1/2	0,7000	137
26517	FILTRO VALVULA RETENCION ABS 3/4	0,7600	137
26518	FILTRO VALVULA RETENCION ABS 1"	1,1200	137
26519	FILTRO VALVULA RETENCION ABS 1"1/4	1,5100	137
26520	FILTRO VALVULA RETENCION ABS 1"1/2	1,6400	137
26521	FILTRO VALVULA RETENCION ABS 2"	2,4700	137
26601	VALVULA RETENCION CLAPETA H*H 1/2 cierre goma	5,4000	138
26602	VALVULA RETENCION CLAPETA H*H 3/4 cierre goma	10,8900	138
26603	VALVULA RETENCION CLAPETA H*H 1" cierre goma	16,2000	138
26604	VALVULA RETENCION CLAPETA H*H 1"1/4 cierre goma	23,1500	138
26605	VALVULA RETENCION CLAPETA H*H 1"1/2 cierre goma	28,9700	138
26606	VALVULA RETENCION CLAPETA H*H 2" cierre goma	48,3600	138
26607	VALVULA RETENCION CLAPETA H*H 2"1/2 cierre goma	99,6600	138
26608	VALVULA RETENCION CLAPETA H*H 3" cierre goma	145,3500	138
26609	VALVULA RETENCION CLAPETA H*H 4" cierre goma	245,5800	138
26613	FILTRO COLADOR TIPO "Y" H*H 1/2	5,5400	138
26614	FILTRO COLADOR TIPO "Y" H*H 3/4	8,8900	138
26615	FILTRO COLADOR TIPO "Y" H*H 1"	12,5100	138
26616	FILTRO COLADOR TIPO "Y" H*H 1"1/4	23,9400	138
26617	FILTRO COLADOR TIPO "Y" H*H 1"1/2	29,9400	138
26618	FILTRO COLADOR TIPO "Y" H*H 2"	57,4400	138
26619	FILTRO COLADOR TIPO "Y" H*H 2"1/2	125,9700	138
26620	FILTRO COLADOR TIPO "Y" H*H 3"	132,2000	138
26621	FILTRO COLADOR TIPO "Y" H*H 4"	164,3000	138
26622	VALVULA COMPUERTA CIERRE GOMA H-H 1/2	11,4600	138
26623	VALVULA COMPUERTA CIERRE GOMA H-H 3/4	15,1200	138
26624	VALVULA COMPUERTA CIERRE GOMA H-H 1"	24,6700	138
26625	VALVULA COMPUERTA CIERRE GOMA H-H 1 1/4	42,9000	138
26626	VALVULA COMPUERTA CIERRE GOMA H-H 1 1/2	58,9900	138
26627	VALVULA COMPUERTA CIERRE GOMA H-H 2"	75,4000	138
26628	VALVULA COMPUERTA CIERRE GOMA H-H 2 1/2	173,0800	138
26629	VALVULA COMPUERTA CIERRE GOMA H-H 3"	159,6000	138
26630	VALVULA COMPUERTA CIERRE GOMA H-H 4"	322,5600	138
22542	VALVULA ESFERA H*H*H 1/2 TRES VIAS TIPO*L	39,2000	139
22543	VALVULA ESFERA H*H*H 3/4 TRES VIAS TIPO*L	59,8400	139
22544	VALVULA ESFERA H*H*H 1" TRES VIAS TIPO*L	81,1000	139
22545	VALVULA ESFERA H*H*H 1 1/4 TRES VIAS TIPO*L	162,4500	139
22546	VALVULA ESFERA H*H*H*1 1/2 TRES VIAS TIPO * L	194,6900	139
22547	VALVULA ESFERA H*H*H*2" TRES VIAS TIPO * L	246,0500	139
22552	VALVULA ESFERA H*H*H 1/2 TRES VIAS TIPO*T	27,7800	139



22553	VALVULA ESFERA H*H*H 3/4 TRES VIAS TIPO*T	45,4000	139
22554	VALVULA ESFERA H*H*H 1" TRES VIAS TIPO*T	81,1000	139
22555	VALVULA ESFERA H*H*H 1 1/4 TRES VIAS TIPO*T	162,4500	139
22556	VALVULA ESFERA H*H*H*1 1/2 TRES VIAS TIPO*T	194,6900	139
22557	VALVULA ESFERA H*H*H* 2" TRES VIAS TIPO*T	246,0500	139
26640	VALVULA COMPUERTA CIERRE LATON H-H 1/2	5,2400	139
26641	VALVULA COMPUERTA CIERRE LATON H-H 3/4	8,7300	139
26642	VALVULA COMPUERTA CIERRE LATON H-H 1"	13,9300	139
26643	VALVULA COMPUERTA CIERRE LATON H-H 1 1/4	14,1800	139
26644	VALVULA COMPUERTA CIERRE LATON H-H 1 1/2	19,8800	139
26645	VALVULA COMPUERTA CIERRE LATON H-H 2"	48,8200	139
26646	VALVULA COMPUERTA CIERRE LATON H-H 2 1/2	85,6500	139
26647	VALVULA COMPUERTA CIERRE LATON H-H 3"	95,7100	139
26648	VALVULA COMPUERTA CIERRE LATON H-H 4"	287,3700	139
26660	VALVULA ESFERA CON RETENCION H-H 1/2	10,9500	139
26661	VALVULA ESFERA CON RETENCION H-H 3/4	17,7900	139
26662	VALVULA ESFERA CON RETENCION H-H 1"	29,6100	139
26666	VALVULA ESFERA ENTRADA CONTADOR ORIENTABLE DN-15 RACOR 3/4	18,9800	140
26667	VALVULA ESFERA ENTRADA CONTADOR ORIENTABLE DN-15 RACOR 7/8	21,7200	140
26670	MANGUITO CONTADOR DN20-3/4 - ROSCAS IZQUIERDA/DERECHA	2,2400	140
26671	MANGUITO CONTADOR DN15-7/8 - ROSCAS IZQUIERDA/DERECHA	3,5500	140
26673	MANGUITO CONTADOR DN15-3/4 - ROSCAS IZQUIERDA/DERECHA	2,9600	140
26675	VALVULA ESFERA SALIDA CONTADOR ANTIRRETORNO DN-15 * 3/4	11,4000	140
26676	VALVULA ESFERA 3/4 PALOMILLA CON BRIDA ORIENTABLE- H 3/4	15,8600	140
26678	MANGUITO CONTADOR 3/4" IZQ-7/8 DRCH	2,8000	140
99083	CUERPO BRIDA NIQUEL 3/4	5,0700	140
99093	LATERAL BRIDA NIQUEL 3/4	2,2900	140
99344	JUNTA CAUCHO BRIDA ORIENTABLE	1,6000	140

RACORES DE CONTADOR Y ACCESORIOS

REF.	DESCRIPCIÓN	PVP	PÁG.
83510	JUNTA RACOR CONTADOR 2" x 2"1/2-50 x 70 x 4	0,5100	142
83511	JUNTA RACOR CONTADOR 1" x 1 1/4-28,5 x 37,5 x 2,5	0,1800	142
83512	JUNTA RACOR CONTADOR 1"1/4 x 1"1/2-35 x 45 x 3	0,3900	142
83513	JUNTA RACOR CONTADOR 1"1/2 x 2"-44 x 55 x 3	0,4200	142
83604	JUNTA RACOR CONTADOR 1/2 x 1/2 -14 x 18,5 x 2	0,0350	142
84510	JUNTA RACOR CONTADOR GAS 7/8 x 18/22 -22 x 27 x 2,5	0,0980	142
89076	RACOR CONTADOR CON TUERCA Y JUNTA 1 1/4 x 1"	9,7900	142
89077	RACOR CONTADOR CON TUERCA Y JUNTA 1 1/2 x 1 1/4	12,8100	142
89078	RACOR CONTADOR CON TUERCA Y JUNTA 2 x 1 1/2	19,1400	142
89083	RACOR CONTADOR CON TUERCA Y JUNTA 7/8 x 1/2	4,6400	142
89090	PURGADOR CON TORNILLO ROSCAR	1,3200	142
89091	JUNTA RACOR CONTADOR 1" x 3/4 -22 x 30 x 2,5	0,1200	142
89092	JUNTA RACOR CONTADOR 1/2 x 3/4 -17 x 23,5 x 2,5	0,0800	142
89093	JUNTA RACOR CONTADOR 7/8 x 1/2- 20 x 27 x 2,5	0,0900	142
89101	JUNTA RACOR CONTADOR 5/8 x 1/2- 14 x 21 x 2	0,0800	142
90091	PORTILLA ACERO INOX 2 ENTRADAS 450*300*110	165,6500	142
98061	RACOR CONTADOR TELESCOPICO CON JUNTA 7/8 x 3/4 x 90 mm	31,1600	142
98079	RACOR CONTADOR CON TUERCA Y JUNTA 2 1/2 x 2	21,9900	142
98080	RACOR CONTADOR CON JUNTA 5/8 x 1/2	7,2300	142
98101	RACOR CONTADOR TELESCOPICO CON JUNTA M-H 3/4 x 3/4 x 66 mm	18,4800	142
98105	RACOR CONTADOR TELESCOPICO CON JUNTA 3/4 x 3/4 x 90 mm	29,9900	142
99522	RACOR CONTADOR CON TUERCA Y JUNTA 1/2 x 1/2	6,8800	142
89080A	RACOR CONTADOR SOLDAR CON PURGADOR 7/8 *18/22	4,4500	142



89081A	RACOR CONTADOR CON TUERCA Y JUNTA 3/4 x 1/2	3,5100	142
89083A	RACOR CONTADOR SOLDAR CON PURGADOR 3/4x18	4,4500	142
89085A	RACOR CONTADOR CON TUERCA Y JUNTA 1 x 3/4	5,4700	142
30013	RACOR RECTO ARILLO LATON HEMBRA-TUBO 1/2*20	3,4100	144
30014	RACOR RECTO ARILLO LATON HEMBRA-TUBO 3/4*25	5,1400	144
30015	RACOR RECTO ARILLO LATON HEMBRA-TUBO 1"*32	6,7100	144
30016	RACOR RECTO ARILLO LATON HEMBRA-TUBO 1 1/4"*40	14,3000	144
30017	RACOR RECTO ARILLO LATON HEMBRA-TUBO 1 1/2*50	22,2800	144

ACCESORIOS TUBO POLIETILENO

REF.	DESCRIPCIÓN	PVP	PÁG.
30018	RACOR RECTO ARILLO LATON HEMBRA-TUBO 2"	34,7700	144
31513	RACOR RECTO ARILLO LATON MACHO-TUBO 1/2*20	2,9900	144
31514	RACOR RECTO ARILLO LATON MACHO-TUBO 3/4*25	4,4800	144
31515	RACOR RECTO ARILLO LATON MACHO-TUBO 1"*32	8,4600	144
31516	RACOR RECTO ARILLO LATON MACHO-TUBO 1 1/4*40	13,6600	144
31517	RACOR RECTO ARILLO LATON MACHO-TUBO 1 1/2*50	15,6400	144
31518	RACOR RECTO ARILLO LATON MACHO-TUBO 2"*63	23,2100	144
33013	RACOR UNION ARILLO LATON TUBO-TUBO 20*20	5,1500	144
33014	RACOR UNION ARILLO LATON TUBO-TUBO 25*25	8,0500	144
33015	RACOR UNION ARILLO LATON TUBO-TUBO 32*32	13,6900	144
33016	RACOR UNION ARILLO LATON TUBO-TUBO 40*40	19,3300	144
33017	RACOR UNION ARILLO LATON TUBO-TUBO 50*50	25,8800	144
33018	RACOR UNION ARILLO LATON TUBO-TUBO 63*63	37,7200	144
36013	RACOR CODO ARILLO LATON MACHO-TUBO 1/2*20	3,6600	144
36014	RACOR CODO ARILLO LATON MACHO-TUBO 3/4*25	7,1800	144
36015	RACOR CODO ARILLO LATON MACHO-TUBO 1"*32	10,5900	144
36016	RACOR CODO ARILLO LATON MACHO-TUBO 1 1/4*40	20,8000	144
36017	RACOR CODO ARILLO LATON MACHO-TUBO 1 1/2*50	23,9200	144
36018	RACOR CODO ARILLO LATON MACHO-TUBO 2"*63	45,3200	144
37513	RACOR CODO HEMBRA-TUBO ARILLO LATON 1/2*20	4,9900	144
37514	RACOR CODO HEMBRA-TUBO ARILLO LATON 3/4*25	6,8800	144
37515	RACOR CODO HEMBRA-TUBO ARILLO LATON 1"*32	10,6500	144
37516	RACOR CODO HEMBRA-TUBO ARILLO LATON 1 1/4*40	16,4200	144
37517	RACOR CODO HEMBRA-TUBO ARILLO LATON 1 1/2*50	24,2400	144
37518	RACOR CODO HEMBRA-TUBO ARILLO LATON 2*63	41,8000	144
34513	RACOR CODO UNION ARILLO LATON TUBO-TUBO 20*20	6,0500	145
34514	RACOR CODO UNION ARILLO LATON TUBO-TUBO 25*25	8,9800	145
34515	RACOR CODO UNION ARILLO LATON TUBO-TUBO 32*32	14,5000	145
34516	RACOR CODO UNON ARILLO LATON TUBO-TUBO 40*40	26,6500	145
34517	RACOR CODO UNION ARILLO LATON TUBO-TUBO 50*50	43,8800	145
34518	RACOR CODO UNION ARILLO LATON TUBO-TUBO 63*63	51,9900	145
37519	CODO PLACA HEMBRA-TUBO ARILLO LATON 1/2*20	6,0900	145
37520	CODO PLACA HEMBRA-TUBO ARILLO LATON 3/4*25	9,7900	145
37521	CODO PLACA HEMBRA-TUBO ARILLO LATON 1"*32	15,9200	145
37526	RACOR CODO PLACA HEMBRA A TUBO ARILLO LATON 3/4"*25 Ø	7,8300	145
38013	RACOR TE HEMBRA-TUBO ARILLO LATON 1/2*20	5,9900	145
38014	RACOR TE HEMBRA-TUBO ARILLO LATON 3/4*25	13,0600	145
38015	RACOR TE HEMBRA-TUBO ARILLO LATON 1"*32	15,2500	145
38016	RACOR TE HEMBRA-TUBO ARILLO LATON 1 1/4*40	31,3500	145
38017	RACOR TE HEMBRA-TUBO ARILLO LATON 1 1/2*50	34,5500	145
38018	RACOR TE HEMBRA-TUBO ARILLO LATON 2"	58,7700	145
39013	RACOR TE ACOPLAMIENTO A TUBO ARILLO LATON 20*20*20	7,7900	145
39014	RACOR TE ACOPLAMIENTO A TUBO ARILLO LATON 25*25*25	13,2000	145



39015	RACOR TE ACOPLAMIENTO A TUBO ARILLO LATON 32*32*32	19,5000	145
39016	RACOR TE ACOPLAMIENTO A TUBO ARILLO LATON 40*40*40	31,0600	145
39017	RACOR TE ACOPLAMIENTO A TUBO ARILLO LATON 50*50*50	66,0200	145
39018	RACOR TE ACOPLAMIENTO A TUBO ARILLO LATON 63*63*63	66,7900	145
30009	RACOR RECTO HEMBRA-TUBO CON BRIDAS 2"1/2*75	90,4400	146
30010	RACOR RECTO HEMBRA-TUBO CON BRIDAS 3"*90	134,1900	146
30011	RACOR RECTO HEMBRA-TUBO CON BRIDAS 4"*110	217,7300	146
31509	RACOR RECTO MACHO-TUBO CON BRIDAS 2" 1/2*75	88,9600	146
31510	RACOR RECTO MACHO-TUBO CON BRIDAS 3"*90	143,5000	146
31511	RACOR RECTO MACHO-TUBO CON BRIDAS 4"*110	199,6000	146
33009	RACOR UNION TUBO-TUBO CON BRIDAS 75*75	122,4400	146
33010	RACOR UNION TUBO-TUBO CON BRIDAS 90*90	210,8100	146
33011	RACOR UNION TUBO-TUBO CON BRIDAS 110*110	399,5000	146
36009	RACOR CODO MACHO-TUBO CON BRIDAS 2 1/2*75	107,7400	146
36010	RACOR CODO MACHO-TUBO CON BRIDAS 3"*90	160,2400	146
37509	RACOR CODO HEMBRA-TUBO CON BRIDAS 75*2"1/2	136,7000	146
37510	RACOR CODO HEMBRA-TUBO CON BRIDAS 90*3"	181,8200	146
37511	RACOR CODO HEMBRA-TUBO CON BRIDAS 110*4"	336,6000	146
34509	RACOR CODO UNION TUBO-TUBO CON BRIDAS 75*75	198,1700	147
34510	RACOR CODO UNION TUBO-TUBO CON BRIDAS 90*90	276,4000	147
38009	RACOR TE HEMBRA-TUBO CON BRIDAS 75*2"1/2	218,6200	147
38010	RACOR TE HEMBRA-TUBO CON BRIDAS 90*3"	254,4700	147
38011	RACOR TE HEMBRA-TUBO CON BRIDAS 110x4"	526,6700	147
39009	RACOR TE ACOPLAMIENTO A TUBO CON BRIDAS 75*75*75	251,0500	147
39010	RACOR TE ACOPLAMIENTO A TUBO CON BRIDAS 90*90*90	318,4700	147
39019	ARILLO ABIERTO LATON DE 20	0,7700	148
39020	ARILLO ABIERTO LATON DE 25	0,8700	148
39021	ARILLO ABIERTO LATON DE 32	1,3500	148
39022	ARILLO ABIERTO LATON DE 40	1,7700	148
39023	ARILLO ABIERTO LATON DE 50	3,2500	148
39024	ARILLO ABIERTO LATON DE 63	4,5900	148
39025	ARILLO ABIERTO RESINA DE 20	0,1400	148
39026	ARILLO ABIERTO RESINA DE 25	0,1800	148
39027	ARILLO ABIERTO RESINA DE 32	0,2100	148
39028	ARILLO ABIERTO RESINA DE 40	0,3200	148
39029	ARILLO ABIERTO RESINA DE 50	0,3900	148
39030	ARILLO ABIERTO RESINA DE 63	0,6100	148
39031	JUNTA TORICA NBR 20,29 x 2,62 RACORES DE 20	0,1000	148
39032	JUNTA TORICA NBR 25 x 3 RACORES DE 25	0,1500	148
39033	JUNTA TORICA NBR 31,34 x 3,53 RACORES DE 32	0,1500	148
39034	JUNTA TORICA NBR 40 x 3,8 RACORES 1 1/4	0,3600	148
39035	JUNTA TORICA NBR 49,5 x 4,5 RACORES DE 50	0,5600	148
39036	JUNTA TORICA NBR 62,87 x 5,33 RACORES DE 63	0,8000	148
39050	ARANDELA LATON APRIETE DE 20	0,4800	148
39051	ARANDELA LATON APRIETE DE 25	0,5800	148
39052	ARANDELA LATON APRIETE DE 32	0,6700	148
39053	ARANDELA LATON APRIETE DE 40	1,2600	148
39054	ARANDELA LATON APRIETE DE 50	1,7500	148
39055	ARANDELA LATON APRIETE DE 63	3,0800	148
39060	ARANDELA RESINA APRIETE DE 20	0,1200	148
39061	ARANDELA RESINA APRIETE DE 25	0,1600	148
39062	ARANDELA RESINA APRIETE DE 32	0,1700	148
39063	ARANDELA RESINA APRIETE DE 40	0,2800	148
39064	ARANDELA RESINA APRIETE DE 50	0,3200	148



39065	ARANDELA RESINA APRIETE DE 63	0,6000	148
--------------	-------------------------------	--------	-----

GRIFOS FLOTADORES Y BOYAS

REF.	DESCRIPCIÓN	PVP	PÁG.
57501	FLOTADOR CAZOLETA 3/8	4,3500	150
57502	FLOTADOR CAZOLETA 1/2	9,1000	150
58002	FLOTADOR GUIAS TODO PASO 3/8 -ROSCA M-3/16	6,2500	150
58003	FLOTADOR GUIAS TODO PASO ASIEN TO INOX 1/2-ROSCA M-6/100	8,5000	150
58004	FLOTADOR GUIAS TODO PASO ASIEN TO INOX 3/4-ROSCA M-6/100	12,9000	150
58005	FLOTADOR GUIAS TODO PASO ASIEN TO INOX 1"-ROSCA M- 8/100	18,9800	150
58006	FLOTADOR GUIAS TODO PASO ASIEN TO INOX 1"1/4-ROSCA M- 9/100	45,5000	150
58007	FLOTADOR GUIAS TODO PASO ASIEN TO INOX 1"1/2 -ROSCA M-9/100	51,9400	150
58008	FLOTADOR GUIAS TODO PASO ASIEN TO INOX 2"-ROSCA M-9/100	82,8500	150
58016	FLOTADOR GUIAS TODO PASO ARTICULADO 1/2-ROSCA M-6/100	9,9300	150
58017	FLOTADOR GUIAS TODO PASO ARTICULADO 3/4 -ROSCA M- 6/100	14,4500	150
58018	FLOTADOR GUIAS TODO PASO ARTICULADO 1"-ROSCA M 8/100	19,6500	150
58019	FLOTADOR GUIAS ASIEN TO INOX VARILLA DESLIZANTE 1/2	9,9500	150
58020	FLOTADOR GUIAS ASIEN TO INOX VARILLA DESLIZANTE 3/4	14,2800	150
58021	FLOTADOR GUIAS ASIEN TO INOX VARILLA DESLIZANTE 1"	22,2500	150
58022	FLOTADOR GUIAS ASIEN TO INOX VARILLA DESLIZANTE 1 1/4	53,6500	150
58023	FLOTADOR GUIAS ASIEN TO INOX VARILLA DESLIZANTE 1 1/2	70,9500	150
58024	FLOTADOR GUIAS ASIEN TO INOX VARILLA DESLIZANTE 2"	101,8600	150
58025	FLOTADOR GUIAS VARILLA DESLIZANTE 2 1/2	303,9900	150
58026	FLOTADOR GUIAS VARILLA DESLIZANTE 3"	373,6900	150
58040	FLOTADOR INOX (AIXI 304)CIERRE SILICONA 3/8-ROSCA M 6/100	24,9200	150
58041	FLOTADOR INOX (AIXI 304) CIERRE SILICONA 1/2-ROSCA M-6/100	26,4500	150
58042	FLOTADOR INOX (AIXI 304) CIERRE SILICONA 3/4-ROSCA M-8/100	45,1800	150
58043	FLOTADOR INOX (AIXI 304) CIERRE SILICONA 1" ROSCA M-8/100	49,7300	150
58044	FLOTADOR INOX (AIXI 304) CIERRE SILICONA 1 1/4 ROSCA M-8/100	54,7800	150
58517	VARILLA FLOTADOR CAZOLETA ROSCA 3/16 *230mm	0,8000	150
57001	FLOTADOR SILENCIOSO TANQUE ALTO-MACHO 3/8	4,2500	151
57002	FLOTADOR SILENCIOSO TANQUE BAJO-MACHO 3/8	3,5800	151
57003	FLOTADOR SILENCIOSO TANQUE ALTO-HEMBRA 3/8	3,9000	151
57007	FLOTADOR REGULABLE CON BOYA-ALI.LATERAL MIXTO ABS-LATON--3/8	7,5500	151
57011	FLOTADOR REGULABLE CON BOYA-ALI.VERTICAL MIXTO ABS-LATON--3/8	8,5000	151
57013	GRIFO FLOTADOR VERTICAL REGULABLE EN ALTURA 3/8*COLONIAL*	14,1300	151
57014	GRIFO FLOTADOR LATERAL 3/8*COLONIAL*	14,2000	151
57015	GRIFO FLOTADOR DUO 3/8"	14,5000	151
58500	BOYA POREXPAN CILINDRICA	0,9900	152
58501	BOYA POREXPAN 3/8 ROSCA 3/16 * 90 mm	0,9800	152
58502	BOYA POREXPAN 1/2 ROSCA 3/16 * 110 mm	1,5200	152
58503	BOYA PLASTICO 1/2 ROSCA 6/100 * 110 mm	2,5100	152
58504	BOYA PLASTICO 3/4 ROSCA 6/100 * 130 mm	2,6200	152
58505	BOYA PLASTICO 1" ROSCA 8/100 * 150 mm	3,8000	152
58506	BOYA PLASTICO 1"1/4-1"1/2 ROSCA 9/100 * 200 mm	5,1900	152
58507	BOYA PLASTICO 2" ROSCA 9/100 * 230 mm	7,1900	152
58508	BOYA PLASTICO 3/8 ROSCA 3/16 * 90 mm	1,2000	152
58516	BOYA POREXPAN 1/2 ROSCA 6/100 * 110 mm	1,5400	152
58519	BOYA POREXPAN 3/4 ROSCA 6/100 * 160 mm	2,4800	152
58530	BOYA PLASTICO CORREDERA Y FIJA 1/2-3/4 ROSCA 6/100*120 mm	5,9500	152
58531	BOYA PLASTICO CORREDERA Y FIJA ROSCA 8/100 1" * 150 mm	6,7500	152
58532	BOYA PLASTICO CORREDERA Y FIJA 1" 1/4-1"1/2- 2" ROSCA 9/100* 200 mm	9,6500	152
58533	BOYA PLASTICO CORREDERA Y FIJA 2" 1/2- 3" ROSCA 9/100* 250 mm	12,7800	152
58534	BOYA PLASTICO 3/8 ROSCA 6/100*90 mm	0,9200	152



58537	BOYA PLASTICO 1/2 ROSCA 3/16*110 mm	2,5000	152
58538	BOYA PLASTICO 3/4 ROSCA 7/100 *130 mm	2,8200	152
58539	BOYA PLASTICO 1"ROSCA*6/100 150 mm	3,6000	152
58509	BOYA COBRE VARILLA DESLIZANTE 1/2 x 120 mm	23,2700	153
58510	BOYA COBRE VARILLA DESLIZANTE 3/4 x 150 mm	28,7600	153
58511	BOYA COBRE VARILLA DESLIZANTE 1" x 170 mm	32,8900	153
58512	BOYA COBRE VARILLA DESLIZANTE 1 1/4 x 200 mm	76,9000	153
58513	BOYA COBRE VARILLA DESLIZANTE 1 1/2 x 230 mm	85,4100	153
58514	BOYA COBRE VARILLA DESLIZANTE 2" x 250 mm	87,9500	153
58515	BOYA COBRE VARILLA DESLIZANTE 2 1/2 x 280 mm	123,0500	153
58518	BOYA COBRE VARILLA DESLIZANTE 3" x 300 mm	142,6300	153
58520	BOYA LATON 1/2 ROSCA 6/100 x 110 mm	18,9800	153
58521	BOYA LATON 3/4 ROSCA 6/100 x 130 mm	21,7000	153
58522	BOYA LATON 1" ROSCA 8/100 x 150 mm	26,9800	153
58523	BOYA LATON 1 1/4 ROSCA 9/100 x 180 mm	57,5000	153
58524	BOYA LATON 1 1/2 ROSCA 9/100 x 200 mm	66,4600	153
58525	BOYA LATON 2" ROSCA 9/100 x 230 mm	56,6300	153
58526	BOYA LATON 3/8 ROSCA 3/16 x 90 mm	14,6700	153
58544	BOYA FLOTADOR -INOX 304 - 1/2 *110-ROSCA M- 6/100	26,7000	153
58545	BOYA FLOTADOR -INOX 304 - 3/4-1"-1 1/4 *160-ROSCA M-8/100	54,9400	153
58546	BOYA FLOTADOR -INOX 304 -3/8*90- ROSCA M-6/100	21,3000	153
57016	JUNTA MEMBRANA GRIFO FLOTADOR SILENCIOSO 3/8 x 18,5 mm	0,2500	154
57017	JUNTA MEMBRANA GRIFO FLOTADOR VERTICAL 3/8 x 24 mm	0,2900	154
57020	TUERCA PLASTICO CON VALONA BLANCA 3/8	0,2000	154
57021	TUERCA PLASTICO CON VALONA BLANCA 1/2	0,2400	154
72050	JUNTA TAZA-TANQUE CISTERNA BAJA 57 x 97 mm	1,4100	154
72051	JUNTA CIERRE TAZA-TANQUE ESPUMA ESPECIAL	1,8200	154

CISTERNA E INODORO

REF.	DESCRIPCIÓN	PVP	PÁG.
72001	DESCARGADOR CISTERNA PVC TANQUE ALTO	4,3700	156
72002	CAMPANA DESCARGADOR CISTERNA PVC TANQUE ALTO	3,5500	156
72003	REBOSADERO CON TOPE DESCARGADOR TANQUE ALTO	0,4000	156
72004	OBTURADOR GOMA DESCARGADOR TANQUE ALTO 5mm -Dia,45mm	0,5000	156
72005	GANCHILLO DESCARGADOR TANQUE ALTO ACERO INOX	0,3500	156
72012	GOMA BAJANTE CISTERNA TANQUE ALTO CONICA 32 mm	0,3500	156
72046	OBTURADOR GOMA DESCARGADOR TANQUE ALTO 7 mm-Dia,45 mm	0,5500	156
72006	DESCARGADOR CISTERNA PVC TANQUE BAJO	4,2900	157
72007	CAMPANA DESCARGADOR CISTERNA ABS TANQUE BAJO	3,6300	157
72008	OBTURADOR CON CUELLO GOMA LATEX 18 x 67 mm	0,6900	157
72009	OBTURADOR GOMA LATEX SIN CUELLO ROCA ANTIGUA 22 x 73 mm	0,9000	157
72010	GOMA ASIEN TO ROCA SILICONA TANQUE BAJO 75 x 50 mm	0,6200	157
72011	BASE CON TUERCA DESCARGADOR CISTERNA TANQUE BAJO	2,4900	157
72039	DESCARGADOR DE PULSADOR SIMPLE CON CABLE BASE RECAMBIO ROCA	15,9600	158
72041	DESCARGADOR CISTERNA DE DOBLE PULSADOR UNIVERSAL	17,5700	158
72042	DESCARGADOR CISTERNA DOBLE PULSADOR CON CABLE ORIENTABLE	17,5700	158
72043	DESCARGADOR DOBLE PULSADOR REGULABLE EN ALTURA	7,9800	158
72044	DESCARGADOR CISTERNA DE PULSADOR ININTERRUMPIBLE ADAPTABLE SISTEMA ROCA ACTUAL	17,5700	158
72045	GOMA OBTURADORA CIERRE ART.72044	1,3400	158
72047	GOMA OBTURADORA ART,72041-72042	1,2800	158
72048	PULSADOR DESCARGADOR ART,72041	4,8200	158
72049	PULSADOR DESCARGADOR ART,72042	4,4800	158
72052	PULSADOR DESCARGADOR ART,72044	3,9400	158



72013	PALANCA DESCARGADOR CISTERNA ABS	0,5600	159
72014	PALANCA DESCARGADOR CISTERNA ACERO GALVANIZADA	2,0400	159
72015	CASCO CISTERNA ABS BLANCO	5,4400	159
72016	CONJUNTO CISTERNA COMPLETO TANQUE ALTO	11,0500	159
72017	PALANCA DESCARGADOR CISTERNA CON SOPORTE LATON	3,9300	159
72018	JUEGO TORNILLO PALANCA DESCARGADOR CISTERNA	0,4300	159
72020	BAJANTE DE CISTERNA ABS COMPLETA	9,9500	159
72021	TIRADOR CISTERNA PLANO BLANCO TANQUE ALTO	0,9800	160
72022	TIRADOR CISTERNA REDONDO BLANCO TANQUE ALTO	1,5600	160
72023	TIRADOR CISTERNA BOMBILLA CRISTAL TANQUE ALTO	1,8500	160
72025	TIRADOR ABS CISTERNA TANQUE BAJO RECTO	2,9900	160
72026	TIRADOR METAL CISTERNA TANQUE BAJO RECTO	3,4100	160
72027	TIRADOR ABS CISTERNA TANQUE BAJO CURVO	2,4000	160
72028	TIRADOR METAL CISTERNA TANQUE BAJO CURVO	3,4100	160
72038	TIRADOR CISTERNA ANILLA BLANCO TANQUE ALTO	1,9800	160
72030	JUNTA DESCARGA ROCA ANTIGUA CAUCHO *23 x 70 x 3 mm	0,5900	161
72031	JUNTA DESCARGA ROCA NUEVA*33 x 68 x 3 mm	0,4900	161
72032	DISCO FLOTADOR ROCA 29*3 mm	0,1700	161
72033	JUNTA SEMI-PLANA FREGADERO 40 x 68 x 5,5 mm	0,7600	161
72034	JUNTA SEMI-PLANA BAÑERA 45 x 79 x 6,5 mm	1,9900	161
25543	MANGUITO GOMA FLEXIBLE WC RECTO DE 110	3,5000	162
25544	MANGUITO GOMA FLEXIBLE WC EXCENTRICO DE 110	3,5000	162
25545	MANGUITO CONEXION WC EXCENTRICO DE 90 CON JUNTAS	4,6500	162
25546	MANGUITO CONEXION WC RECTO DE 90 CON JUNTAS	4,6500	162
25547	MANGUITO CONEXION WC EXCENTRICO DE 110	4,6500	162
63505	MANGUITO INODORO EXTENSIBLE - 90-100-110 x 250/530	6,3500	162
25548	GOMA MANGUITO SUPERIOR DE 90	2,3200	163
25549	GOMA MANGUITO LABIADA DE 90	1,3400	163
70046	TAPON ROSCA HEMBRA POLIETILENO 1 1/2	1,6000	163
74001	TAPON HEMBRA ABS 1"	0,9700	163
74005	TAPON MACHO PVC 1/2	0,1100	163
74006	TAPON MACHO PVC 3/4	0,2800	163
74007	TAPON MACHO PVC 3/8	0,1700	163
74008	TAPON HEMBRA ABS 1/2"	0,5400	163
74009	TAPON HEMBRA ABS 3/4"	0,6300	163
74010	TAPON ROSCA MACHO POLIETILENO 1 1/2	1,6100	163
74011	TAPON ROSCA MACHO POLIETILENO 2"	2,8000	163
63516	MANGUITO INODORO COMPRIMIBLE -90-100-110 x 400	10,3000	164
98090	TAPA INODORO ABS BLANCO MODELO LUCIAN	37,3500	164
98091	JUEGO TORNILLOS SUJECION LUCIAN	6,7200	164
98097	TAPA INODORO UNIVERSAL BLANCA	14,2800	164
98098	TAPA INODORO CONTINENTAL BLANCA	25,5000	164
98099	JUEGO TORNILLO TAPA CONTINENTAL	6,7200	164
99248	JUEGO TORNILLO TAPA INODORO STANDAR	3,9300	164
72019	EJE PORTARROLLOS ABS BLANCO	0,7000	165
98093	ESCOBILLERO COMPLETO ABS	5,3600	165
98094	ESCOBILLA SUELTA BLANCA	2,4900	165
98095	BANQUETA DE BAÑO ABS	24,0200	165

ACCESORIOS DE FIJACIÓN

REF.	DESCRIPCIÓN	PVP	PÁG.
62001	JUEGO 2 TORNILLOS FIJACION INODORO/BIDE 5*75 ACERO INOX	1,4600	168
62002	JUEGO 2 TORNILLOS FIJACION INODORO/BIDE 5*75 ACERO	0,5100	168
62003	JUEGO 2 TORNILLOS FIJACION INODORO/ BIDE 5 x 75 LATON	0,9900	168



62010	JUEGO 4 TORNILLOS FIJACION INODORO/BIDE 5 x 75 ACERO	0,9600	168
62015	JUEGO 2 TORNILLOS FIJACION INODORO CON SOPORTE NYLON HORIZONTAL	1,5600	168
99150	JUEGO TORNILLO INODORO LATERAL GONDOLA	1,3900	168
99151	JUEGO TOR. INO.LATERAL GONDOLA CON EMBELLECEDOR CROMADO	1,8600	168
62004	JUEGO 2 TORNILLOS SUJECION LAVABO 8 x 90 ACERO	1,2200	169
62005	JUEGO 2 TORNILLOS SUJECION LAVABO 10 x 110 ACERO	0,8800	169
62006	JUEGO TORNILLO TAZA-TANQUE M-6 x 80 ACERO	1,2800	169
62007	JUEGO 2 TORNILLOS SOPORTE CALENTADOR M-8 x 60 ACERO	0,9400	169
62008	JUEGO 2 TORNILLOS SOPORTE CALENTADOR M-8 x 70 ACERO	0,9400	169
62013	JUEGO TORNILLO TAZA-TANQUE M-6 x 80 ACERO INOX	1,7100	169
62014	JUEGO 2 TORNILLOS SUJECION MOCHILA NYLON	0,6800	169
62502	TACO GRIS ESTRIADO DE 6 *GRIS*	0,0190	169
62504	TACO GRIS ESTRIADO DE 8*GRIS*	0,0240	169
62506	TACO GRIS ESTRIADO DE 10	0,0420	169
62508	TACO GRIS ESTRIADO DE 12*GRIS*	0,0770	169
63002	JUEGO 2 ESCUADRAS SUJECION LAVABO PALA DE 10 cm.	1,9400	169
63003	JUEGO ESCUADRA SUJECION LAVABO PALA DE 13 cm.	2,3800	169

RACORERÍA DE LATÓN ROSCAR

REF.	DESCRIPCIÓN	PVP	PÁG.
66000	MACHON DOBLE S/COLOR M-M 1/8	0,4300	172
66001	MACHON DOBLE S/COLOR M-M 1/4	0,5900	172
66002	MACHON DOBLE S/COLOR M-M 3/8	0,6700	172
66003	MACHON DOBLE S/COLOR M-M 1/2	0,9200	172
66004	MACHON DOBLE S/COLOR M-M 3/4	1,4200	172
66005	MACHON DOBLE S/COLOR M-M 1"	2,4200	172
66006	MACHON DOBLE S/COLOR M-M 1"1/4	4,9700	172
66007	MACHON DOBLE S/COLOR M-M 1"1/2	5,9900	172
66008	MACHON DOBLE S/COLOR M-M 2"	8,7500	172
66009	MACHON DOBLE S/COLOR M-M 2"1/2	19,3000	172
66010	MACHON DOBLE NIQUEL M-M 1/4	0,6500	172
66011	MACHON DOBLE NIQUEL M-M 3/8	0,7900	172
66012	MACHON DOBLE NIQUEL M-M 1/2	1,1400	172
66013	MACHON DOBLE NIQUEL M-M 3/4	1,4500	172
66014	MACHON DOBLE NIQUEL M-M 1"	2,1400	172
66015	MACHON DOBLE S/COLOR M-M 3"	22,9800	172
66016	MACHON DOBLE S/COLOR M-M 4"	76,9300	172
66020	MACHON DOBLE NIQUEL M-M 1 1/4	3,9300	172
66021	MACHON DOBLE NIQUEL M-M 1 1/2	5,6500	172
66022	MACHON DOBLE NIQUEL M-M 2"	9,9600	172
66023	MACHON DOBLE NIQUEL M-M 2"1/2	16,3500	172
67000	MACHON REDUCIDO M-M 1/4*3/8 S/COLOR	0,9900	172
67001	MACHON REDUCIDO M-M 1/2*3/8 S/COLOR	1,0500	172
67002	MACHON REDUCIDO M-M 3/4*1/2 S/COLOR	1,6200	172
67003	MACHON REDUCIDO M-M 1"*3/4 S/COLOR	2,2400	172
67004	MACHON REDUCIDO M-M 1"1/4*1" S/COLOR	3,3400	172
67005	MACHON REDUCIDO M-M 1"1/2*1"1/4 S/COLOR	6,7200	172
67006	MACHON REDUCIDO M-M 2"*1"1/2 S/COLOR	10,1600	172
67007	MACHON REDUCIDO M-M 1"*1/2 S/COLOR	2,8200	172
67008	MACHON REDUCIDO M-M 1"1/2*1/2 S/COLOR	4,9200	172
67009	MACHON REDUCIDO M-M 2 1/2 *1 1/4 S/COLOR	21,7500	172
67014	MACHON REDU.MM S/COLOR 2 1/2 *1 1/2	17,9500	172
67015	MACHON REDUCIDO M-M 1"1/4*3/4 S/COLOR	4,3500	172
67017	MACHON REDUCIDO M-M 1/8 *3/8 S/COLOR	0,9400	172



67020	MACHON REDUCIDO M-M 1"1/2*3/4 S/COLOR	5,9300	172
67021	MACHON REDUCIDO M-M 1"1/2*1" S/COLOR	6,3800	172
67022	MACHON REDUCIDO M-M 2"*3/4 S/COLOR	7,1200	172
67023	MACHON REDUCIDO M-M 2"*1" S/COLOR	7,1200	172
67024	MACHON REDUCIDO M-M 2"*1"1/4 S/COLOR	9,8900	172
67025	MACHON REDUCIDO M-M 2"1/2*2" S/COLOR	17,9500	172
67026	MACHON REDUCIDO M-M 3"*2" S/COLOR	22,9300	172
67027	MACHON REDUCIDO M-M 3"*2"1/2 S/COLOR	26,1500	172
67028	MACHON REDUCIDO M 1/4 - M 1/8 *S/COLOR	0,6900	172
67029	MACHON REDUCIDO M-M 1/2*1/4 S/COLOR	1,5400	172
67030	MACHON REDUCIDO M-M 1 1/4*1/2 S/COLOR	4,7600	172
67031	MACHON REDUCIDO M-M 4"*2 1/2 S/COLOR	73,8100	172
67032	MACHON REDUCIDO M-M 4"*3" S/COLOR	84,2300	172
67033	MACHON REDUCIDO M-M 3/4*7/8 S/COLOR	2,2800	172
65001	MACHON CON TUERCA Y BICONO CORTO NIQUEL 1/2*3/8	1,8000	173
65002	MACHON MONOBLOC LARGO DE 32 mm NIQUEL 1/2*3/8	2,3800	173
65502	MACHON MONOBLOC LARGO DE 32 mm NIQUEL 1/2*3/8	2,7500	173
65507	MACHON MONOBLOC MEDIA ROSCA LARGO 40mm SU COLOR 1/2*3/8	1,3600	173
65508	MACHON MONOBLOC MEDIA ROSCA LARGO 40 mm NIQUEL 1/2*3/8	1,5500	173
67010	MACHON REDUCIDO M-M 1/2*3/8 NIQUEL	1,0500	173
67011	MACHON REDUCIDO M-M 3/4*1/2 NIQUEL	1,8500	173
67012	MACHON REDUCIDO M-M 1"*3/4 NIQUEL	2,5400	173
67041	MACHON REDUCIDO M-M 1"1/4 *1" NIQUEL	3,8800	173
67042	MACHON REDUCIDO M-M 1"1/2 *1"1/4 NIQUEL	5,6500	173
67043	MACHON REDUCIDO M-M 2"*1"1/2 NIQUEL	8,8000	173
67044	MACHON REDUCIDO M-M 1" x 1/2 NIQUEL	2,2100	173
67045	MACHON REDUCIDO M-M 1"1/2*1/2 NIQUEL	4,8600	173
67046	MACHON REDUCIDO M-M 1"1/4*1/2 NIQUEL	3,9800	173
67047	MACHON REDUCIDO M-M 1"1/4*3/4 NIQUEL	3,7000	173
67048	MACHON REDUCIDO M-M 1"1/2 *3/4 NIQUEL	4,8900	173
67049	MACHON REDUCIDO M-M 1"1/2 *1" NIQUEL	6,6200	173
67050	MACHON REDUCIDO M-M 2" *3/4 NIQUEL	7,9800	173
67051	MACHON REDUCIDO M-M 2"*1" NIQUEL	7,9800	173
67052	MACHON REDUCIDO M-M 2"*1"1/4 NIQUEL	8,5600	173
67053	MACHON REDUCIDO M-M 2"1/2*2" NIQUEL	14,6700	173
68001	MARSELLA HEXAGONAL M-H S/COLOR 3/8 x 10 mm	0,9000	174
68002	MARSELLA HEXAGONAL M-H S/COLOR 1/2 x 10 mm	1,0400	174
68003	MARSELLA HEXAGONAL M-H S/COLOR 1/2 x 20 mm	1,5000	174
68004	MARSELLA HEXAGONAL M-H S/COLOR 3/4 x 10 mm	1,9900	174
68005	MARSELLA HEXAGONAL M-H S/COLOR 1"	2,1200	174
68006	MARSELLA HEXAGONAL M-H S/COLOR 1"1/4	4,9700	174
68007	MARSELLA HEXAGONAL M-H S/COLOR 1"1/2	5,9900	174
68008	MARSELLA HEXAGONAL M-H S/COLOR 2"	14,3500	174
68009	MARSELLA HEXAGONAL M-H S/COLOR 1/2 x 30 mm	1,7900	174
68010	MARSELLA HEXAGONAL M-H NIQUEL 3/8 x 10 mm	1,3000	174
68011	MARSELLA HEXAGONAL M-H NIQUEL 1/2 x 10 mm	1,2700	174
68012	MARSELLA HEXAGONAL M-H NIQUEL 1/2 x 20 mm	1,6900	174
68013	MARSELLA HEXAGONAL M-H NIQUEL 3/4	2,2300	174
68014	MARSELLA HEXAGONAL M-H NIQUEL 1"	2,4500	174
68016	MARSELLA HEXAGONAL HEXAGONO INTERIOR S/COLOR 1/2	1,3300	174
69001	MARSELLA REDUCIDA HEXAGONAL S/COLOR M3/8 x H1/2	0,9900	174
69002	MARSELLA REDUCIDA HEXAGONAL S/COLOR M1/2 x H3/8	1,6000	174
69003	MARSELLA REDUCIDA HEXAGONAL S/COLOR M1/2 x H3/4	1,8300	174
69004	MARSELLA REDUCIDA HEXAGONAL S/COLOR M3/4 x H1/2	2,0900	174



69005	MARSELLA REDUCIDA HEXAGONAL S/COLOR M 3/4 x H1"	2,8400	174
69006	MARSELLA REDUCIDA HEXAGONAL S/COLOR M1" x H3/4	4,3500	174
69007	MARSELLA REDUCIDA HEXAGONAL S/COLOR M 1" x H1"1/4	6,5600	174
69008	MARSELLA REDUCIDA HEXAGONAL S/COLOR M 2" x H 2 1/2	23,3600	174
69009	MARSELLA REDUCIDA HEXAGONAL S/COLOR M 1" x H 1 1/2	7,7600	174
69010	MARSELLA REDUCIDA HEXAGONAL NIQUEL M3/8 x H1/2	1,0900	174
69011	MARSELLA REDUCIDA HEXAGONAL NIQUEL M1/2 x H3/8	0,9400	174
69012	MARSELLA REDUCIDA HEXAGONAL NIQUEL M1/2 x H3/4	1,8800	174
69013	MARSELLA REDUCIDA HEXAGONAL NIQUEL M3/4 x H1/2	2,0500	174
69014	MARSELLA REDUCIDA HEXAGONAL NIQUEL M3/4 x H1"	3,1400	174
69015	MARSELLA REDUCIDA HEXAGONAL NIQUEL M1" x H3/4	4,2800	174
69016	MARSELLA REDUCIDA HEXAGONAL S/COLOR M 1"1/4 x H1"1/2	6,6000	174
69017	MARSELLA REDUCIDA HEXAGONAL S/COLOR M 3/4 x H 1 1/4	4,4800	174
69018	MARSELLA REDUCIDA HEXAGONAL S/COLOR M 1/2 x H 1 1/4	6,5000	174
69019	MARSELLA REDUCIDA HEXAGONAL S/COLOR M 3/4 x H 2"	14,4500	174
69020	MARSELLA REDUCIDA HEXAGONAL S/COLOR M 3/8 x H 3/4	2,8300	174
69022	MARSELLA REDUCIDA HEXAGONAL S/COLOR M 1" x H 2"	13,6500	174
69023	MARSELLA REDUCIDA HEXAGONAL S/COLOR M1/8 x H1/4	1,9700	174
69024	MARSELLA REDUCIDA HEXAGONAL S/COLOR M 1" x H 1/2	2,9900	174
90092	MARSELLA REDUCIDA HEXAGONAL S/COLOR M 1 1/4 x H 2"	13,6000	174
98023	MARSELLA REDUCIDA HEXAGONAL S/COLOR M 1/2 x H 1"	2,2200	174
99228	MARSELLA REDUCIDA HEXAGONAL S/COLOR M 1"1/2 x H 2"	13,8900	174
64000	REDUCCION CON HEXAGONO S/COLOR 3/8*1/4	0,6500	175
64001	REDUCCION CON HEXAGONO S/COLOR 1/2*1/4	1,1000	175
64002	REDUCCION CON HEXAGONO S/COLOR 1/2*3/8	0,8600	175
64003	REDUCCION CON HEXAGONO S/COLOR 3/4*1/2	1,3600	175
64004	REDUCCION CON HEXAGONO S/COLOR 1"*1/2	2,7200	175
64005	REDUCCION CON HEXAGONO S/COLOR 1"*3/4	1,9200	175
64006	REDUCCION CON HEXAGONO S/COLOR 1"1/4*3/4	4,3500	175
64007	REDUCCION CON HEXAGONO S/COLOR 1"1/4*1"	2,9900	175
64008	REDUCCION CON HEXAGONO S/COLOR 1"1/2 *3/4	5,7300	175
64009	REDUCCION CON HEXAGONO S/COLOR 1"1/2 *1"	4,9700	175
64010	REDUCCION CON HEXAGONO S/COLOR 1"1/2 *1"1/4	3,3500	175
64011	REDUCCION CON HEXAGONO S/COLOR 2"*3/4	8,6800	175
64012	REDUCCION CON HEXAGONO S/COLOR 2" *1"	8,6700	175
64013	REDUCCION CON HEXAGONO S/COLOR 2" *1"1/4	8,4800	175
64014	REDUCCION CON HEXAGONO S/COLOR 2" *1"1/2	7,3100	175
64015	REDUCCION CON HEXAGONO S/COLOR 2"1/2 * 2"	18,9200	175
64016	REDUCCION CON HEXAGONO S/COLOR 3" * 2"	23,9600	175
64017	REDUCCION CON HEXAGONO S/COLOR 3" * 2"1/2	23,9600	175
64019	REDUCCION CON HEXAGONO S/COLOR 2"* 1/2	5,9600	175
64020	REDUCCION OCULTA S/COLOR 3/8 *1/4	0,8000	175
64021	REDUCCION OCULTA S/COLOR 1/2 * 3/8	0,6900	175
64022	REDUCCION OCULTA S/COLOR 3/4 * 1/2	1,8600	175
64023	REDUCCION OCULTA S/COLOR 1" * 3/4	1,4100	175
64024	REDUCCION CON HEXAGONO S/COLOR 1/2 * 1/8	1,5600	175
64025	REDUCCION CON HEXAGONO S/COLOR 1 1/2 * 1/2	4,3500	175
64027	REDUCCION CON HEXAGONO S/COLOR 1 1/4 * 1/2	4,0800	175
64028	REDUCCION CON HEXAGONO S/COLOR 4" * 2 1/2	60,5400	175
64029	REDUCCION CON HEXAGONO S/COLOR 4" * 3"	69,5900	175
64030	REDUCCION CON HEXAGONO S/COLOR 2 1/2 * 3/4	18,9300	175
64031	REDUCCION CON HEXAGONO S/COLOR 2 1/2 * 1"	18,9300	175
64033	REDUCCION CON HEXAGONO S/COLOR 2 1/2 * 1 1/4	18,9300	175
64034	REDUCCION CON HEXAGONO S/COLOR 2 1/2 * 1 1/2	20,7500	175



64035	REDUCCION CON HEXAGONO S/COLOR 3" * 1 1/4	28,7200	175
64037	REDUCCION CON HEXAGONO S/COLOR 4" * 2"	60,5400	175
64041	REDUCCION OCULTA S/COLOR 1" x 1/2	2,4500	175
64042	REDUCCION OCULTA S/COLOR 7/8 x 3/4 x 13,5 mm	1,4300	175
99091	REDUCCION CON HEXAGONO 1/4x1/8	0,6200	175
46001	CODO LATON ROSCAR H-H 1/4	2,1500	176
46002	CODO LATON ROSCAR H-H 3/8	2,1900	176
46003	CODO LATON ROSCAR H-H 1/2	2,5700	176
46004	CODO LATON ROSCAR H-H 3/4	3,5700	176
46005	CODO LATON ROSCAR H-H 1"	4,9800	176
46006	CODO LATON ROSCAR H-H 1"1/4	8,9200	176
46007	CODO LATON ROSCAR H-H1"1/2	11,7500	176
46008	CODO LATON ROSCAR H-H 2"	19,9300	176
46009	CODO LATON ROSCAR H-H 2"1/2	34,9500	176
46010	CODO LATON ROSCAR H-H 3"	54,2300	176
46011	CODO LATON ROSCAR H-H 4"	126,1500	176
46012	CODO LATON ROSCAR NIQUEL H-H 3/8	2,2600	176
46013	CODO LATON ROSCAR NIQUEL H-H 1/2	3,0500	176
46014	CODO LATON ROSCAR NIQUEL H-H 3/4	3,9900	176
46015	CODO LATON ROSCAR NIQUEL H-H 1"	5,1600	176
46032	CODO LATON REDUCIDO ROSCAR H-H 3/8*1/2	1,9800	176
46033	CODO LATON REDUCIDO ROSCAR H-H1/2*3/4	1,9900	176
46034	CODO LATON REDUCIDO ROSCAR H-H 3/4*1"	2,8600	176
46035	CODO LATON REDUCIDO ROSCAR H-H 1"*1/2	3,1800	176
46037	CODO LATON REDUCIDO ROSCAR NIQUEL H-H 3/8*1/2	2,6000	176
46038	CODO LATON REDUCIDO ROSCAR NIQUEL H-H 1/2*3/4	2,8000	176
46039	CODO LATON REDUCIDO ROSCAR NIQUEL H-H 3/4*1"	3,7000	176
47002	CODO LATON ROSCAR M-H 3/8	1,5600	177
47003	CODO LATON ROSCAR M-H 1/2	1,9900	177
47004	CODO LATON ROSCAR M-H 3/4	3,5800	177
47005	CODO LATON ROSCAR M-H 1"	5,3000	177
47006	CODO LATON ROSCAR M-H 1 1/4	9,8800	177
47007	CODO LATON ROSCAR M-H 1 1/2	11,8100	177
47008	CODO LATON ROSCAR M-H 2"	16,9800	177
47009	CODO LATON ROSCAR M-H 2"1/2	36,6600	177
47010	CODO LATON ROSCAR M-H 3"	65,5200	177
47011	CODO LATON ROSCAR M-H 4"	129,3300	177
47012	CODO LATON ROSCAR NIQUEL M-H 3/8	1,7900	177
47013	CODO LATON ROSCAR NIQUEL M-H 1/2	2,1600	177
47014	CODO LATON ROSCAR NIQUEL M-H 3/4	4,6300	177
47015	CODO LATON ROSCAR NIQUEL M-H 1"	4,5600	177
47032	CODO LATON REDUCIDO ROSCAR M1/2-H 3/4	3,7900	177
47033	CODO LATON REDUCIDO ROSCAR M3/4 -H 1"	7,0800	177
47034	CODO LATON REDUCIDO ROSCAR M 1"-H 1" 1/4	13,2800	177
47037	CODO LATON REDUCIDO ROSCAR M-1/2-H 3/4 NIQUEL	4,1100	177
47038	CODO LATON REDUCIDO ROSCAR M3/4-H 1" NIQUEL	7,6200	177
47039	CODO LATON REDUCIDO ROSCAR M-H 1" X 1 1/4 NIQUEL	14,9800	177
45001	TE LATON ROSCAR H*H*H 1/4	2,6800	178
45002	TE LATON ROSCAR H*H*H 3/8	1,8900	178
45003	TE LATON ROSCAR H*H*H 1/2	2,8200	178
45004	TE LATON ROSCAR H*H*H 3/4	3,6300	178
45005	TE LATON ROSCAR H*H*H 1"	5,8800	178
45006	TE LATON ROSCAR H*H*H 1"1/4	11,8600	178
45007	TE LATON ROSCAR H*H*H 1"1/2	15,6800	178



45008	TE LATON ROSCAR H*H*H 2"	23,1500	178
45009	TE LATON ROSCAR H*H*H 2"1/2	39,6900	178
45010	TE LATON ROSCAR H*H*H 3"	72,2000	178
45011	TE LATON ROSCAR H*H*H 4"	116,7400	178
45012	TE LATON ROSCAR NIQUEL H*H*H 3/8	1,8900	178
45013	TE LATON ROSCAR NIQUEL H*H*H 1/2	3,9500	178
45014	TE LATON ROSCAR NIQUEL H*H*H 3/4	4,0500	178
45015	TE LATON ROSCAR NIQUEL H*H*H 1"	6,5800	178
45016	TE LATON REDUCIDA ROSCAR H*H*H 3/4-1/2-3/4	2,9000	178
45017	TE LATON REDUCIDA ROSCAR H*H*H 1"-3/4-1"	4,1600	178
45018	TE LATON REDUCIDA ROSCAR H*H*H 1"-1/2-1"	3,9800	178
45019	TE LATON REDUCIDA ROSCAR H-H-H 1 1/4 x 1/2 x 1 1/4	6,9800	178
45020	TE LATON REDUCIDA ROSCAR H-H-H 1"1/4 X 3/4 X 1"1/4	10,5100	178
45021	TE LATON REDUCIDA ROSCAR H-H-H-3/4-3/4-1/2	6,1500	178
45024	TE LATON REDUCIDA ROSCAR H-H-H 1"1/2 X 1"X 1"1/2	8,7400	178
45027	TE LATON REDUCIDA ROSCAR H-H-H 1"1/2 X 1"1/4 X 1"1/2	8,7500	178
45032	TE LATON REDUCIDA ROSCAR H-H-H- 1 1/2 X 1/2 X 1 1/2	12,9300	178
45033	TE LATON REDUCIDA ROSCAR H-H-H 2" X 1"1/4 X 2"	14,9700	178
45034	TE LATON REDUCIDA ROSCAR H-H-H 2" X 1"1/2 X 2"	14,9700	178
45035	TE LATON REDUCIDA ROSCAR H-H-H- 1 1/2 X 3/4 X 1 1/2	8,7500	178
45036	TE LATON REDUCIDA ROSCAR H-H-H- 2" X 3/4 X 2"	14,9700	178
45037	TE LATON REDUCIDA ROSCAR H-H-H 1 1/4 x 1"x 1 1/4	7,1800	178
48001	MANGUITO LATON ROSCAR H-H 1/4	2,4100	179
48002	MANGUITO LATON ROSCAR H-H 3/8	1,6400	179
48003	MANGUITO LATON ROSCAR H-H 1/2	1,9500	179
48004	MANGUITO LATON ROSCAR H-H 3/4	1,9800	179
48005	MANGUITO LATON ROSCAR H-H 1"	3,9900	179
48006	MANGUITO LATON ROSCAR H-H 1 1/4	5,0500	179
48007	MANGUITO LATON ROSCAR H-H 1 1/2	8,2200	179
48008	MANGUITO LATON ROSCAR H-H 2"	12,1500	179
48009	MANGUITO LATON ROSCAR H-H 2" 1/2	22,9900	179
48010	MANGUITO LATON ROSCAR H-H 3"	29,9700	179
48011	MANGUITO LATON ROSCAR H-H 4"	83,8000	179
48012	MANGUITO LATON ROSCAR NIQUEL H-H 3/8	1,4300	179
48013	MANGUITO LATON ROSCAR NIQUEL H-H 1/2	2,1800	179
48014	MANGUITO LATON ROSCAR NIQUEL H-H 3/4	2,2600	179
48015	MANGUITO LATON ROSCAR NIQUEL H-H 1"	5,1000	179
48017	MANGUITO LATON REDUCIDO ROSCAR H-H 3/8*1/2	1,7200	179
48018	MANGUITO LATON REDUCIDO ROSCAR H-H 1/2*3/4	2,5300	179
48019	MANGUITO LATON REDUCIDO ROSCAR H-H 3/4*1"	3,7500	179
48020	MANGUITO LATON REDUCIDO ROSCAR H-H 1"*1"1/4	3,9900	179
48021	MANGUITO LATON REDUCIDO ROSCAR H-H 1"1/4*1"1/2	4,8500	179
48022	MANGUITO LATON REDUCIDO ROSCAR H-H 1"1/2 * 2"	11,6400	179
48023	MANGUITO LATON REDUCIDO ROSCAR H-H 1"1/4 * 2"	7,3600	179
48024	MANGUITO LATON REDUCIDO ROSCAR H-H 1"*2"	6,9100	179
48025	MANGUITO LATON REDUCIDO H-H 2 1/2 * 2"	15,6600	179
48026	MANGUITO LATON REDUCIDO ROSCAR NIQUEL H-H 3/8 x 1/2	1,7000	179
48027	MANGUITO LATON REDUCIDO ROSCAR NIQUEL H-H 1/2x3/4	2,2500	179
48028	MANGUITO LATON REDUCIDO ROSCAR NIQUEL H-H 3/4*1"	3,2200	179
48029	MANGUITO LATON REDUCIDO H-H 3"*2"	45,4900	179
48065	MANGUITO LATON REDUCIDO ROSCAR H-H 1/2 x 1"	3,9900	179
70000	TAPON LATON HEMBRA 1/8	0,3600	180
70001	TAPON LATON HEMBRA 1/4	0,5000	180
70002	TAPON LATON HEMBRA 3/8	0,6300	180



70003	TAPON LATON HEMBRA 1/2	0,6100	180
70004	TAPON LATON HEMBRA 3/4	1,0500	180
70005	TAPON LATON HEMBRA 1"	1,5800	180
70006	TAPON LATON HEMBRA 1"1/4	3,9200	180
70007	TAPON LATON HEMBRA 1"1/2	5,4800	180
70008	TAPON LATON HEMBRA 2"	5,2200	180
70009	TAPON LATON HEMBRA 2 1/2	19,6400	180
70010	TAPON LATON HEMBRA 3"	28,2500	180
70011	TAPON LATON HEMBRA 4"	59,0500	180
70014	TAPON LATON HEMBRA 1/2 CON PRECINTO	0,9000	180
70015	TAPON LATON HEMBRA 3/4 CON PRECINTO	1,2500	180
70016	TAPON LATON HEMBRA 1" CON PRECINTO	1,7800	180
70017	TAPON LATON HEMBRA 7/8 CON PRECINTO	2,5100	180
70018	TAPON LATON HEMBRA 3/8 NIQUEL	0,4900	180
70019	TAPON LATON HEMBRA 1/2 NIQUEL	0,7400	180
70020	TAPON LATON HEMBRA 3/4 NIQUEL	1,3300	180
70021	TAPON LATON HEMBRA 1" NIQUEL	1,0500	180
70500	TAPON LATON MACHO 1/8	0,6000	181
70501	TAPON LATON MACHO 1/4	0,5200	181
70502	TAPON LATON MACHO 3/8	0,7600	181
70503	TAPON LATON MACHO 1/2	0,9400	181
70504	TAPON LATON MACHO 3/4	1,3500	181
70505	TAPON LATON MACHO 1"	2,4400	181
70506	TAPON LATON MACHO 1"1/4	3,7000	181
70507	TAPON LATON MACHO 1"1/2	4,1500	181
70508	TAPON LATON MACHO 2"	7,2900	181
70509	TAPON LATON MACHO DE 2 1/2	15,1700	181
70510	TAPON LATON MACHO DE 3"	28,7500	181
70511	TAPON LATON MACHO DE 4"	60,2000	181
70512	TAPON LATON MACHO 3/8 NIQUEL	0,7700	181
70513	TAPON LATON MACHO 1/2 NIQUEL	1,0500	181
70514	TAPON LATON MACHO 3/4 NIQUEL	1,1100	181
70515	TAPON LATON MACHO CON PRECINTO DE 1/2	0,9900	181
70516	TAPON LATON MACHO CON PRECINTO DE 3/4	2,3800	181
70518	TAPON LATON MACHO CON PRECINTO 1"	2,2600	181
70519	TAPON LATON MACHO 7/8 CON PRECINTO	3,2500	181
70520	TAPON LATON MACHO 1" NIQUEL	1,9400	181
69501	UNION TRES PIEZAS CIERRE CONICO H*H-1/2	6,8500	182
69502	UNION TRES PIEZAS CIERRE CONICO H*H-3/4	9,1800	182
69503	UNION TRES PIEZAS CIERRE CONICO H*H-1"	11,7500	182
69504	UNION TRES PIEZAS CIERRE CONICO H*H-1"1/4	17,9000	182
69505	UNION TRES PIEZAS CIERRE CONICO H*H-1"1/2	21,7900	182
69506	UNION TRES PIEZAS CIERRE CONICO H*H-2"	27,0200	182
69507	UNION TRES PIEZAS CIERRE CONICO H*H-2"1/2	76,2000	182
69508	UNION TRES PIEZAS CIERRE CONICO H*H-3"	99,9800	182
69509	UNION TRES PIEZAS CIERRE CONICO H*H-4"	298,0800	182
69510	UNION TRES PIEZAS CIERRE CONICO M*H-1/2	4,9500	182
69511	UNION TRES PIEZAS CIERRE CONICO M*H-3/4	8,2100	182
69512	UNION TRES PIEZAS CIERRE CONICO M*H-1"	14,6800	182
69513	UNION TRES PIEZAS CIERRE CONICO M*H-1"1/4	18,6500	182
69514	UNION TRES PIEZAS CIERRE CONICO M*H-1"1/2	25,9700	182
69515	UNION TRES PIEZAS CIERRE CONICO M*H-2"	35,9100	182
69516	UNION TRES PIEZAS CIERRE CONICO M*H 2 1/2	99,1000	182
69581	UNION TRES PIEZAS CIERRE JUNTA PLANA H*H 1/2	4,7900	182



69582	UNION TRES PIEZAS CIERRE JUNTA PLANA H*H 3/4	7,1500	182
69583	UNION TRES PIEZAS CIERRE JUNTA PLANA H*H 1"	16,7300	182
69584	UNION TRES PIEZAS CIERRE JUNTA PLANA H*H 1 1/4	17,6800	182
69585	UNION TRES PIEZAS CIERRE JUNTA PLANA H*H 1 1/2	30,3600	182
69586	UNION TRES PIEZAS CIERRE JUNTA PLANA H*H 2"	28,2400	182
69591	UNION TRES PIEZAS CIERRE JUNTA PLANA M*H 1/2	5,3300	182
69592	UNION TRES PIEZAS CIERRE JUNTA PLANA M*H 3/4	8,5500	182
69593	UNION TRES PIEZAS CIERRE JUNTA PLANA M*H 1"	14,4900	182
69594	UNION TRES PIEZAS CIERRE JUNTA PLANA M*H 1 1/4	25,0600	182
69595	UNION TRES PIEZAS CIERRE JUNTA PLANA M*H 1 1/2	31,5900	182
69596	UNION TRES PIEZAS CIERRE JUNTA PLANA M*H 2"	53,7900	182
59402	RACOR DEPOSITO URALITA CON TUERCA CORREDERA 3/8	1,9600	183
59403	RACOR DEPOSITO URALITA CON TUERCA CORREDERA 1/2	2,7000	183
59404	RACOR DEPOSITO URALITA CON TUERCA CORREDERA 3/4	4,5500	183
59405	RACOR DEPOSITO URALITA CON TUERCA CORREDERA 1"	6,1000	183
59406	RACOR DEPOSITO URALITA CON TUERCA CORREDERA 1"1/4	10,2200	183
59407	RACOR DEPOSITO URALITA CON TUERCA CORREDERA 1"1/2	13,5000	183
59408	RACOR DEPOSITO URALITA CON TUERCA CORREDERA 2"	16,1500	183
59409	RACOR DEPOSITO URALITA CON TUERCA CORREDERA 2"1/2	52,5300	183
59410	RACOR DEPOSITO URALITA CON TUERCA CORREDERA 3"	79,8500	183
59603	RACOR DEPOSITO URALITA CON TUERCA Y TUBO 1/2	3,7000	183
59604	RACOR DEPOSITO URALITA CON TUERCA Y TUBO 3/4	5,7100	183
59605	RACOR DEPOSITO URALITA CON TUERCA Y TUBO 1"	8,0800	183
59606	RACOR DEPOSITO URALITA CON TUERCA Y TUBO 1"1/4	12,7000	183
59607	RACOR DEPOSITO URALITA CON TUERCA Y TUBO 1"1/2	17,3700	183
59608	RACOR DEPOSITO URALITA CON TUERCA Y TUBO 2"	28,5100	183
59609	RACOR DEPOSITO URALITA CON TUERCA Y TUBO 2"1/2	68,9900	183
59610	RACOR DEPOSITO URALITA CON TUERCA Y TUBO 3"	125,1000	183
59615	ARANDELA RACOR DEPOSITO ZINCADA 3/8 x 38	0,2400	183
59616	ARANDELA RACOR DEPOSITO ZINCADA 1/2 x 45	0,1800	183
59617	ARANDELA RACOR DEPOSITO ZINCADA 3/4 x 55	0,2200	183
59618	ARANDELA RACOR DEPOSITO ZINCADA 1" x 66	0,2400	183
59619	ARANDELA RACOR DEPOSITO ZINCADA 1"1/4 x 66	0,4500	183
59620	ARANDELA RACOR DEPOSITO ZINCADA 1"1/2 x 78	0,4700	183
59621	ARANDELA RACOR DEPOSITO ZINCADA 2" x 88	0,5900	183
59625	ARANDELA RACOR DEPOSITO LATON 1/2 x 43	1,2300	183
59626	ARANDELA RACOR DEPOSITO LATON 3/4 x 53	1,4500	183
59627	ARANDELA RACOR DEPOSITO LATON 1"x 66	1,9900	183
59628	ARANDELA RACOR DEPOSITO LATON 1"1/4 x 72	2,6000	183
59629	ARANDELA RACOR DEPOSITO LATON 1"1/2 x 78	2,7800	183
59630	ARANDELA RACOR DEPOSITO LATON 2 x 88	3,4800	183
59634	ARANDELA RACOR DEPOSITO ACERO INOX. 3/8 x 38	0,3200	183
59635	ARANDELA RACOR DEPOSITO ACERO INOX. 1/2 x 43	0,4500	183
59636	ARANDELA RACOR DEPOSITO ACERO INOX. 3/4 x 53	0,5500	183
59637	ARANDELA RACOR DEPOSITO ACERO INOX. 1"x 66	0,6000	183
59638	ARANDELA RACOR DEPOSITO ACERO INOX. 1"1/4 x 72	1,1500	183
59639	ARANDELA RACOR DEPOSITO ACERO INOX. 1"1/2 x 78	1,2200	183
59640	ARANDELA RACOR DEPOSITO ACERO INOX. 2 x 88	1,3500	183
58900	ALARGADERA CILINDRICA MH S/COLOR 3/8*30	1,9800	184
58901	ALARGADERA CILINDRICA MH S/COLOR 3/8*50	2,9500	184
58902	ALARGADERA CILINDRICA MH S/COLOR 3/8*100	6,8200	184
59001	ALARGADERA CILINDRICA MH S/COLOR 1/2*10	1,2500	184
59002	ALARGADERA CILINDRICA MH S/COLOR 1/2*20	2,7100	184
59003	ALARGADERA CILINDRICA MH S/COLOR 1/2*30	1,9800	184



59004	ALARGADERA CILINDRICA MH S/COLOR 1/2*50	2,3800	184
59005	ALARGADERA CILINDRICA MH S/COLOR 1/2*100	3,6500	184
59006	ALARGADERA CILINDRICA MH S/COLOR 1/2*40	2,8700	184
59008	ALARGADERA CILINDRICA MH S/COLOR 1/2 *60	6,5300	184
59009	ALARGADERA CILINDRICA MH S/COLOR 1/2 *70	5,1600	184
59010	ALARGADERA CILINDRICA MH S/COLOR 1/2 *80	8,1900	184
59011	ALARGADERA CILINDRICA MH S/COLOR 3/4*50	4,4000	184
59012	ALARGADERA CILINDRICA MH S/COLOR 3/4*100	7,2200	184
59100	ALARGADERA CILINDRICA MH NIQUEL 3/8*30	2,3000	184
59101	ALARGADERA CILINDRICA MH CROMO 3/8*50	4,1500	184
59102	ALARGADERA CILINDRICA MH NIQUEL 3/8*100	5,4900	184
59201	ALARGADERA CILINDRICA MH-CROMO 1/2*10	2,1000	184
59202	ALARGADERA CILINDRICA MH-CROMO 1/2*20	2,6200	184
59203	ALARGADERA CILINDRICA MH-CROMO 1/2*30	2,8800	184
59204	ALARGADERA CILINDRICA MH-CROMO 1/2*50	2,9300	184
59205	ALARGADERA CILINDRICA MH CROMO 1/2*100	3,8500	184
59206	ALARGADERA CILINDRICA MH-CROMO 1/2*40	3,9900	184
59208	ALARGADERA CILINDRICA MH CROMO 1/2*60	6,6700	184
59209	ALARGADERA CILINDRICA MH CROMO 1/2*70	5,4800	184
59210	ALARGADERA CILINDRICA MH CROMO 1/2*80	8,2500	184
59211	ALARGADERA CILINDRICA MH CROMO 3/4*50	3,9600	184
59212	ALARGADERA CILINDRICA MH CROMO 3/4*100	6,5000	184
69519	TUERCA CORREDERA C/VALONA 3/8	0,4800	184
69520	TUERCA CORREDERA C/VALONA 1/2	0,5900	184
69521	TUERCA CORREDERA C/VALONA 3/4	0,8900	184
69522	TUERCA CORREDERA C/VALONA 1"	0,8800	184
69523	TUERCA CORREDERA C/VALONA 1"1/4	1,6500	184
69524	TUERCA CORREDERA C/VALONA 1"1/2	2,2400	184
69525	TUERCA CORREDERA C/VALONA 2"	6,2700	184
69526	TUERCA CORREDERA C/VALONA 2"1/2	9,6300	184
69527	TUERCA CORREDERA C/VALONA 3"	12,2200	184
99329	TUERCA CORREDERA CON VALONA 28/150 HEX.32	0,8000	184
46016	CODO TRES BOCAS ROSCAR H-H-H*1/2	3,7800	185
46017	CODO TRES BOCAS ROSCAR H-H-H*3/4	6,5200	185
47016	CURVA LATON ROSCAR M*H 1/2 (TH-1)	6,6200	185
47017	CURVA LATON ROSCAR M*H 3/4 (TH-1)	6,7500	185
47018	CURVA LATON ROSCAR M*H 1"(TH-1)	8,9900	185
47019	CURVA LATON ROSCAR M*H 1 1/4 (TH-1)	14,9800	185
47020	CURVA LATON ROSCAR M*H 1 1/2 (TH-1)	18,1500	185
47021	CURVA LATON ROSCAR M*H 2"(TH-1)	29,9800	185
47022	CURVA LATON ROSCAR H*H 1/2 (TH-2)	4,2500	185
47023	CURVA LATON ROSCAR H*H 3/4 (TH-2)	6,7500	185
47024	CURVA LATON ROSCAR H*H 1"(TH-2)	13,2000	185
47025	CURVA LATON ROSCAR H*H 1 1/4 (TH-2)	24,5600	185
47026	CURVA LATON ROSCAR H*H 1 1/2 (TH-2)	19,7500	185
47027	CURVA LATON ROSCAR H*H 2" (TH-2)	48,0500	185
47028	CURVA LATON ROSCAR H*H 2 1/2 (TH-2)	53,1000	185
47029	CURVA LATON ROSCAR H*H 3" (TH-2)	132,6200	185
47101	VALVULA 5 VIAS 1" x 1" x 1" x 1/4 x 81mm	6,9600	185
47102	VALVULA 5 VIAS 1" x 1" x 1"x 1/4 x 92 mm	10,6800	185
47103	VALVULA 5 VIAS 1" x 1"x 1" x 1/4 x 120 mm	15,4800	185
48501	CRUZ LATON ROSCAR H-3/8	2,6200	185
48502	CRUZ LATON ROSCAR H-1/2	5,8300	185
48503	CRUZ LATON ROSCAR H-3/4	7,5800	185



48504	CRUZ LATON ROSCAR H-1"	11,5500	185
48505	CRUZ LATON ROSCAR H-1"1/4	16,9900	185
48506	CRUZ LATON ROSCAR H-1"1/2	21,8200	185
48507	CRUZ LATON ROSCAR H-2"	33,7600	185
48508	CRUZ LATON ROSCAR H-2"1/2	152,3700	185
48509	CRUZ LATON ROSCAR H-3"	144,5000	185
99354	BEBEDERO CERDO LATON DE 1/2	4,1000	185
48030	COLLARIN CON TOMA LATON 20*1/2	9,9300	186
48031	COLLARIN CON TOMA LATON 25x1/2	9,9300	186
48032	COLLARIN CON TOMA LATON 32*1/2	13,6000	186
48033	COLLARIN CON TOMA LATON 40x1/2	21,1000	186
48034	COLLARIN CON TOMA LATON 50*1/2	20,4500	186
48035	COLLARIN CON TOMA LATON 63*1/2	15,9800	186
48036	COLLARIN CON TOMA LATON 75*1/2	28,8600	186
48037	COLLARIN CON TOMA LATON 90*1/2	28,2900	186
48038	COLLARIN CON TOMA LATON 40*3/4	20,3700	186
48039	COLLARIN CON TOMA LATON 50*3/4	20,5500	186
48040	COLLARIN CON TOMA LATON 63*3/4	33,4500	186
48041	COLLARIN CON TOMA LATON 75*3/4	30,0500	186
48042	COLLARIN CON TOMA LATON 90*3/4	28,1600	186
48043	COLLARIN CON TOMA LATON 63*1"	34,2500	186
48044	COLLARIN CON TOMA LATON 75x1"	27,5200	186
48045	COLLARIN CON TOMA LATON 90*1"	28,9100	186
48050	COLLARIN CIEGO LATON 1/2*20	8,5500	186
48051	COLLARIN CIEGO LATON 3/4*25	9,5700	186
48052	COLLARIN CIEGO LATON 1"*32	13,7500	186
48053	COLLARIN CIEGO LATON 1"1/4*40	10,8800	186
48054	COLLARIN CIEGO LATON 1"1/2*50	24,4700	186
48055	COLLARIN CIEGO LATON 2"*63	28,3000	186
48056	COLLARIN CIEGO LATON 2"1/2*75	36,3800	186
48057	COLLARIN CIEGO LATON 3"*90	27,2500	186
72503	MANGUITO ELECTROLISIS H*H 1/2	2,4300	186
72504	MANGUITO ELECTROLISIS H*H 3/4	3,7500	186
72505	MANGUITO ELECTROLISIS H*H 1"	6,2500	186
72506	MANGUITO ELECTROLISIS H*H 1"1/4	13,2000	186
72507	MANGUITO ELECTROLISIS H*H 1"1/2	21,5600	186
72508	MANGUITO ELECTROLISIS H*H 2"	37,4000	186
72509	MANGUITO ELECTROLISIS H*H 2"1/2	46,9600	186
72510	MANGUITO ELECTROLISIS H*H 3"	96,0300	186
72514	MANGUITO ELECTROLISIS H*H 4"	90,1900	186
72601	MANGUITO ELECTROLISIS FIBRA DE VIDRIO M*H 1/2	1,6900	186
72602	MANGUITO ELECTROLISIS RECUBRIMIENTO COBRE M*H 1/2	2,5700	186
72603	MANGUITO ELECTROLISIS RECUBRIMIENTO COBRE M*H 3/4	4,2900	186

RACORERÍA DE LATÓN SOLDAR

REF.	DESCRIPCIÓN	PVP	PÁG.
49000	CODO HEMBRA-90 G-CU 2" * 54	21,3800	188
49001	CODO HEMBRA-90 G-CU 1/2*15	1,6200	188
49002	CODO HEMBRA-90 G-CU 1 1/4*35	22,3500	188
49003	CODO HEMBRA-90 G-CU 1/2*18	1,9200	188
49004	CODO HEMBRA-90 G-CU 3/4*18	2,8000	188
49005	CODO HEMBRA-90 G-CU 3/4*22	2,8100	188
49006	CODO HEMBRA-90 G-CU 1"*28	7,6200	188
49007	CODO HEMBRA-90-G-CU 3/8*15	1,2000	188



49008	CODO HEMBRA-90 G-CU-1/2*22	1,9200	188
49009	CODO HEMBRA-90 G-CU 3/4*15	2,7700	188
49010	CODO HEMBRA-90 G-CU 1*22	4,1600	188
49011	CODO HEMBRA-90 G-CU 1/2*12	1,9900	188
49012	CODO HEMBRA-90 G-CU 3/4*28	5,9500	188
49013	CODO HEMBRA-90 G-CU 1 1/4*28	8,0500	188
49014	CODO HEMBRA-90 G-CU 11/2 * 42	13,5400	188
49015	CODO MACHO-92 G-CU 1/2*15	1,8800	188
49016	CODO MACHO-92 G-CU 1/2*18	1,9500	188
49017	CODO MACHO-92 G-CU 1/2*22	1,9400	188
49018	CODO MACHO-92 G-CU 3/4*18	1,7200	188
49019	CODO MACHO-92 G-CU 3/4*22	2,5500	188
49020	CODO MACHO-92 G-CU 1"*28	5,2800	188
49026	CODO MACHO-92 G-CU 1/2*12	1,2800	188
49028	CODO HEMBRA-90 G-CU-1/2 *16	2,4500	188
49031	CODO MURAL-472 G-CU 1/2*15	2,8900	188
49032	CODO MURAL-472 G-CU 1/2*18	3,1800	188
49033	CODO MURAL-472 G-CU 3/4*22	5,2300	188
49034	CODO MURAL-472 G-CU 1"*28	12,5400	188
49035	CODO MURAL-472 G-CU 1/2* 12	3,9000	188
49037	CODO MURAL-472 G-CU 3/4*18	3,5700	188
49022	ENLACE HEMBRA-G-CU 270 1 1/2 *54	10,4200	189
49024	ENTRONQUE MACHO-243 G-CU 1/2*14	1,5500	189
49027	ENTRONQUE MACHO-243 G-CU 3/8*14	0,7000	189
49036	ENTRONQUE MACHO-243 G CU 3/8*15	0,5600	189
49039	ENTRONQUE MACHO-243 G CU 1"*35	4,3000	189
49052	ENTRONQUE MACHO-243 G-CU 3/8*10	0,6200	189
49054	ENTRONQUE MACHO-243 G-CU 1 1/2 *35	4,3500	189
49055	ENTRONQUE MACHO-243 G-CU 1/2*15	1,0500	189
49056	ENTRONQUE MACHO-243 G-CU 1/2*18	0,7200	189
49057	ENTRONQUE MACHO-243 G-CU 1/2*22	1,9900	189
49058	ENTRONQUE MACHO-243 G-CU 3/4*18	2,3400	189
49059	ENTRONQUE MACHO-243 G-CU 3/4*22	2,1900	189
49060	ENTRONQUE MACHO-243 G-CU 1"*28	3,5500	189
49061	ENTRONQUE MACHO-243 G-CU 1/2 *12	1,7500	189
49062	ENTRONQUE MACHO-243 G-CU 3/4 *15	1,3600	189
49063	ENTRONQUE MACHO-243 G CU 1 1/4 *28	4,2200	189
49064	ENTRONQUE MACHO-243 G CU 1 *22	3,3400	189
49065	ENTRONQUE MACHO-243 G-CU 1 1/4 *35	6,1300	189
49066	ENTRONQUE MACHO-243 G-CU 1 1/2 *42	4,6900	189
49067	ENTRONQUE MACHO-243 G-CU 3/4 *28	3,1000	189
49068	ENTRONQUE MACHO-243 G-CU 3/8 *12	0,6100	189
49069	ENTRONQUE MACHO-243 G-CU 2 1/2 *64	37,7000	189
49070	ENTRONQUE MACHO-243 G-CU 1 1/4 *42	3,9900	189
49071	ENLACE HEMBRA-270 G-CU 1/2*15	0,8000	189
49072	ENLACE HEMBRA-270 G-CU 1/2*18	1,1700	189
49073	ENLACE HEMBRA-270 G-CU 1/2*22	2,3100	189
49074	ENLACE HEMBRA-270 G-CU 3/4*18	1,9200	189
49075	ENLACE HEMBRA-270 G-CU 3/4*22	2,2800	189
49076	ENLACE HEMBRA-270 G-CU 1"*28	2,5600	189
49077	ENLACE HEMBRA-270 G-CU 1/2*10	0,9100	189
49078	ENLACE HEMBRA-270 G-CU 1/2 *12	1,2000	189
49079	ENLACE HEMBRA-270 G-CU 3/8 *15	0,7200	189
49080	ENLACE HEMBRA-270 G-CU 3/4 *15	1,4300	189



49081	ENLACE HEMBRA-270 G CU 1 1/4 *28	5,3900	189
49082	ENLACE HEMBRA-270 G-CU 1" *22	1,9900	189
49083	ENLACE HEMBRA-270 G-CU 1 1/4 *35	6,7900	189
49084	ENLACE HEMBRA-270 G-CU 3/4 *28	2,3200	189
49085	ENLACE HEMBRA-270 G-CU 3/8 *12	0,5700	189
49086	ENTRONQUE MACHO-243 G-CU 2" *54	7,5900	189
49087	ENLACE HEMBRA-270 G-CU 2" *54	19,9500	189
49088	ENLACE HEMBRA-270 G-CU 1 1/2 *42	6,9800	189
49089	ENTRONQUE MACHO-243 G-CU 3" *76	34,7000	189
49025	TE HEMBRA-130 G-CU 1 1/4*35	16,9300	190
49040	TE HEMBRA-130 G-CU 3/8*15	1,5800	190
49041	TE HEMBRA-130 G-CU 1/2*15	1,5900	190
49042	TE HEMBRA-130 G-CU 1/2*18	2,4400	190
49043	TE HEMBRA-130 G-CU 1/2*22	3,8000	190
49044	TE HEMBRA-130 G-CU 3/4*18	2,8500	190
49045	TE HEMBRA-130 G-CU 3/4*22	6,3000	190
49046	TE HEMBRA-130 G-CU 1"*28	9,7300	190
49047	TE HEMBRA-130 G-CU 1/2*12	2,4000	190
49048	TE HEMBRA-130 G-CU 3/4* 28	5,6800	190
49049	TE HEMBRA-130 G-CU 1 * 22	4,9800	190
49050	TE HEMBRA-130 G-CU 1 1/2 * 42	32,3300	190
49051	TE HEMBRA-130 G-CU 2*54	30,8600	190
49090	TE HEMBRA-130 G-CU 3/8*12	1,5800	190
49091	TAPON SOLDAR LATON-301-GCu 12 mm	0,3400	190
49092	TAPON SOLDAR LATON-301-GCu 15 mm	0,6200	190
49093	TAPON SOLDAR LATON-301-GCu 18 mm	0,6300	190
49094	TAPON SOLDAR LATON-301-GCu 22 mm	0,8000	190
49122	CRUZ FUNDIDA 180 GCU SOLDAR 22 mm	8,1900	190
49123	CRUZ FUNDIDA 180 GCU SOLDAR 28 mm	12,8900	190
49124	CRUZ FUNDIDA 180 GCU SOLDAR 35 mm	15,2300	190
98051	PUENTE LATON SOLDAR 85 G CU DE 22	8,9800	190
99360	PUENTE LATON SOLDAR 85 G CU DE 15	5,2600	190
99707	PUENTE LATON SOLDAR 85 G CU DE 18	5,9800	190

RACORERÍA DE LATÓN PARA RIEGO

REF.	DESCRIPCIÓN	PVP	PÁG.
69530	ENTRONQUE MANGUE.MACHO 3/8*13	1,6900	192
69531	ENTRONQUE MANGUERA MACHO 1/2*17	1,9300	192
69532	ENTRONQUE MANGUERA MACHO 3/4*22	2,8300	192
69533	ENTRONQUE MANGUERA MACHO 1"*29	3,7200	192
69534	ENTRONQUE MANGUERA MACHO 1"1/4*38	5,8000	192
69535	ENTRONQUE MANGUERA MACHO 1"1/2*43	8,9700	192
69536	ENTRONQUE MANGUERA MACHO 2"*55	13,2000	192
69536A	ENTRONQUE MANGUERA MACHO LARGO 2"*88	15,8700	192
69537	ENTRONQUE MANGUERA MACHO 3"*75	39,6000	192
69554	ENTRONQUE MANGUERA REFOR,MACHO 1 1/4 x 38 mm	5,9000	192
69555	ENTRONQUE MANGUERA REFOR,MACHO 1 1/2 x 43 mm	9,8900	192
69556	ENTRONQUE MANGUERA REFOR.MACHO 2" x 57 mm	14,9300	192
69560	ENTRONQUE MANGUERA MACHO 2"1/2 *61	15,1000	192
69561	ENTRONQUE MANGUERA MACHO 4"*102	63,0000	192
69562	ENTRONQUE MANGUERA REFOR. MACHO 1" x 27 mm	3,9700	192
69563	ENTRONQUE MANGUERA REFOR,MACHO 2" x 50 mm	25,2200	192
99111	MANGUITO EMPALME MANGUERA 3/8 x 13 mm	4,2500	192
99112	MANGUITO EMPALME MANGUERA 1/2 x 16 mm	6,0800	192



99113	MANGUITO EMPALME MANGUERA 3/4 x 21 mm	8,0600	192
99114	MANGUITO EMPALME MANGUERA 1" x 25 mm	13,8000	192
99115	MANGUITO EMPALME MANGUERA 1 1/4 x 31 mm	21,8900	192
99118	TE EMPALME MANGUERA 3/8 x 13 mm	5,0300	192
99119	TE EMPALME MANGUERA 1/2 x 17 mm	7,6000	192
99120	TE EMPALME MANGUERA 3/4 x 21 mm	9,9400	192
99121	TE EMPALME MANGUERA 1" x 25 mm	20,6900	192
99122	LANZA MANGUERA TRES EFECTOS DE 16 mm	12,9500	192
99123	LANZA MANGUERA TRES EFECTOS DE 20 mm	14,9600	192
99124	LANZA MANGUERA TRES EFECTOS DE 25 mm	18,6700	192
48091	COLZADA PARA GRIFO BOCA DE RIEGO RECTA TIPO MADRID	109,9000	193
48092	COLZADA PARA GRIFO BOCA DE RIEGO CURVA TIPO MADRID	99,9800	193
48093	JUNTA CAUCHO COLZADA	1,3600	193
69801	RACOR MANGUERA DOS PIEZAS S/COLOR 3/8	3,2900	193
69802	RACOR MANGUERA DOS PIEZAS S/COLOR 1/2	2,0700	193
69803	RACOR MANGUERA DOS PIEZAS S/COLOR 3/4	3,3500	193
69804	RACOR MANGUERA DOS PIEZAS S/COLOR 1"	4,7200	193
69805	RACOR MANGUERA DOS PIEZAS S/COLOR 1"1/4	13,4400	193
69806	RACOR MANGUERA DOS PIEZAS S/COLOR 1"1/2	16,8000	193
69807	RACOR MANGUERA DOS PIEZAS S/COLOR 2"	14,4600	193
990111	VALVULAS ESFERA RIEGO M1/2 x H3/8	5,3700	193
69601	RACOR BARCELONA MANGUERA-MACHO 20*1/2	4,3800	194
69602	RACOR BARCELONA MANGUERA-MACHO-25*3/4	9,8200	194
69603	RACOR BARCELONA MANGUERA-MACHO-30 * 1"	14,2400	194
69604	RACOR BARCELONA MANGUERA-MACHO-35* 1 1/4	23,3600	194
69605	RACOR BARCELONA MANGUERA-MACHO-45 * 1 1/2	40,0200	194
69606	RACOR BARCELONA MANGUERA-MACHO-60*2"	45,1100	194
69611	RACOR BARCELONA MANGUERA 20*20	5,9800	194
69612	RACOR BARCELONA MANGUERA 25 *25	7,0800	194
69613	RACOR BARCELONA MANGUERA 30 *30	9,5100	194
69614	RACOR BARCELONA MANGUERA 35 *35	24,4600	194
69615	RACOR BARCELONA MANGUERA 40 *40	25,4500	194
69616	RACOR BARCELONA MANGUERA 45*45	41,3800	194
69617	RACOR BARCELONA MANGUERA 50 *50	28,7500	194
69618	RACOR BARCELONA MANGUERA 60 * 60	46,4000	194
69619	RACOR BARCELONA MANGUERA 70 * 70	75,6000	194
69621	RACOR BARCELONA MACHO-MACHO -1/2	5,0700	194
69622	RACOR BARCELONA MACHO-MACHO-3/4	8,7100	194
69623	RACOR BARCELONA MACHO-MACHO-1"	11,8900	194
69624	RACOR BARCELONA MACHO-MACHO-1"1/4	21,9700	194
69625	RACOR BARCELONA MACHO-MACHO-1"1/2	36,1300	194
69626	RACOR BARCELONA MACHO-MACHO-2"	59,7100	194
69631	JUNTA CAUCHO RACOR BARCELONA 20 mm	0,4700	194
69632	JUNTA CAUCHO RACOR BARCELONA 25 mm	0,6500	194
69633	JUNTA CAUCHO RACOR BARCELONA 30 mm	0,4300	194
69634	JUNTA CAUCHO RACOR BARCELONA 35 mm	0,5900	194
69635	JUNTA CAUCHO RACOR BARCELONA 40 mm	0,6600	194
69636	JUNTA CAUCHO RACOR BARCELONA 45 mm	1,0900	194
69637	JUNTA CAUCHO RACOR BARCELONA 50 mm	0,7800	194
69638	JUNTA CAUCHO RACOR BARCELONA 60 mm	1,2800	194
69639	JUNTA CAUCHO RACOR BARCELONA 70 mm	1,2800	194
990100	TE LATON MACHO RIEGO 3/8 x 10 mm	3,0800	195
990101	TE LATON HEMBRA 1/4 x 10 mm	3,9800	195
990102	TE LATON LISA TRES SALIDAS 10 x 10 x10 mm	3,3000	195



990103	BOQUILLA LATON MACHO 1/4 x 10	0,9500	195
990104	BOQUILLA LATON MACHO 3/8 x 10	1,7900	195
990105	BOQUILLA LATON MACHO 1/2 x 10	2,2900	195
990106	BOQUILLA LATON DOBLE LISA DE 8 x 8	1,4500	195
990107	BOQUILLA LATON DOBLE LISA DE 10 x 10	1,4900	195
990108	BOQUILLA LATON RACOR LOCO 1/2 x 8	3,4300	195
990109	BOQUILLA LATON RACOR LOCO 1/2 x 10	1,7500	195
990110	TUERCA ESPECIAL 1/2 -EXA..23 X ALTURA 13 x TALADRO 12.5	0,5600	195

NIPPELS GALVANIZADOS

REF.	DESCRIPCIÓN	PVP	PÁG.
80001	NIPPEL GALVANIZADO ROSCAR M-M 1/2 x 40 mm	1,0600	198
80002	NIPPEL GALVANIZADO ROSCAR M-M 1/2 x 60 mm	1,2800	198
80003	NIPPEL GALVANIZADO ROSCAR M-M 1/2 x 80 mm	1,4800	198
80004	NIPPEL GALVANIZADO ROSCAR M-M 1/2 x 100 mm	1,4800	198
80005	NIPPEL GALVANIZADO ROSCAR M-M 1/2 x 120 mm	1,8100	198
80006	NIPPEL GALVANIZADO ROSCAR M-M 1/2 x 140 mm	1,8100	198
80007	NIPPEL GALVANIZADO ROSCAR M-M 1/2 x 160 mm	2,1400	198
80008	NIPPEL GALVANIZADO ROSCAR M-M 1/2 x 180 mm	2,3900	198
80009	NIPPEL GALVANIZADO ROSCAR M-M 1/2 x 200 mm	2,3900	198
80010	NIPPEL GALVANIZADO ROSCAR M-M 1/2 x 250 mm	3,3800	198
80011	NIPPEL GALVANIZADO ROSCAR M-M 1/2 x 300 mm	3,7100	198
80012	NIPPEL GALVANIZADO ROSCAR M-M 1/2 x 500 mm	5,4800	198
80013	NIPPEL GALVANIZADO ROSCAR M-M 1/2 x 1000 mm	10,8500	198
80016	NIPPEL GALVANIZADO ROSCAR M-M 1/2 x 400 mm	6,2000	198
80017	NIPPEL GALVANIZADO ROSCAR M-M 1/2 x 600 mm	6,7300	198
80020	NIPPEL GALVANIZADO ROSCAR M-M 3/8 x 60 mm	1,5200	198
80101	NIPPEL GALVANIZADO ROSCAR M-M 1/4 x 40 mm	1,4800	198
80102	NIPPEL GALVANIZADO ROSCAR M-M 1/4 x 60 mm	1,1100	198
80103	NIPPEL GALVANIZADO ROSCAR M-M 1/4 x 80 mm	1,2200	198
80104	NIPPEL GALVANIZADO ROSCAR M-M 1/4 x 100 mm	3,5400	198
82021	NIPPEL GALVANIZADO ROSCAR M-M 3/8 x 100 mm	1,6600	198
82022	NIPPEL GALVANIZADO ROSCAR M-M 3/8 x 160 mm	3,9900	198
82024	NIPPEL GALVANIZADO ROSCAR M-M 3/8 x 200 mm	4,1100	198
82029	NIPPEL GALVANIZADO ROSCAR M-M 3/8 x 300 mm	3,9600	198
98025	NIPPEL GALVANIZADO ROSCAR M-M 3/8*120 mm	1,7600	198
98026	NIPPEL GALVANIZADO ROSCAR M-M 3/8*500 mm	7,4100	198
98031	NIPPEL GALVANIZADO ROSCAR M-M 3/8 x 80 mm	1,6200	198
99030	NIPPEL GALVANIZADO ROSCAR M-M 3/8*40 mm	1,1200	198
80501	NIPPEL GALVANIZADO ROSCAR M-M 3/4 x 40 mm	1,4600	199
80502	NIPPEL GALVANIZADO ROSCAR M-M 3/4 x 60 mm	1,4800	199
80503	NIPPEL GALVANIZADO ROSCAR M-M 3/4 x 80 mm	1,9200	199
80504	NIPPEL GALVANIZADO ROSCAR M-M 3/4 x 100 mm	2,1400	199
80505	NIPPEL GALVANIZADO ROSCAR M-M 3/4 x 120 mm	2,4800	199
80506	NIPPEL GALVANIZADO ROSCAR M-M 3/4 x 140 mm	2,5800	199
80507	NIPPEL GALVANIZADO ROSCAR M-M 3/4 x 160 mm	2,8200	199
80508	NIPPEL GALVANIZADO ROSCAR M-M 3/4 x 180 mm	2,6400	199
80509	NIPPEL GALVANIZADO ROSCAR M-M 3/4 x 200 mm	3,7600	199
80510	NIPPEL GALVANIZADO ROSCAR M-M 3/4 x 250 mm	4,8800	199
80511	NIPPEL GALVANIZADO ROSCAR M-M 3/4 x 300 mm	5,7600	199
80515	NIPPEL GALVANIZADO ROSCAR M-M 3/4 x 400 mm	5,8700	199
80516	NIPPEL GALVANIZADO ROSCAR M-M 3/4 x 500 mm	12,7700	199
81001	NIPPEL GALVANIZADO ROSCAR M-M 1" x 40 mm	1,5800	199
81002	NIPPEL GALVANIZADO ROSCAR M-M 1" x 60 mm	1,9800	199



81003	NIPPEL GALVANIZADO ROSCAR M-M 1" x 80 mm	2,3100	199
81004	NIPPEL GALVANIZADO ROSCAR M-M 1" x 100 mm	2,8700	199
81005	NIPPEL GALVANIZADO ROSCAR M-M 1" x 120 mm	2,9700	199
81006	NIPPEL GALVANIZADO ROSCAR M-M 1" x 140 mm	3,1300	199
81007	NIPPEL GALVANIZADO ROSCAR M-M 1" x 160 mm	4,0300	199
81008	NIPPEL GALVANIZADO ROSCAR M-M 1" x 180 mm	3,8700	199
81009	NIPPEL GALVANIZADO ROSCAR M-M 1" x 200 mm	5,6000	199
81010	NIPPEL GALVANIZADO ROSCAR M-M 1" x 250 mm	6,3000	199
81011	NIPPEL GALVANIZADO ROSCAR M-M 1" x 300 mm	8,6900	199
81013	NIPPEL GALVANIZADO ROSCAR M-M 1" x 500 mm	12,6900	199
81014	NIPPEL GALVANIZADO ROSCAR M-M 1" x 400 mm	8,9500	199
81501	NIPPEL GALVANIZADO ROSCAR M-M 1"1/4 x 60 mm	2,5600	199
81502	NIPPEL GALVANIZADO ROSCAR M-M 1"1/4 x 80 mm	2,7200	199
81503	NIPPEL GALVANIZADO ROSCAR M-M 1"1/4 x 100 mm	2,1400	199
81504	NIPPEL GALVANIZADO ROSCAR M-M 1"1/4 x 120 mm	4,9600	199
81505	NIPPEL GALVANIZADO ROSCAR M-M 1"1/4*140 mm	3,8800	199
81506	NIPPEL GALVANIZADO ROSCAR M-M 1"1/4 x 160 mm	7,9200	199
81507	NIPPEL GALVANIZADO ROSCAR M-M 1"1/4 x 180 mm	4,9900	199
81508	NIPPEL GALVANIZADO ROSCAR M-M 1"1/4 x 200 mm	6,3700	199
81509	NIPPEL GALVANIZADO ROSCAR MM 1"1/4*250 mm	6,6800	199
81510	NIPPEL GALVANIZADO ROSCAR M-M 1"1/4*300 mm	9,3300	199
81512	NIPPEL GALVANIZADO ROSCAR.M-M 1 1/4*500 mm	14,6700	199
81514	NIPPEL GALVANIZADO ROSCAR M-M 1 1/4 X 400 mm	11,9600	199
82001	NIPPEL GALVANIZADO ROSCAR M-M 1"1/2 x 60 mm	2,7200	200
82002	NIPPEL GALVANIZADO ROSCAR M-M 1"1/2 x 80 mm	3,2100	200
82003	NIPPEL GALVANIZADO ROSCAR M-M 1"1/2 x 100 mm	4,6400	200
82004	NIPPEL GALVANIZADO ROSCAR M-M 1"1/2 x 120 mm	4,2900	200
82005	NIPPEL GALVANIZADO ROSCAR M-M 1"1/2 x 140 mm	4,9900	200
82006	NIPPEL GALVANIZADO ROSCAR M-M 1"1/2 x 160 mm	6,6400	200
82007	NIPPEL GALVANIZADO ROSCAR M-M 1"1/2 x 180 mm	6,3500	200
82008	NIPPEL GALVANIZADO ROSCAR M-M 1"1/2 x 200 mm	8,9200	200
82009	NIPPEL GALVANIZADO ROSCAR M-M 1"1/2 x 250 mm	11,4700	200
82010	NIPPEL GALVANIZADO ROSCAR M-M 1"1/2 x 300 mm	9,6500	200
82012	NIPPEL GALVANIZADO ROSCAR M-M 1"1/2 x 500 mm	18,9000	200
82013	NIPPEL GALVANIZADO ROSCAR M-M 1"1/2 x 400 mm	11,9500	200
82501	NIPPEL GALVANIZADO ROSCAR M-M 2" x 60 mm	3,8600	200
82502	NIPPEL GALVANIZADO ROSCAR M-M 2" x 80 mm	3,0600	200
82503	NIPPEL GALVANIZADO ROSCAR M-M 2" x 100 mm	4,9000	200
82504	NIPPEL GALVANIZADO ROSCAR M-M 2" x 120 mm	5,6100	200
82505	NIPPEL GALVANIZADO ROSCAR M-M 2" x 140 mm	5,6100	200
82506	NIPPEL GALVANIZADO ROSCAR M-M 2" x 160 mm	12,6800	200
82507	NIPPEL GALVANIZADO ROSCAR M-M 2" x 180 mm	7,5900	200
82508	NIPPEL GALVANIZADO ROSCAR M-M 2" x 200 mm	11,7600	200
82509	NIPPEL GALVANIZADO ROSCAR M-M 2" x 250 mm	9,9700	200
82510	NIPPEL GALVANIZADO ROSCAR M-M 2" x 300 mm	11,5700	200
82511	NIPPEL GALVANIZADO ROSCAR M-M 2" x 500 mm	20,6000	200
82513	NIPPEL GALVANIZADO ROSCAR M-M 2" x 400 mm	26,1000	200
82520	NIPPEL GALVANIZADO ROSCAR M-M 2"1/2 x 100 mm	10,5900	200
82521	NIPPEL GALVANIZADO ROSCAR M-M 2"1/2 x 120 mm	7,5800	200
82522	NIPPEL GALVANIZADO ROSCAR M-M 2 1/2 x 160 mm	13,9200	200
82523	NIPPEL GALVANIZADO ROSCAR M-M 2"1/2 x 200 mm	19,2000	200
82524	NIPPEL GALVANIZADO ROSCAR M-M 2 1/2 x 300 mm	17,2000	200
82525	NIPPEL GALVANIZADO ROSCAR M-M 2"1/2 x 500 mm	25,8900	200
82530	NIPPEL GALVANIZADO ROSCAR M-M 3" x 100 mm	12,9200	200



82531	NIPPEL GALVANIZADO ROSCAR M-M 3"*120 mm	16,7400	200
82532	NIPPEL GALVANIZADO.ROSCAR M-M 3"*160 mm	13,1100	200
82533	NIPPEL GALVANIZADO ROSCAR M-M 3" x 200 mm	15,8400	200
82534	NIPPEL GALVANIZADO ROSCAR M-M 3"*300 mm	26,2500	200
82535	NIPPEL GALVANIZADO ROSCAR M-M 3"*500 mm	52,2200	200

VÁLVULAS DE FUNDICIÓN

REF.	DESCRIPCIÓN	PVP	PÁG.
82901	RACOR UNION FUNDICION MALEABLE M-1/2 x 21,3 mm	14,6900	202
82902	RACOR UNION FUNDICION MALEABLE M-3/4 x 26,9 mm	18,9300	202
82903	RACOR UNION FUNDICION MALEABLE M-1" x 33,7 mm	19,9000	202
82904	RACOR UNION FUNDICION MALEABLE M-1"1/4 x 42,4 mm	21,5800	202
82905	RACOR UNION FUNDICION MALEABLE M-1"1/2 x 48,3 mm	28,2600	202
82906	RACOR UNION FUNDICION MALEABLE M-2" x 60,3 mm	49,9900	202
82907	RACOR UNION FUNDICION MALEABLE M-21/2 x 76,1mm	91,8700	202
82915	RACOR UNION FUNDICION MALEABLE H-1/2 x 21,3 mm	15,8400	202
82916	RACOR UNION FUNDICION MALEABLE H-3/4 x 26,9 mm	17,3600	202
82917	RACOR UNION FUNDICION MALEABLE H-1" x 33,7 mm	19,9700	202
82918	RACOR UNION FUNDICION MALEABLE H-1"1/4 x 42,4 mm	29,9800	202
82919	RACOR UNION FUNDICION MALEABLE H-1"1/2 x 48,3 mm	36,3000	202
82920	RACOR UNION FUNDICION MALEABLE H-2" x 60,3 mm	54,7200	202
82925	RACOR UNION FUNDICION MALEABLE TUBO-TUBO 3/8 x 17,2 mm	18,8300	202
82926	RACOR UNION FUNDICION MALEABLE TUBO-TUBO 1/2 x 21,3 mm	20,9400	202
82927	RACOR UNION FUNDICION MALEABLE TUBO-TUBO 3/4 x 26,9 mm	24,1100	202
82928	RACOR UNION FUNDICION MALEABLE TUBO-TUBO 1" x 33,7 mm	22,1100	202
82929	RACOR UNION FUNDICION MALEABLE TUBO-TUBO 1"1/4 x 42,4 mm	29,4500	202
82930	RACOR UNION FUNDICION MALEABLE TUBO-TUBO 1"1/2 x 48,3 mm	38,4700	202
82931	RACOR UNION FUNDICION MALEABLE TUBO-TUBO 2" x 60,3 mm	59,9000	202
82971	ABRAZADERA DE REPARACION FUNDICION MALEABLE 1/2 x 70 mm corto	9,2800	203
82972	ABRAZADERA DE REPARACION FUNDICION MALEABLE 3/4 x 70 mm corto	9,9500	203
82973	ABRAZADERA DE REPARACION FUNDICION MALEABLE 1" x 70 mm corto	13,2800	203
82974	ABRAZADERA DE REPARACION FUNDICION MALEABLE 1"1/4 x 80 mm corto	16,8000	203
82975	ABRAZADERA DE REPARACION FUNDICION MALEABLE 1"1/2 x 100 mm corto	20,3800	203
82976	ABRAZADERA DE REPARACION FUNDICION MALEABLE 2" x 100 mm corto	26,9100	203
82978	ABRAZADERA DE REPARACION FUNDICION MALEABLE 3" x 76,1 mm	68,8500	203
82981	ABRAZADERA DE REPARACION FUNDICION MALEABLE 1/2 x 140 mm largo	20,0500	203
82982	ABRAZADERA DE REPARACION FUNDICION MALEABLE 3/4 x 140 mm largo	22,1200	203
82983	ABRAZADERA DE REPARACION FUNDICION MALEABLE 1" x 140 mm largo	27,7000	203
83124	ABRAZADERA DE REPARACION TAPAPOROS COBRE 15 mm	14,8400	203
83126	ABRAZADERA DE REPARACION TAPAPOROS COBRE 18 mm	16,2800	203
83127	ABRAZADERA DE REPARACION TAPAPOROS COBRE 22 mm	18,6500	203
83128	ABRAZADERA DE REPARACION TAPAPOROS COBRE 28 mm	24,2500	203
83141	ABRAZADERA CON TOMA TIPO RB 1/2 x 18	21,4900	203
83142	ABRAZADERA CON TOMA TIPO RB 1/2 x 22	23,2600	203
83143	ABRAZADERA CON TOMA TIPO RB 3/4 x 28	29,9300	203
82562	MANGUITO ANTIVIBRATORIO DOBLE ONDA 3/4	22,8700	204
82563	MANGUITO ANTIVIBRATORIO DOBLE ONDA 1"	24,1200	204
82564	MANGUITO ANTIVIBRATORIO DOBLE ONDA 1 1/4	36,4300	204
82565	MANGUITO ANTIVIBRATORIO DOBLE ONDA 1 1/2	44,6500	204
82566	MANGUITO ANTIVIBRATORIO DOBLE ONDA 2"	53,7800	204
82567	MANGUITO ANTIVIBRATORIO DOBLE ONDA 2"1/2	77,3500	204
82568	MANGUITO ANTIVIBRATORIO DOBLE ONDA 3"	98,9600	204
82801	CONEXION MANGUERA GALVANIZADA 3/8 x 100	1,6400	204
82802	CONEXION MANGUERA GALVANIZADA 1/2 x 100	1,8900	204



82803	CONEXION MANGUERA GALVANIZADA 3/4 x 100	2,7000	204
82804	CONEXION MANGUERA GALVANIZADA 1" x 100	4,2100	204
82805	CONEXION MANGUERA GALVANIZADA 1"1/4 x 100	4,2700	204
82806	CONEXION MANGUERA GALVANIZADA 1"1/2 x 100	6,3800	204
82807	CONEXION MANGUERA GALVANIZADA 2" x 100	7,2000	204
82808	CONEXION MANGUERA GALVANIZADA 2"1/2 x 120	12,7500	204
82809	CONEXION MANGUERA GALVANIZADA 3" x 100	18,6300	204

CALEFACCIÓN			
REF.	DESCRIPCIÓN	PVP	PÁG.
90040	PURGADOR AUTOMATICO DE AIRE S/COLOR-3/8	9,3900	206
90041	PURGADOR AUTOMATICO DE AIRE 1/2	9,8300	206
90045	PURGADOR AUTOMATICO DE AIRE APERTURA LATERAL S/COLOR-3/8	8,6400	206
90046	PURGADOR AUTOMATICO DE AIRE APERTURA LATERAL S/COLOR-1/2	8,4100	206
90049	PURGADOR AUTOMATICO DE AIRE TOMA LATERAL S/COLOR-3/8	7,8100	206
90050	PURGADOR AUTOMATICO DE AIRE TOMA LATERAL 1/2	7,9600	206
90053	VALVULA RETENCION PURGADOR AUTOMATICO S/COLOR-3/8	1,3000	206
90054	VALVULA RETENCION PURGADOR AUTOMATICO S/COLOR-1/2	1,6000	206
90057	PURGADOR AIRE RADIADOR CROMO 1/8	1,3300	207
90058	PURGADOR AIRE RADIADOR CROMO 1/4	0,8800	207
90059	PURGADOR AIRE RADIADOR CROMO 3/8	1,3700	207
90060	PURGADOR AIRE RADIADOR CROMO 1/2	2,9000	207
90065	DISPOSITIVO ANTIGOTEIO VALVULA DE SEGURIDAD 1/2	5,9600	207
90070	PURGADOR AUTOMATICO RADIADOR CROMO ROSCA IZQUIERDA-1"	10,6000	207
90071	PURGADOR AUT.RADIADOR CROMO ROSCA IZQUIERDA 1"1/4	8,6900	207
90072	PURGADOR AUTOMATICO RADIADOR CROMO ROSCA DERECHA-1"	8,6900	207
90073	PURGADOR AUT.RADIADOR CROMO ROSCA DERECHA 1 1/4	8,6900	207
90074	VALVULA SEGURIDAD SIN SISTEMA DE RETENCION	3,7300	207
90075	VAL.SEGURIDAD Y RETENCION SIN PALANCA 3/8--PRESION 8 BAR	3,1000	207
90076	VAL.SEGURIDAD Y RETENCION CON PALANCA 1/2 -PRESION 8 BAR	4,8500	207
90077	VAL.SEGURIDAD Y RETENCION SIN PALANCA 3/4-PRESION 8 BAR	7,9600	207
90078	VAL.SEGURIDAD Y RETENCION CON PALANCA 3/4- PRESION 8 BAR	11,2000	207
90079	VAL. SEGURIDAD Y RETENCION CON PALANCA 1/2 - PRESION 10 BAR	5,7500	207
90098	VALVULA DE SEGURIDAD Y RETENCION PARA TERMO 3/4-10 BAR	11,2000	207
99506	VALVULA SEGURIDAD Y RETENCION SIN PALANCA-1/2	3,7500	207
90080	VAL.ESCUADRA*3/8*M-M- REGULACION MANUAL	10,8600	208
90081	VAL.ESCUADRA *1/2*M-M-REGULACION MANUAL	9,5500	208
90082	VAL.ESCUADRA*3/8*M-M- REGULACION MANUAL CON JUNTAS	11,4500	208
90083	VAL.ESCUADRA *1/2-M-M-REGULACION MANUAL CON JUNTAS	13,0000	208
90084	DETENTOR-A-ESC.*3/8*M-M-REGULACION MANUAL	9,7500	208
90085	DETENTOR-A-ESC. *1/2*M-M-REGULACION MANUAL	7,5200	208
90086	DETENTOR -A ESC.* 3/8 *M-M-REGULACION MANUAL CON JUNTAS	11,0500	208
90087	DETENTOR-A-ESC. *1/2*M-M-REGULACION MANUAL CON JUNTAS	10,9500	208
90088	VAL.ESCUADRA*3/8*M-H- REGULACION MANUAL	11,7900	209
90089	VAL.ESCUADRA *1/2*M-H-REGULACION MANUAL	8,2300	209
90090	VAL.ESCUADRA*3/8*M-H- REGULACION MANUAL CON JUNTAS	9,7800	209
90093	VAL.ESCUADRA *1/2*M-H-REGULACION MANUAL CON JUNTAS	14,1500	209
90094	DETENTOR-A-ESC.*3/8*M-H-REGULACION MANUAL	5,6900	209
90095	DETENTOR-A-ESC.*1/2*M-H-REGULACION MANUAL	11,0500	209
90096	DETENTOR-A-ESC.*3/8*M-H-REGULACION MANUAL CON JUNTAS	7,2300	209
90097	DETENTOR-A-ESC. *1/2*M-H-REGULACION MANUAL CON JUNTAS	11,9300	209
90100	VAL.ESCUADRA*3/8*M-M- TERMOSTATIZABLE	9,2500	210
90101	VAL.ESCUADRA*1/2*M-M- TERMOSTATIZABLE	10,8800	210
90102	VAL.ESCUADRA*3/8*M-M-TERMOSTATIZABLE CON JUNTAS	9,6600	210



90103	VAL.ESCUADRA*1/2*M-M-TERMOSTATIZABLE CON JUNTAS	13,2400	210
90108	VAL.ESCUADRA *3/8*M-H-TERMOSTATIZABLE	9,5700	210
90109	VAL.ESCUADRA *1/2*M-H-TERMOSTATIZABLE	10,6200	210
90110	VAL.ESCUADRA*3/8*M-H-TERMOSTATIZABLE CON JUNTAS	9,9800	210
90111	VAL.ESCUADRA*1/2*M-H- TERMOSTATIZABLE CON JUNTAS	11,2000	210
90001	COLECTOR 2 CONEX.24 x 19 (36) 3/4-M-H CON VALVULA-ISTANT-	21,9300	211
90002	COLECTOR 2 CONEX.24 x 19 (36) 1"-M-H- CON VALVULA-ISTANT-	20,6000	211
90003	COLECTOR 3 CONEX.24 x 19 (36) 3/4-M-H- CON VALVULA-ISTANT	30,9900	211
90004	COLECTOR 3 CONEX.24 x 19 (36) 1"-M-H- CON VALVULA-ISTANT-	29,9800	211
90005	COLECTOR 4 CONEX.24 x 19 (36) 3/4-M-H- CON VALVULA-ISTANT-	56,2800	211
90006	COLECTOR 4 CONEX.24 x 19 (36) 1"- M-H-CON VALVULA-ISTANT-	38,9000	211
90011	COLECTOR 2 CONEX.24 x 19 (36) 3/4"-M-H-THERMODAY	10,7500	211
90012	COLECTOR 2 CONEX.24 x 19 (36) 1"-M-H-THERMODAY	16,9000	211
90013	COLECTOR 3 CONEX.24 x 19 (36) 3/4"-M-H-THERMODAY	17,8600	211
90014	COLECTOR 3 CONEX.24 x 19 (36) 1"-M-H-THERMODAY	22,8200	211
90015	COLECTOR 4 CONEX.24 x 19 (36) 3/4"-M-H-THERMODAY	18,2600	211
90016	COLECTOR 4 CONEX.24 x 19 (36) 1"M-H.THERMODAY	28,8900	211
90226	COLECTOR 2 VIAS H 1"-H1/2 S/COLOR DE 114 mm	12,0600	211
90228	COLECTOR 4 VIAS H 1"-H1/2 S/COLOR DE 214mm	23,2500	211
90229	COLECTOR 5 VIAS H 1"-H1/2 S/COLOR DE 264mm	59,6300	211
90230	COLECTOR 6 VIAS H 1"-H1/2 S/COLOR DE 314mm	34,4700	211
90232	COLECTOR 8 VIAS H 1"-H1/2 S/COLOR DE 414mm	45,6300	211
90234	COLECTOR 10 VIAS H 1"-H1/2 S/COLOR DE 514mm	118,1000	211
90237	COLECTOR 4 VIAS H 1"1/4-H1/2 S/COLOR DE 220mm	30,0900	211
90239	COLECTOR 6 VIAS H 1"1/4-H1/2 S/COLOR DE 320mm	51,5200	211
90242	COLECTOR 9 VIAS H 1"1/4-H1/2 S/COLOR DE 470mm	64,0200	211
90243	COLECTOR 10 VIAS H 1"1/4-H1/2 S/COLOR DE 520mm	69,7500	211
90245	COLECTOR 12 VIAS H 1"1/4-H1/2 S/COLOR DE 620mm	129,7100	211
90252	COLECTOR 4 VIAS H-1"1/2 -H 1" S/COLOR entre ejes 100 mm	239,7900	211
90253	COLECTOR 6 VIAS H-1"1/2 -H 1" S/COLOR entre ejes 100 mm	344,9300	211
90031	CAJA COLECTOR 310 x 310 x 90 (2-3)- PLASTIBOX-	27,9500	212
90032	CAJA COLECTOR 460 x 310 x 90 (4-7)- PLASTIBOX-	27,2200	212
90033	CAJA COLECTOR 610 x 310 x 90 (8-12)- PLASTIBOX-	33,3400	212
90034	SOPORTE PARA CAJAS DE PLASTICO COLECTORES DE 3/4-CONTROLLER-	1,6900	212
90035	SOPORTE PARA CAJAS DE PLASTICO COLECTORES DE 1"-CONTROLLER-	1,6900	212
90036	PERFIL PARA CAJA DE PLASTICO 400mm-PLASTIBOX	15,5500	212
90037	SOPORTE PARA CAJAS DE PLASTICO COLECTORES DE 3/4-THERMODAY-	1,2900	212
90038	SOPORTE PARA CAJAS DE PLASTICO COLECTORES DE 1"-THERMODAY-	1,2900	212
90120	CABEZAL TERMOSTATICO CON SENSOR LIQUIDO	15,0800	213
90128	VALVULA MONOTUBO TERMOSTATIZABLE 1/2 x 18 con sonda 450 mm	45,9300	213
90135	CRONOTERMOSTATO ELECTRONICO SEMANAL FRONTAL TRASPARENTE	54,4000	213
90136	CRONOTERMOSTATO ELECTRONICO SEMANAL FRONTAL NEGRO	44,8000	213
90137	TERMOSTATO AMBIENTE MECANICO	19,5000	213
90140	TUERCA MONOBLOC PARA TUBO COBRE NIQUELADA Ø 12	2,8100	214
90141	TUERCA MONOBLOC PARA TUBO COBRE NIQUELADA Ø 14	1,8500	214
90142	TUERCA MONOBLOC PARA TUBO COBRE NIQUELADA Ø 15	2,6900	214
90143	TUERCA MONOBLOC PARA TUBO COBRE NIQUELADA Ø 16	2,4400	214
90146	TUERCA MONOBLOC CON BICONO PARA TUBO COBRE NIQUELADA Ø 18	2,2700	214
90150	TUERCA MONOBLOC PARA TUBO MULTICAPA PREMONTADA NIQUELADA Ø 16 x 2	3,9900	214
90151	TUERCA MONOBLOC PARA TUBO MULTICAPA PREMONTADA NIQUELADA Ø 16 x 2,25	3,5400	214
90152	TUERCA MONOBLOC PARA TUBO MULTICAPA PREMONTADA NIQUELADA Ø 20 x 2	3,3100	214
90153	TUERCA MONOBLOC PARA TUBO MULTICAPA PREMONTADA NIQUELADA Ø 20 x 2,5	3,1000	214
90154	TUERCA MONOBLOC PARA TUBO MULTICAPA PREMONTADA NIQUELADA Ø 25 x 2,5	5,5400	214
90161	TUERCA MONOBLOC PARA PEX-POLIPRO.-POLIB.NIQUEL PREMONTADA Ø 16 x 2	4,7600	214



90162	TUERCA MONOBLOC PARA PEX-POLIPRO.-POLIB.NIQUEL PREMONTADA Ø 18 x 2	3,2000	214
90163	TUERCA MONOBLOC PARA PEX-POLIPRO.-POLIB.NIQUEL PREMONTADA Ø 20 x 2	3,2000	214
90170	CONJUNTO TUERCA Y RACOR SERI POKER 1/2	3,5700	214
90171	CONJUNTO TUERCA Y RACOR COLECTOR CON JUNTA TORICA	4,3900	214
90258	TAPON RADIADOR BLANCO 1" x 1/4 DERECHA	0,9900	215
90259	TAPON RADIADOR BLANCO 1" x 1/4 IZQUIERDA	0,9900	215
90260	FLORON UNIVERSAL BLANCO CALEFACCION 8-22 mm	0,3300	215
90261	FLORON UNIVERSAL CROMADO CALEFACCION 12-18 mm	1,0800	215
90266	LLAVE NYLON PARA TAPONES	7,3500	215
90268	TAPON RADIADOR ZINCADO 1" DERECHA	1,0800	215
90269	TAPON RADIADOR ZINCADO 1" IZQUIERDA	1,0800	215
90270	TAPON RADIADOR ZINCADO 1" x 1/8 DERECHA	0,6500	215
90271	TAPON RADIADOR ZINCADO 1" x 1/8 IZQUIERDA	1,0800	215
90272	TAPON RADIADOR ZINCADO 1" x 1/4 DERECHA	0,5900	215
90273	TAPON RADIADOR ZINCADO 1" x 1/4 IZQUIERDA	0,5900	215
90274	TAPON RADIADOR ZINCADO 1" x 3/8 DERECHA	0,5900	215
90275	TAPON RADIADOR ZINCADO 1" x 3/8 IZQUIERDA	0,5900	215
90276	TAPON RADIADOR ZINCADO 1" x 1/2 DERECHA	1,0800	215
90277	TAPON RADIADOR ZINCADO 1" x 1/2 IZQUIERDA	1,0800	215
90278	TAPON RADIADOR BLANCO 1" DERECHA	1,0800	215
90279	TAPON RADIADOR BLANCO 1" IZQUIERDA	0,9900	215
90280	TAPON RADIADOR BLANCO 1" x 1/8 DERECHA	0,9900	215
90281	TAPON RADIADOR BLANCO 1" x 1/8 IZQUIERDA	0,9900	215
90282	TAPON RADIADOR BLANCO 1" x 3/8 DERECHA	0,9900	215
90283	TAPON RADIADOR BLANCO 1" x 3/8 IZQUIERDA	0,9900	215
90284	TAPON RADIADOR BLANCO 1" x 1/2 DERECHA	0,9900	215
90285	TAPON RADIADOR BLANCO 1" x 1/2 IZQUIERDA	1,1200	215
90290	KIT UNIVERSAL TAPONES ZINCADOS 1"	7,6900	215
90291	KIT UNIVERSAL TAPONES BLANCOS 1"	8,8500	215
90296	CASQUILLO RADIADOR 1"	0,4400	216
90301	SOPORTE RADIADOR REGULABLE METAL 1"	1,5600	216
90302	SOPORTE RADIADOR METAL 1 PATILLA	0,4700	216
90306	SOPORTE RADIADOR NYLON 1 PATILLA	1,0500	216

JUNTAS Y ARANDELAS			
REF.	DESCRIPCIÓN	PVP	PÁG.
83001	JUNTA TORICA AN 1*2,90 x 1,78	0,0250	218
83002	JUNTAS TORICAS AN2 *3,68 x 1,78	0,0250	218
83003	JUNTAS TORICAS AN3 *4,47 x 1,78	0,0250	218
83004	JUNTAS TORICAS AN4 *5,28 x 1,78	0,0250	218
83005	JUNTAS TORICAS AN5 *6,07 x 1,78	0,0250	218
83006	JUNTAS TORICAS AN6 *7,65 x 1,78	0,0250	218
83007	JUNTAS TORICAS AN7 *9,25 x 1,78	0,0250	218
83008	JUNTAS TORICAS AN8 *9,19 x 2,62	0,0310	218
83009	JUNTAS TORICAS AN9 *10,77 x 2,62	0,0310	218
83010	JUNTAS TORICAS AN10 *12,37 x 2,62	0,0340	218
83011	JUNTAS TORICAS AN11 *13,94 x 2,62	0,0410	218
83012	JUNTAS TORICAS AN12 *15,54 x 2,62	0,0410	218
83013	JUNTAS TORICAS AN13 *17,12 x 2,62	0,0410	218
83014	JUNTAS TORICAS AN14 *18,72 x 2,62	0,0520	218
83015	JUNTAS TORICAS AN15 *18,64 x 3,53	0,0680	218
83016	JUNTAS TORICAS AN16 *20,22 x 3,53	0,0800	218
83017	JUNTAS TORICAS AN17 *21,82 x 3,53	0,0950	218
83018	JUNTAS TORICAS AN18 *23,39 x 3,53	0,0950	218



83019	ESTUCHE JUNTAS TORICAS NBR-70 EN PULGADAS	29,6000	218
83020	JUNTA TORICA AN*00* 2.20 x 1.6*	0,0280	218
83065	ESTUCHE JUNTAS TORICAS NBR-70 METRICA	41,1700	218
99520	MALETIN PARA JUNTAS	10,7500	218
83502	JUNTA CAUCHO PLANA ANCHA 3/8 *14,5 x 8 x 2	0,0300	219
83503	JUNTA CAUCHO PLANA ANCHA 1/2 *18,5 x 10 x 2	0,0300	219
83504	JUNTA CAUCHO PLANA ANCHA 3/4 *23,5 x 13 x 2	0,0420	219
83505	JUNTA CAUCHO PLANA ANCHA 1" *30 x 20 x 2,5	0,0700	219
83506	JUNTA CAUCHO PLANA ANCHA 1"1/4 *37,5 x 28,5 x 2.5	0,1100	219
83507	JUNTA CAUCHO PLANA ANCHA 1"1/2 *44,5 x 30 x 2,5	0,1300	219
83508	JUNTA CAUCHO PLANA ANCHA 2" *56 x 46 x 2,5	0,1600	219
83509	JUNTA CAUCHO PLANA ANCHA 3/4 * 23,5 x 13 x 3	0,0460	219
83515	JUNTA CON FILTRO INOX DE 1/2	0,4900	219
83516	JUNTA CON FILTRO INOX DE 3/4	0,5400	219
83520	JUNTA CAUCHO PLANA ANCHA 1/2*18,5 x 10 x 4	0,0580	219
84002	JUNTA CAUCHO PLANA NORMAL 3/8 *14,5 x 10 x 2	0,0350	219
84003	JUNTA CAUCHO PLANA NORMAL 1/2 *18,5 x 14 x 2	0,0430	219
84004	JUNTA CAUCHO PLANA NORMAL 3/4 *23,5 x 18 x 2	0,0450	219
84005	JUNTA CAUCHO PLANA NORMAL 1" *30 x 24 x 2,5	0,0570	219
84006	JUNTA CAUCHO PLANA NORMAL 1"1/4 *35 x 29,5 x 2,5	0,0880	219
84007	JUNTA CAUCHO PLANA NORMAL 1"1/2 *44,5 x 37 x 2,5	0,0990	219
84008	JUNTA CAUCHO PLANA NORMAL 2" * 56 x 50 x 2,5	0,1600	219
84009	ESTUCHE JUNTAS PLANAS CAUCHO *ART.835*	28,0700	219
84010	ESTUCHE JUNTAS PLANAS DE CAUCHO*ARTI.840-835*	39,7000	219
84011	ESTUCHE JUNTAS PLANAS CAUCHO *ART.840*	28,0700	219
99322	JUNTA CAUCHO PLANA NORMAL 2 1/2 -57 * 69,5 *3,5	0,3000	219
99334	JUNTA CAUCHO PLANA NORMAL 3" -70 * 82,5 * 3,5	0,4300	219
84012	ARANDELA GOMA CONICA 3/8 *13 x 50 mm	0,3700	220
84013	ARANDELA GOMA CONICA 1/2 *18 x 51 mm	0,4400	220
84014	ARANDELA GOMA CONICA 3/4 *25 x 57 mm	0,5100	220
84015	ARANDELA GOMA CONICA 1" * 30 x 61 mm	0,5300	220
84016	ARANDELA GOMA CONICA 1"1/4 * 35 x 61 mm	0,5400	220
84017	ARANDELA GOMA CONICA 1"1/2 * 44 x 66 mm	0,9900	220
84018	ARANDELA GOMA CONICA 2" *54 x 83 mm	0,8000	220
84022	ARANDELA GOMA SEMI-CONICA 3/8 * 14 x 50 mm	0,7800	220
84023	ARANDELA GOMA SEMI-CONICA 1/2 *18 x 51 mm	0,4600	220
84024	ARANDELA GOMA SEMI-CONICA 3/4 * 25 x 57 mm	0,5100	220
84025	ARANDELA GOMA SEMI-CONICA 1" * 30 x 61 mm	0,5200	220
84026	ARANDELA GOMA SEMI-CONICA 1"1/4 * 35 x 61 mm	0,5400	220
84027	ARANDELA GOMA SEMI-CONICA 1"1/2 * 44 x 66 mm	0,7700	220
84028	ARANDELA GOMA SEMI-CONICA 2" *54 x 83 mm	0,9800	220
84032	ARANDELA GOMA PLANA BLANCA 3/8 * 16 x 32 mm	0,0750	220
84033	ARANDELA GOMA PLANA BLANCA 1/2 * 20 x 45 mm	0,1200	220
84034	ARANDELA GOMA PLANA BLANCA 3/4 *25 x 60 mm	0,1700	220
84035	ARANDELA GOMA PLANA BLANCA 1" * 35 x 70 mm	0,2100	220
84036	ARANDELA GOMA PLANA BLANCA 1"1/4 *40 x 70 mm	0,2500	220
84037	ARANDELA GOMA PLANA BLANCA 1"1/2 * 45 x 70 mm	0,2500	220
84038	ARANDELA GOMA PLANA BLANCA 2" *54 x 80 mm	0,2500	220
84501	JUNTA PLANA DE FIBRA 16*1'5	0,1000	220
84502	JUNTA PLANA DE FIBRA 17*1'5	0,1000	220
84503	JUNTA PLANA DE FIBRA 18*1'5	0,1000	220
84504	JUNTA PLANA DE FIBRA 19*1'5	0,1000	220
84505	JUNTA PLANA DE FIBRA 20*1'5	0,1000	220
84506	JUNTA PLANA DE FIBRA 21*1'5	0,1000	220

84507	JUNTA PLANA DE FIBRA 22*1'5	0,1000	220
84508	ESTUCHE JUNTAS PLANAS FIBRA	69,7000	220
84514	JUNTA KLINGER*RACOR *1 1/4 *38 x 32 x 1,5	0,1800	221
84515	JUNTA KLINGER 1/8 RACORD * 9 x 5 x 1,5	0,0700	221
84516	JUNTA KLINGER 1/4 * 11 x 6 x 1,5	0,0780	221
84517	JUNTA KLINGER 3/8 RACOR * 14 ,5 x 9 x 1,5	0,0700	221
84518	JUNTA KLINGER 1/2*10 FLEXO * 19x 10 x 1,5	0,1300	221
84519	JUNTA KLINGER 1/2*12 RACORD * 18 x 12 x 1,5	0,1600	221
84520	JUNTA KLINGER 1/2 RACOR * 18 x 14 x 1,5	0,1600	221
84521	JUNTA KLINGER 3/4 BATERIA * 24 x 13 x 1,5	0,1900	221
84522	JUNTA KLINGER 3/4 RACORD * 24 x 17 x 1,5	0,1900	221
84523	JUNTA KLINGER 3/4 RACORD * 24 x 18 x 1,5	0,1900	221
84524	JUNTA KLINGER 1" RACOR * 30 x 24 x 1,5	0,1900	221
84525	JUNTA KLINGER 1" ANCHA * 30 x 20 x 1,5	0,1900	221
84526	JUNTA KLINGER 1"1/4*ANCHA * 38 x 29 x 1,5	0,2000	221
84527	JUNTA KLINGER 1"1/2*ANCHA * 45 x 30 x 1,5	0,2000	221
84528	JUNTA KLINGER 1" RADIADOR * 42 x 33 x 1,5	0,1900	221
84529	ESTUCHE JUNTAS PLANAS KLINGER S/AMIANTO	77,0500	221
84532	JUNTA KLINGER 2" RACOR 54 x 47 x 2 mm	0,3400	221
84533	JUNTA PLANA TEFLON 7/8 * 27 x 21 x 1.5	0,1900	221
84535	JUNTA PLANA TEFLON ANCHA 3/8 * 14.5 x 7 x 1.5	0,1000	221
84536	JUNTA PLANA TEFLON 3/8 RACOR *14,5 x 10 x 1,5	0,0900	221
84537	JUNTA PLANA TEFLON 1/2 FLEXO * 18.5 x 11 x 1.5	0,1400	221
84538	JUNTA PLANA TEFLON 1/2x12 RACORD * 18.5 x 12 x 1.5	0,1400	221
84539	JUNTA PLANA TEFLON 1/2 ESTRECHA * 18.5 x 14 x 1.5	0,1300	221
84540	JUNTA PLANA TEFLON 3/4*13 BATERIA * 24 x 13 x 1.5	0,2300	221
84541	JUNTA PLANA TEFLON 3/4 * 18 BATERIA *24 x 18 x 1.5	0,1500	221
84542	JUNTA PLANA TEFLON 3/4 ESTRECHA * 24 x 19 x 1.5	0,1500	221
84543	JUNTA PLANA TEFLON 1" RACORD * 30 x 24 x1.5	0,2000	221
84544	JUNTA PLANA TEFLON 1"1/4 * 39 x 30 x 1.5	0,2900	221
84545	JUNTA PLANA TEFLON 1"1/2 * 45 x 37 x 1.5	0,2400	221
84546	JUNTA PLANA TEFLON RADIADOR 1" * 42 x 33 x 1.5	0,1900	221
84547	JUNTA PLANA TEFLON RADIADOR 1"1/4 * 50 x 41 x1.5	0,2300	221
84548	ESTUCHE JUNTAS PLANAS TEFLON	103,8700	221
84549	JUNTA PLANA TEFLON 1" ANCHA * 30 x 20 x 1.5	0,2900	221
84550	JUNTA PLANA TEFLON RACOR LOCO 2" -57 x 46 x 1,5	0,4700	221
84555	JUNTA KLINGER 2" *ANCHA 54 x 44 x 2 mm	0,4900	221

MEMBRANAS			
REF.	DESCRIPCIÓN	PVP	PÁG.
88041	MEMBRANA CALENTADOR 5 LITROS ANTIGUO Nº2	0,9600	224
88042	MEMBRANA CALENTADOR 10 LITROS MODERNO Nº3	1,3200	224
88043	MEMBRANA CALENTADOR 10 LITROS ANTIGUO Nº19	0,9600	224
88044	MEMBRANA CALENTADOR 5 LITROS COINTRA Nº0	1,3200	224
88045	MEMBRANA CALENTADOR 5 LITROS 205 DAVID Nº4	0,9600	224
88046	MEMBRANA CALENTADOR 5 LITROS 5-K MODERNO Nº5	0,9600	224
88047	MEMBRANA CALENTADOR 10 LITROS TE ANTIGUO Nº6	0,9600	224
88048	MEMBRANA CALENTADOR 10 LITROS TE 10 K MODERNO Nº 7	0,9600	224
88049	MEMBRANA CALENTADOR 10 LITROS BULES ANTIGUO Nº 8	0,9600	224
88050	MEMBRANA CALENTADOR 5 LITROS D-15-D50 MODERNO Nº33	1,3200	224
88051	MEMBRANA CALENTADOR 5-10 LITROS ANTIGUO BAJA PRESION Nº 9	0,7500	224
88052	MEMBRANA CALENTADOR 5-10 LITROS MODERNO Nº 10	0,7500	224
88053	MEMBRANA CALENTADOR 5-10 LITROS MODERNO Nº 11	0,9600	224
88054	MEMBRANA CALENTADOR 5-10 LITROS MODERNO Nº 12	0,9600	224



88055	MEMBRANA CALENTADOR ALTA Y BAJA PRESION Nº 37	0,9600	224
88056	MEMBRANA CALENTADOR ALTA Y BAJA PRESION Nº 38	0,9600	224
88057	MEMBRANA CALENTADOR 5 LITROS MODERNO MODELO FD 330 Nº 13	1,4500	224
88059	MEMBRANA CALENTADOR 5 LITROS ANTIGUO Nº 25	0,9600	224
88060	MEMBRANA CALENTADOR 10 LITROS ANTIGUO Nº 26	0,9600	224
88061	MEMBRANA CALENTADOR 5 LITROS MODERNO C51-C52 Nº 15	0,9600	224
88062	MEMBRANA CALENTADOR 5 LITROS ANTIGUO LM 8 BAJA PRESION Nº30	1,0500	224
88063	MEMBRANA CALENTADOR 10 LITROS MODERNO LM25-LM26 Nº 36	1,0500	224
88064	MEMBRANA CALENTADOR 5 LITROS MODERNO LM8 PRESION NORMAL Nº 16	1,0500	224
88065	MEMBRANA CALENTADOR 10 LITROS LM25-LM26 PRESION NORMAL Nº28	1,0500	224
88066	MEMBRANA CALENTADOR 10 LITROS MODERNO Nº 17	0,9600	224
88067	MEMBRANA CALENTADOR 5 LITROS ANTIGUO Nº18	0,9600	224
88068	MEMBRANA CALENTADOR 5 LITROS MODERNO Nº 22	0,9600	224
88069	MEMBRANA CALENTADOR 10 LITROS MODERNO Nº 20	0,9600	224
88070	MEMBRANA CALENTADOR 5 LITROS MODERNO Nº 21	0,9600	224
88071	MEMBRANA CALENTADOR 10 LITROS MODERNO Nº 23	0,9600	224
88072	MEMBRANA CALENTADOR 5-10 LITROS MODERNO Nº 27	0,9600	224
88073	MEMBRANA CALENTADOR ROCA CHAFOTEAUX Nº 34	0,9600	224
88074	MEMBRANA CALENTADOR CHAFOTEAUX Nº 35	0,9600	224
88075	MEMBRANA CALENTADOR TROPIK Nº 24	1,0500	224

SOLETAS Y PORTASOLETAS

REF.	DESCRIPCIÓN	PVP	PÁG.
87001	PORTA SOLETAS ACERO INOX.16/150 12 * 13	0,1200	226
87002	PORTA SOLETAS ACERO INOX.17/150	0,1200	226
87003	PORTA SOLETAS ACERO INOX.18/150	0,1200	226
87004	PORTA SOLETAS ACERO INOX.19/150--15 X 16--	0,1200	226
88001	SOLETA RECAMBIO 12*4*4	0,0370	226
88002	SOLETA RECAMBIO 13*4*4	0,0370	226
88003	SOLETA RECAMBIO 14*4*4	0,0370	226
88004	SOLETA RECAMBIO 15*4*4	0,0370	226
88005	SOLETA RECAMBIO 16*4*4	0,0380	226
88006	SOLETA RECAMBIO 17*4*4	0,0380	226
88007	SOLETA RECAMBIO 18*4*4	0,0400	226
88008	SOLETA RECAMBIO 20*4*4	0,0540	226
88009	ESTUCHE SOLETAS CAUCHO	36,7900	226
88010	SOLETA RECAMBIO CIEGA 12*4	0,0370	226
88011	SOLETA RECAMBIO CIEGA 13*4	0,0370	226
88012	SOLETA RECAMBIO CIEGA 14*4	0,0370	226
88013	SOLETA RECAMBIO CIEGA 15*4	0,0370	226
88014	SOLETA RECAMBIO CIEGA 16*4	0,0380	226
88015	SOLETA RECAMBIO CIEGA 17*4	0,0380	226
88016	SOLETA RECAMBIO CIEGA 18*4	0,0460	226
88017	SOLETA RECAMBIO CIEGA 20*4	0,0530	226
88018	JUNTA SOLETA MONTURA 1"-27 x 5 x 4	0,2000	226
88026	SOLETA RECAMBIO 24*4*4	0,1500	226
99166	PORTA SOLETA LATON 3/4 V.POLI- 22 x 4 x 20	0,4900	226

ACCESORIOS DE SELLADO

REF.	DESCRIPCIÓN	PVP	PÁG.
73001	ROLLO CINTA TEFLON 12 * 12 x 0,75	0,3300	228
73003	ROLLO CINTA TEFLON GAS 12 *12 x 0,1	0,3900	228
73004	ROLLO CINTA TEFLON 19 * 50 x 0,1	2,9000	228
73005	BOTE HILO TEFLON DE 160 MTS.	25,6300	228



73006	BOTE HILO TEFLON DE 50 MTS.	16,9500	228
73007	MADEJA CAÑAMO CANAL FINO 200 GRAMOS	4,2800	228
73008	PASTA TIPO UNIBOND PARA ROSCAR CON CAÑAMO 400 gr	9,9600	228
99069	TEFLON LIQUIDO P.T.P.E. SEAL 50 ML	22,7500	228
99070	TEFLON LIQUIDO P.T.P.E. SEAL 100 ML	23,7500	228
49095	CARRETE ESTAÑO COBRE APTO PARA SOLDAR GAS 250 gr al 6%	32,8000	229
49096	CARRETE ESTAÑO PLATA TIPO MAR-PLUS 250gms. al 3'5%	15,6000	229
49097	CARRETE ESTAÑO PLATA TIPO MAR-PLUS 250gms.al 6%	16,9900	229
49098	GEL DECAPANTE FLUX 100 gms	3,6000	229
73009	BOLSA LANA ACERO DE 63 GRAMOS**10 ROLLITOS**	3,2500	229
73015	CINTA ADHESIVA PLATA DE 50 mts x 50 mm	9,0700	229
73016	CINTA ADHESIVA PLATA DE 10 mts x 50 mm	2,9800	229
73017	CINTA AMERICANA REFORZADA DE 25 mts x 50mm	7,9600	229

ACCESORIOS PARA GAS			
REF.	DESCRIPCIÓN	PVP	PÁG.
73030	REGULADOR BOTELLA BUTANO DOMESTICO	15,4800	232
73031	REGULADOR PRESION SALIDA REGULADA HASTA 1,7 bar-mando negro	29,9800	232
73032	REGULADOR BOTELLA BUTANO CON CORTE	23,7600	232
73033	RACORD ACOPLAMIENTO REGULADOR	4,1500	232
73036	MANGUERA PARA GAS BUTANO BICAPA 9 x 15 mm - ROLLO 60 m	96,0000	232
73037	MANGUERA PARA GAS BUTANO 1,50 metros con abrazaderas	4,8300	232
89004	BOQUILLA PLANA ACOPLAR TUERCA 1/2 - 20/150- 21,8 IZQUIERDA	1,9600	232
89002	UNION HERMETO GAS CROMO 10 x 10 mm	4,3700	233
89003	UNION HERMETO GAS CROMO 12 x 12 mm	4,9300	233
89006	UNION REDUCIDA HERMETO GAS CROMO 10 x 12 mm	4,9200	233
89007	REDUCCION HERMETO GAS CROMO 1/2 x 10 mm	3,7200	233
89008	REDUCCION HERMETO GAS CROMO 1/2 x 12 mm	4,0900	233
89009	REDUCCION HERMETO GAS CROMO 3/4 x 10 mm	4,8200	233
89010	REDUCCION HERMETO GAS CROMO 3/4 x 12 mm	5,1500	233
89012	BOQUILLA HERMETO GAS CROMO 10 mm	3,1500	233
89013	BOQUILLA HERMETO GAS CROMO 12 mm	3,5200	233
89017	CODO HERMETO GAS CROMO 10 mm	5,7100	233
89018	CODO HERMETO GAS CROMO 12 mm	6,0400	233
89021	TE HERMETO GAS CROMO 10 mm	7,7100	233
89022	TE HERMETO GAS CROMO 12 mm	6,5300	233
89015	BOQUILLA LISA GAS S/COLOR DE 10 mm	1,1500	234
89016	BOQUILLA LISA GAS S/COLOR DE 12 mm	1,1800	234
89046	UNION LATON SOLDAR 10 x 10 mm	1,0900	234
89047	UNION LATON SOLDAR 12 x 12 mm	0,8900	234
89048	UNION LATON SOLDAR 10 x 12 mm	0,9400	234
89050	BOQUILLA LATON SOLDAR GAS 10 mm	1,1800	234
89051	BOQUILLA LATON SOLDAR GAS 12 mm	1,2100	234
89052	BOQUILLA LATON SOLDAR 10 mm*CANARIAS*	0,2300	234
89071	CODO LATON SOLDAR GAS 10 mm	2,6200	234
89072	TE LATON SOLDAR GAS 10 mm	3,5900	234
89073	CODO LATON SOLDAR GAS 12 mm	3,0600	234
89074	TE LATON SOLDAR GAS 12 mm	3,9300	234
89024	TUERCA HERMETO GAS CROMO 10 mm	0,9300	235
89025	TUERCA HERMETO GAS CROMO 12 mm	1,1300	235
89026	TUERCA VALVULA GAS SOLDAR CROMO 10 mm	0,7000	235
89027	BICONO LATON RECOCIDO HERMETO GAS 10 mm	0,3700	235
89028	BICONO LATON HERMETO GAS 12 mm	0,5200	235
89033	TUERCA CONEXION GAS CROMO 20/150 x 15,3 mm	1,4600	235



89034	TUERCA CONEXION GAS CROMO 21'8 IZQUIERDA x 15,3 mm	1,4600	235
89035	TUERCA CONEXION GAS CROMO 1/2 x 15 mm	1,4800	235
89036	TUERCA CONEXION GAS CROMO 1/2 x 17 mm	1,1600	235
89038	MANGUITO LATON GAS 20/150 x 10 mm	0,8600	235
89039	MANGUITO LATON GAS 20/150 x 12 mm	0,8700	235
89040	MANGUITO LATON GAS 1/2 x 14 mm	0,7200	235
89041	MANGUITO LATON GAS 1/2 x 15 mm	0,7500	235
89042	JUNTA GOMA PLANA GAS MANGUITO SOLDAR 20/150 - 17 x 12 x 2	0,1000	235
89043	JUNTA GOMA PLANA VALVULA GAS SOLDAR 10---14 x 10 x 2	0,1000	235
89044	MANGUITO LATON VALVULA GAS SOLDAR 10 mm	0,6200	235
99361	CONJ.TUERCA Y BICONO COMP.3/8x10	2,9200	235
99364	CONJ.TUERCA Y BICONO COMP.1/2 x 10	4,0500	235
89053	VALVULA GAS SOLDAR 10 x 10 mm	17,1700	236
89054	VALVULA GAS SOLDAR 12 x 12 mm	19,1400	236
89056	VALVULA GAS HERMETO 10 x 10 mm	14,9800	236
89057	VALVULA GAS HERMETO 12 x 12 mm	13,0600	236
89062	VALVULA ROSCAR GAS 20/150 x 20/150	9,8300	236
89063	VALVULA ROSCAR GAS 20/150 x 21'8 IZQUIERDA	9,9900	236
89064	VALVULA ROSCAR GAS 1/2 x 1/2	14,5600	236
89066	ABRAZADERA PUENTE PARA TUBO 10 mm	0,7300	236
89067	ABRAZADERA PUENTE PARA TUBO 12 mm	0,8800	236
89068	ABRAZADERA TUBO DE GOMA 14 x 16	0,3900	236
89069	DERIVACION BOQUILLA S/COLOR 3 SALIDAS	3,9500	236
89070	DERIVACION BOQUILLA-HERMETO CROMO 10 mm	4,9800	236
89066A	VALVULA ROSCAR GAS 3/4 x 3/4	15,2000	236
89069A	ABRAZADERA TUBO DE GOMA 16 x 18	0,4900	236
89095	SOPORTE CONTADOR DE GAS FRONTAL	2,9500	237
89096	SOPORTE CONTADOR GAS LATERAL	3,1400	237
890101	TAPA PARA CONTADOR DE GAS FRONTAL	4,2500	237
890102	TAPA PARA CONTADOR DE GAS LATERAL	3,9900	237
890103	TAPA ESPECIAL PARA CONTADOR DE GAS	2,9700	237
890104	TAPA SEPARADORA PARA CONTADOR DE GAS	4,5400	237

ACCESORIOS DE VENTILACIÓN

REF.	DESCRIPCIÓN	PVP	PÁG.
60001	REJILLA EMPOTRAR ACERO COLOR BLANCO 17 x 17	2,9800	240
60002	REJILLA EMPOTRAR ALUMINIO S/ COLOR 17 x 17	2,3500	240
60003	REJILLA EMPOTRAR ALUMINIO COLOR MADERA 17 x 17	2,8200	240
60004	REJILLA EMPOTRAR ALUMINIO COLOR BLANCO 17 x 17	3,2200	240
60005	REJILLA EMPOTRAR ACERO COLOR BLANCO 20 x 20	3,1000	240
60006	REJILLA EMPOTRAR ALUMINIO S/ COLOR 20 x 20	2,6000	240
60007	REJILLA EMPOTRAR ALUMINIO COLOR BLANCO 20 x 20	3,4300	240
60011	REJILLA PLANA ACERO COLOR BLANCO 10*10	0,8900	240
60012	REJILLA PLANA ALUMINIO S/COLOR 10*10	0,8000	240
60013	REJILLA PLANA ALUMINIO COLOR BLANCO 10*10	1,4400	240
60014	REJILLA PLANA ALUMINIO COLOR MADERA 10*10	0,9900	240
60016	REJILLA PLANA ACERO COLOR BLANCO 10*20---horizontal	1,6000	240
60017	REJILLA PLANA ALUMINIO S/COLOR 10*20-*horizontal	1,3000	240
60018	REJILLA PLANA ALUMINIO COLOR BLANCO 10*20-horizontal	1,3500	240
60019	REJILLA PLANA ALUMINIO COLOR MADERA 10*20-horizontal	1,3500	240
60501	REJILLA PLANA ACERO COLOR BLANCO 15*15	1,5000	240
60502	REJILLA PLANA ALUMINIO S/COLOR 15*15	1,4000	240
60503	REJILLA PLANA ALUMINIO COLOR MADERA 15*15	1,4000	240
60504	REJILLA PLANA ALUMINIO COLOR BLANCO 15*15	1,6000	240



60505	REJILLA PLANA ALUMINIO COLOR BLANCO 15x30	2,8500	240
60506	REJILLA PLANA ACERO COLOR BLANCO 17*17	1,7000	240
60507	REJILLA PLANA ALUMINIO S/COLOR 17*17	1,5200	240
60508	REJILLA PLANA ALUMINIO COLOR MADERA 17*17	2,2100	240
60509	REJILLA PLANA ALUMINIO COLOR BLANCO 17*17	1,8300	240
60511	REJILLA PLANA ACERO COLOR BLANCO 20*20	1,9300	240
60512	REJILLA PLANA ALUMINIO S/COLOR 20*20	1,8200	240
60513	REJILLA PLANA ALUMINIO COLOR BLANCO 20*20	2,4800	240
60514	REJILLA PLANA ALUMINIO COLOR MADERA 20 x 20	2,4800	240
60515	REJILLA ACERO PLANA COLOR BLANCO 15*30	2,8000	240
60516	REJILLA PLANA ALUMINIO S/COLOR 15*30	2,2400	240
60517	REJILLA PLANA ALUMINIO COLOR MADERA 15*30	2,3700	240
60518	REJILLA CUADRADA ABS BLANCA SIN CIERRE 17*17	1,8100	241
60519	REJILLA CUADRADA ABS COLOR MADERA SIN CIERRE 17*17	1,4300	241
60520	REJILLA RECTANGULAR ABS BLANCA SIN CIERRE 22 x 9,5	1,9500	241
60521	REJILLA RECTANGULAR ABS MADERA SIN CIERRE 22 x 9,5	1,6800	241
60522	MARCO REJILLA ABS BLANCO 17*17	0,8900	241
60524	MARCO REJILLA ABS BLANCO 22 x 9,5	0,9600	241
60525	MARCO REJILLA ABS COLOR MADERA 22 x 9,5	0,6600	241
60526	REJILLA ABS BLANCA REDONDA 150 mm	2,2000	241
60527	REJILLA ABS COLOR MADERA REDONDA 150 mm	1,6700	241
60528	REJILLA PLANA ABS BLANCA SIN CIERRE 15*15	1,7500	241
60529	MARCO REJILLA ABS BLANCO 15*15	0,8400	241
60530	MARCO REJILLA REDONDA ABS BLANCO 150 mm	1,1500	241
60533	REJILLA CUADRADA CON CIERRE BLANCA 17*17	2,6800	241
60534	REJILLA CUADRADA ABS BLANCA CON CIERRE 20*20	3,5600	241
60536	REJILLA RECTANGULAR ABS BLANCA CON CIERRE 22 x 9,50	2,3900	241
60532	MOSQUITERA REJILLA ABS 22 x 9,5 cm	0,7100	242
60537	REJILLA Y MARCO ABS BLANCO SIN CIERRE 17*17	2,6700	242
60539	REJILLA Y MARCO ABS BLANCO 20 x 20	3,3500	242
60540	REJILLA Y MARCO ABS BLANCO 22 x 9,5	2,5500	242
60541	REJILLA Y MARCO REDONDA ABS BLANCO 15 x 15	2,8200	242
61001	DIFUSOR BLANCO 2 DISCOS 0 100	4,5600	242
61002	DIFUSOR BLANCO 2 DISCOS 0 110	4,5600	242
61003	DIFUSOR BLANCO 2 DISCOS 0 120	4,5600	242
61004	DIFUSOR BLANCO 2 DISCOS 0 125	4,9000	242
61005	DIFUSOR BLANCO 2 DISCOS 0 130	4,9000	242
61101	DIFUSOR BLANCO 3 DISCOS 0 100	3,9800	242
61102	DIFUSOR BLANCO 3 DISCOS 0 110	4,6500	242
61103	DIFUSOR BLANCO 3 DISCOS 0 120	4,9900	242
61104	DIFUSOR BLANCO 3 DISCOS 0 125	5,1500	242
61105	DIFUSOR BLANCO 3 DISCOS 0 130	5,5500	242
61120	DIFUSOR TRES DISCOS ALUMINIO BLANCO 100	11,3600	242
61121	DIFUSOR TRES DISCOS ALUMINIO BLANCO 110	13,4000	242
61122	DIFUSOR TRES DISCOS ALUMINIO BLANCO 120	11,3360	242
61123	DIFUSOR TRES DISCOS ALUMINIO BLANCO 125	11,3600	242
61124	DIFUSOR TRES DISCOS ALUMINIO BLANCO 130	11,3600	242

SUMIDEROS, CALDERETAS Y BOTE SIFÓNICO

REF.	DESCRIPCIÓN	PVP	PÁG.
25522	SUMIDERO LATON 10*10 ROSCA 1 1/4" CROMO	19,7200	244
25534	SUMIDERO SIFONICO PVC 10*10 SALIDA 50* VERTICAL-HORIZONTAL	7,1800	244
25535	SUMIDERO SIFONICO PVC 15*15 SALIDA 75-50	8,9600	244
25536	SUMIDERO SIFONICO PVC 20*20 SALIDA 110-90	8,9600	244



25537	SUMIDERO SIFONICO PVC 25*25 SALIDA 110-90	10,5300	244
25538	CALDERETA SIFONICA PVC 15*15 SALIDA 75	8,9200	244
25539	CALDERETA SIFONICA PVC 20*20 SALIDA 110-90	15,2600	244
25540	CALDERETA SIFONICA PVC 25*25 SALIDA VERTICAL 110-90	16,0800	244
25541	BOTE SIFONICO CIERRE HERMETICO 110 mm	6,6200	244
25542	CALDERETA SIFONICA PVC 10*10 SALIDA 50 C/ REJILLA PLASTICO	6,5000	244

ACCESORIOS DE COBRE			
REF.	DESCRIPCIÓN	PVP	PÁG.
49201	RACOR SOLDAR 2P 359 GCU 3/8 * 10 CON ALOJA. JUNTA	1,3600	246
49202	RACOR SOLDAR 2P 359 GCU 3/8 * 12 CON ALOJA. JUNTA	1,4200	246
49204	RACOR SOLDAR 2P 359 GCU 3/8 * 15 CON ALOJA. JUNTA	1,2300	246
49206	RACOR SOLDAR 2P 359 GCU 1/2 * 12 CON ALOJA. JUNTA	1,4900	246
49207	RACOR SOLDAR 2P 359 GCU 1/2 * 14 CON ALOJA. JUNTA	1,1100	246
49208	RACOR SOLDAR 2P 359 GCU 1/2*15 CON ALOJA. JUNTA	1,2900	246
49209	RACOR SOLDAR 2P 359 GCU 1/2*16 CON ALOJA. JUNTA	1,2600	246
49210	RACOR SOLDAR 2P 359 GCU 1/2*18 CON ALOJA. JUNTA	1,7400	246
49211	RACOR SOLDAR 2P 359 GCU 1/2*22 CON ALOJA. JUNTA	3,2000	246
49212	RACOR SOLDAR 2P 359 GCU 3/4*14 CON ALOJA. JUNTA	1,8000	246
49213	RACOR SOLDAR 2P 359 GCU 3/4*15 CON ALOJA. JUNTA	2,1600	246
49214	RACOR SOLDAR 2P 359 GCU 3/4*16 CON ALOJA. JUNTA	1,9600	246
49215	RACOR SOLDAR 2P 359 GCU 3/4*18 CON ALOJA. JUNTA	2,0500	246
49216	RACOR SOLDAR 2P 359 GCU 3/4*22 CON ALOJA. JUNTA	2,2900	246
49217	RACOR SOLDAR 2P 359 GCU 1"x 22 CON ALOJA. JUNTA	3,3500	246
49218	RACOR SOLDAR 2P 359 GCU 1"x 28 CON ALOJA. JUNTA	4,5200	246
49219	RACOR SOLDAR 2P 359 GCU 3/4 x 28 CON ALOJA. JUNTA	4,7400	246
49221	RACOR SOLDAR 2P 359 GCU 1 1/4 x 28 CON ALOJA. JUNTA	6,5400	246
49222	RACOR SOLDAR 2P 359 GCU 1 1/4 x 35 CON ALOJA. JUNTA	7,4300	246
49224	RACOR SOLDAR 2P 359 GCU 1 1/2 x 42 CON ALOJA. JUNTA	9,7400	246
49226	RACOR SOLDAR 2P 359 GCU 2" x 54 CON ALOJA. JUNTA	17,7400	246
49234	RACOR SOLDAR 2P 359 GCU 1/2 x 12 JUNTA PLANA	1,4900	246
49236	RACOR SOLDAR 2P 359 GCU 1/2 x 15 JUNTA PLANA	1,3400	246
49238	RACOR SOLDAR 2P 359 GCU 1/2 x 18 JUNTA PLANA	1,7300	246
49239	RACOR SOLDAR 2P 359 GCU 3/4 x 22 JUNTA PLANA	2,7100	246
49241	RACOR SOLDAR 2P 359 GCU 3/4 x 15 JUNTA PLANA	2,1600	246
49242	RACOR SOLDAR 2P 359 GCU 3/4 x 16 JUNTA PLANA	1,9600	246
49243	RACOR SOLDAR 2P 359 GCU 3/4 x 18 JUNTA PLANA	2,0500	246
49244	RACOR SOLDAR 2P 359 GCU 1/2 x 22 JUNTA PLANA	3,3800	246
49245	RACOR SOLDAR 2P 359 GCU 3/4 x 28 JUNTA PLANA	4,9700	246
49246	RACOR SOLDAR 2P 359 GCU 1" x 22 JUNTA PLANA	4,3600	246
49247	RACOR SOLDAR 2P 359 GCU 1" x 28 JUNTA PLANA	4,1900	246
49248	RACOR SOLDAR 2P 359 GCU 1"1/4 x 28 JUNTA PLANA	5,2500	246
49249	RACOR SOLDAR 2P 359 GCU 1"1/4 x 35 JUNTA PLANA	7,1200	246
49250	RACOR SOLDAR 2P 359 GCU 1"1/2 x 42 JUNTA PLANA	10,1600	246
49252	RACOR SOLDAR 2P 359 GCU 2" x 54 JUNTA PLANA	18,9300	246
49262	RACOR SOLDAR 2P 359 GCU 1/2 x 12 CON ALOJA. JUNTA- PRECINTO	1,7100	247
49263	RACOR SOLDAR 2P 359 GCU 1/2 x 14 CON ALOJA. JUNTA- PRECINTO	1,3000	247
49264	RACOR SOLDAR 2P 359 GCU 1/2 x 15 CON ALOJA. JUNTA- PRECINTO	1,8200	247
49265	RACOR SOLDAR 2P 359 GCU 1/2 x 16 CON ALOJA. JUNTA- PRECINTO	1,3300	247
49267	RACOR SOLDAR 2P 359 GCU 1/2 x 18 CON ALOJA. JUNTA- PRECINTO	1,9900	247
49268	RACOR SOLDAR 2P 359 GCU 1/2 x 22 CON ALOJA. JUNTA- PRECINTO	3,5600	247
49270	RACOR SOLDAR 2P 359 GCU 3/4 x 15 CON ALOJA. JUNTA- PRECINTO	2,4700	247
49271	RACOR SOLDAR 2P 359 GCU 3/4 x 18 CON ALOJA. JUNTA- PRECINTO	2,3400	247
49272	RACOR SOLDAR 2P 359 GCU 3/4 x 22 CON ALOJA. JUNTA- PRECINTO	2,9000	247



49273	RACOR SOLDAR 2P 359 GCU 3/4 x 28 CON ALOJA.JUNTA- PRECINTO	5,1200	247
49276	RACOR SOLDAR 2P 359 GCU 1" x 28 CON ALOJA.JUNTA- PRECINTO	3,3200	247
49277	RACOR SOLDAR 2P 359 GCU 1 1/4 x 28 CON ALOJA.JUNTA- PRECINTO	5,2500	247
49278	RACOR SOLDAR 2P 359 GCU 1 1/4 x 35 CON ALOJA.JUNTA- PRECINTO	7,8700	247
49280	RACOR SOLDAR 2P 359 GCU 1 1/2 x 42 CON ALOJA.JUNTA- PRECINTO	10,8000	247
49281	RACOR SOLDAR 2P 359 GCU 7/8 x 22 CON ALOJA.JUNTAS -PRECINTO	2,7700	247
49282	RACOR SOLDAR 2P 359 GCU 2 1/2 x 64 CON ALOJ.JUNTA-PRECINTO	36,3800	247
49283	RACOR SOLDAR 2P 359 GCU 2"*42 CON ALOJA.JUNTAS-PRECINTO	14,9600	247
49284	RACOR SOLDAR 2P 359 GCU 15*20/150 CON ALOJ.JUNTAS-PRECINTO	2,0000	247
49285	RACOR SOLDAR 2P 359 18*20/150 COON ALOJ.JUNTAS-PRECINTO	2,0200	247
49286	RACOR SOLDAR 2P 359 GCU 1*18 CON ALOJA.JUNTA-PRECINTO	3,1800	247
49301	RACOR SOLDAR 2P 359 GCU 3/8 x 12 JUNTA PLANA CON PRECINTO	1,5900	247
49302	RACOR SOLDAR 2P 359 GCU 1/2 x 12 JUNTA PLANA CON PRECINTO	2,4500	247
49304	RACOR SOLDAR 2P 359 GCU 1/2 x 15 JUNTA PLANA CON PRECINTO	1,6100	247
49305	RACOR SOLDAR 2P 359 GCU 1/2 x 16 JUNTA PLANA CON PRECINTO	1,8500	247
49306	RACOR SOLDAR 2P 359 GCU 1/2 x 18 JUNTA PLANA CON PRECINTO	1,9900	247
49307	RACOR SOLDAR 2P 359 GCU 1/2 x 22 JUNTA PLANA CON PRECINTO	5,1700	247
49309	RACOR SOLDAR 2P 359 GCU 3/4 x 15 JUNTA PLANA CON PRECINTO	2,6500	247
49312	RACOR SOLDAR 2P 359 GCU 3/4 x 18 JUNTA PLANA CON PRECINTO	2,6400	247
49314	RACOR SOLDAR 2P 359 GCU 3/4 x 22 JUNTA PLANA CON PRECINTO	2,5600	247
49315	RACOR SOLDAR 2P 359 GCU 3/4 x 28 JUNTA PLANA CON PRECINTO	12,9600	247
49316	RACOR SOLDAR 2P 359 GCU 1" x 28 JUNTA PLANA CON PRECINTO	5,7100	247
49317	RACOR SOLDAR 2P 359 GCU 1"1/4 x 28 JUNTA PLANA CON PRECINTO	5,8400	247
49318	RACOR SOLDAR 2P 359 GCU 1"1/4 x 35 JUNTA PLANA CON PRECINTO	9,8900	247
49319	RACOR SOLDAR 2P 359 GCU 1"1/2 x 42 JUNTA PLANA CON PRECINTO	10,3800	247
49326	RACOR SOLDAR 2P CURVO 2AGCu 3/8 x 12 CON ALOJ.JUNTA	1,7400	248
49329	RACOR SOLDAR 2P CURVO 2AGCu 1/2 x 12 CON ALOJ.JUNTA	2,0900	248
49330	RACOR SOLDAR 2P CURVO 2AGCu 1/2 x 14 CON ALOJ.JUNTA	1,6800	248
49331	RACOR SOLDAR 2P CURVO 2AGCu 1/2 x 15 CON ALOJ.JUNTA	2,0700	248
49332	RACOR SOLDAR 2P CURVO 2AGCu 1/2 x 16 CON ALOJ.JUNTA	1,7600	248
49333	RACOR SOLDAR 2P CURVO 2AGCu 1/2 x 18 CON ALOJ.JUNTA	2,3400	248
49334	RACOR SOLDAR 2P CURVO 2AGCu 3/4 x 15 CON ALOJ.JUNTA	3,2500	248
49336	RACOR SOLDAR 2P CURVO 2AGCu 3/4 x 18 CON ALOJ.JUNTA	2,6200	248
49337	RACOR SOLDAR 2P CURVO 2AGCu 3/4 x 22 CON ALOJ.JUNTA	3,8300	248
49338	RACOR SOLDAR 2P CURVO 2AGCu 1" x 22 CON ALOJ.JUNTA	4,2300	248
49350	RACOR SOLDAR 2P CURVO 2AGCu 1/2 x 12 CON PRECINTO	2,4900	248
49352	RACOR SOLDAR 2P CURVO 2AGCu 1/2 x 15 CON PRECINTO	1,8600	248
49354	RACOR SOLDAR 2P CURVO 2AGCu 1/2 x 18 CON PRECINTO	3,1400	248
49355	RACOR SOLDAR 2P CURVO 2AGCu 3/4 x 15 CON PRECINTO	2,8600	248
49356	RACOR SOLDAR 2P CURVO 2AGCu 3/4 x 18 CON PRECINTO	3,8400	248
49357	RACOR SOLDAR 2P CURVO 2AGCu 3/4 x 22 CON PRECINTO	2,9900	248
49367	RACOR SOLDAR 2P CURVO 2AGCu 1/2 x 12 JUNTA PLANA	2,4400	248
49368	RACOR SOLDAR 2P CURVO 2AGCu 1/2 x 15 JUNTA PLANA	2,0500	248
49370	RACOR SOLDAR 2P CURVO 2AGCu 1/2 x 18 JUNTA PLANA	2,3400	248
49371	RACOR SOLDAR 2P CURVO 2AGCu 3/4 x 15 JUNTA PLANA	3,2500	248
49372	RACOR SOLDAR 2P CURVO 2AGCu 3/4 x 16 JUNTA PLANA	2,7000	248
49373	RACOR SOLDAR 2P CURVO 2AGCu 3/4 x 18 JUNTA PLANA	3,4200	248
49374	RACOR SOLDAR 2P CURVO 2AGCu 3/4 x 22 JUNTA PLANA	3,5600	248
49375	RACOR SOLDAR 2P CURVO 2AGCu 1" x 22 JUNTA PLANA	4,2800	248
49376	RACOR SOLDAR 2P CURVO 2AGCu 1" x 28 JUNTA PLANA	7,6700	248
49381	RACOR SOLDAR 2P CURVO 2AGCu 1/2 x 12 JUNTA PLANA CON PRECINTO	2,2500	248
49382	RACOR SOLDAR 2P CURVO 2AGCu 1/2 x 15 JUNTA PLANA CON PRECINTO	2,2500	248
49383	RACOR SOLDAR 2P CURVO 2AGCu 1/2 x 18 JUNTA PLANA CON PRECINTO	2,5900	248
49384	RACOR SOLDAR 2P CURVO 2AGCu 3/4 x 15 JUNTA PLANA CON PRECINTO	3,3300	248



49385	RACOR SOLDAR 2P CURVO 2AGCU 3/4 x 16 JUNTA PLANA CON PRECINTO	3,3900	248
49386	RACOR SOLDAR 2P CURVO 2AGCU 3/4 x 18 JUNTA PLANA CON PRECINTO	3,2500	248
49387	RACOR SOLDAR 2P CURVO 2AGCU 3/4 x 22 JUNTA PLANA CON PRECINTO	3,3800	248
49388	RACOR SOLDAR CURVO 2P 2AGCU 1" x 22 JUNTA PLANA CON PRECINTO	4,9600	248
49389	RACOR SOLDAR 2P CURVO 2AGCU 1" x 28 JUNTA PLANA CON PRECINTO	5,5400	248
49405	REDUCCION COBRE *FIG.5240*H-H DE 12 x 10	0,9600	249
49406	REDUCCION COBRE *FIG.5240*H-H DE 14 x 12	0,5900	249
49407	REDUCCION COBRE *FIG.5240*H-H DE 15 x 10	1,2300	249
49408	REDUCCION COBRE *FIG.5240*H-H DE 15 x 12	0,8800	249
49409	REDUCCION COBRE *FIG.5240*H-H DE 15 x 14	0,9400	249
49410	REDUCCION COBRE *FIG.5240*H-H DE 16 x 12	0,7200	249
49411	REDUCCION COBRE *FIG.5240*H-H DE 16 x 14	0,7200	249
49412	REDUCCION COBRE *FIG.5240*H-H DE 16 x 15	1,6100	249
49413	REDUCCION COBRE *FIG.5240*H-H DE 18 x 12	1,1900	249
49414	REDUCCION COBRE *FIG.5240*H-H DE 18 x 14	0,8900	249
49415	REDUCCION COBRE *FIG.5240*H-H DE 18 x 15	0,8400	249
49416	REDUCCION COBRE *FIG.5240*H-H DE 18 x 16	0,9900	249
49417	REDUCCION COBRE *FIG.5240*H-H DE 22 x 12	2,8500	249
49418	REDUCCION COBRE *FIG.5240*H-H DE 22 x 14	1,4100	249
49419	REDUCCION COBRE *FIG.5240*H-H DE 22 x 15	1,7100	249
49420	REDUCCION COBRE *FIG.5240*H-H DE 22 x 16	1,2700	249
49421	REDUCCION COBRE *FIG.5240*H-H DE 22 x 18	1,2600	249
49422	REDUCCION COBRE *FIG.5240*H-H DE 28 x 12	4,5600	249
49423	REDUCCION COBRE *FIG.5240*H-H DE 28 x 15	2,9800	249
49424	REDUCCION COBRE *FIG.5240*H-H DE 28 x 18	2,5700	249
49425	REDUCCION COBRE *FIG.5240*H-H DE 28 x 22	1,9800	249
49427	REDUCCION COBRE *FIG.5240*H-H DE 35 x 18	7,6300	249
49428	REDUCCION COBRE *FIG.5240*H-H DE 35 x 22	4,8300	249
49429	REDUCCION COBRE *FIG.5240*H-H DE 35 x 28	5,2500	249
49432	REDUCCION COBRE *FIG.5240*H-H DE 42 x 28	8,7500	249
49433	REDUCCION COBRE *FIG.5240*H-H DE 54 x 42	11,9600	249
49434	REDUCCION COBRE *FIG.5240*H-H DE 64 x 54	27,7900	249
49435	REDUCCION COBRE *FIG.5240*H-H DE 42 x 35	6,5000	249
49436	REDUCCION COBRE *FIG.5240* H-H DE 54 x 35	14,7000	249
49437	REDUCCION COBRE *FIG, 5240*H-H DE 64 x 35	21,7800	249
49440	REDUCCION COBRE *FIG.5240*H-H DE 54 x 28	18,3500	249
49441	REDUCCION COBRE *FIG.5240*H-H DE 67 x 54	24,6900	249
49442	REDUCCION COBRE *FIG.5240*H-H DE 76 x 54	45,4000	249
49443	REDUCCION COBRE *FIG.5240*H-H DE 76 x 64	39,8300	249
49448	REDUCCION COBRE *FIG.5243*M-H DE 12 x 10	1,2200	250
49449	REDUCCION COBRE *FIG.5243*M-H DE 14 x 12	0,4600	250
49450	REDUCCION COBRE *FIG.5243*M-H DE 15 x 10	1,2300	250
49451	REDUCCION COBRE *FIG.5243*M-H DE 15 x12	0,8100	250
49452	REDUCCION COBRE *FIG.5243*M-H DE 15 x14	0,8600	250
49453	REDUCCION COBRE *FIG.5243*M-H DE 16 x12	0,6500	250
49454	REDUCCION COBRE *FIG.5243*M-H DE 16 x14	0,5200	250
49455	REDUCCION COBRE *FIG.5243*M-H DE 18 x 12	0,8900	250
49456	REDUCCION COBRE *FIG.5243*M-H DE 18 x 14	0,7600	250
49457	REDUCCION COBRE *FIG.5243*M-H DE 18 x 15	0,6800	250
49458	REDUCCION COBRE *FIG.5243*M-H DE 18 x 16	0,9500	250
49459	REDUCCION COBRE *FIG.5243*M-H DE 22 x 12	2,2700	250
49460	REDUCCION COBRE *FIG.5243*M-H DE 22 x 14	0,9800	250
49461	REDUCCION COBRE *FIG.5243*M-H DE 22 x 15	0,8300	250
49462	REDUCCION COBRE *FIG.5243*M-H DE 22 x 16	0,8500	250



49463	REDUCCION COBRE *FIG.5243*M-H DE 22 x 18	1,1200	250
49464	REDUCCION COBRE *FIG.5243*M-H DE 28 x 12	3,3800	250
49465	REDUCCION COBRE *FIG.5243*M-H DE 28 x 14	2,8300	250
49466	REDUCCION COBRE *FIG.5243*M-H DE 28 x 15	2,2500	250
49467	REDUCCION COBRE *FIG.5243*M-H DE 28 x 16	2,7100	250
49468	REDUCCION COBRE *FIG.5243*M-H DE 28 x 18	2,2100	250
49469	REDUCCION COBRE *FIG.5243*M-H DE 28 x 22	1,8700	250
49470	REDUCCION COBRE *FIG.5243*M-H DE 35 x 15	8,9400	250
49471	REDUCCION COBRE *FIG.5243*M-H DE 35 x 18	4,9900	250
49472	REDUCCION COBRE *FIG.5243*M-H DE 35 x 22	4,7200	250
49473	REDUCCION COBRE *FIG.5243*M-H DE 35 x 28	3,9000	250
49474	REDUCCION COBRE *FIG.5243*M-H DE 42 x 18	21,4500	250
49475	REDUCCION COBRE *FIG.5243*M-H DE 42 x 22	10,4800	250
49476	REDUCCION COBRE *FIG.5243*M-H DE 42 x 28	6,9300	250
49477	REDUCCION COBRE *FIG.5243*M-H DE 42 x 35	6,2500	250
49478	REDUCCION COBRE *FIG.5243*M-H DE 54 x 28	16,6000	250
49479	REDUCCION COBRE *FIG.5243*M-H DE 54 x 35	13,9900	250
49480	REDUCCION COBRE *FIG.5243*M-H DE 54 x 42	11,4200	250
49481	REDUCCION COBRE *FIG.5243*M-H DE 64 x 54	21,6500	250
49482	REDUCCION COBRE *FIG.5243*M-H DE 67 x 54	25,9300	250
49483	REDUCCION COBRE *FIG.5243*M-H DE 76 x 54	40,6000	250
49484	REDUCCION COBRE *FIG.5243*M-H DE 76 x 64	35,1800	250
49485	REDUCCION COBRE *FIG.5243*M-H DE 80 x 67	35,1800	250
49600	CODO COBRE 90 *FIG.5090*H-H DE 10	0,7400	251
49601	CODO COBRE 90 *FIG.5090*H-H DE 12	1,0500	251
49602	CODO COBRE 90 *FIG.5090*H-H DE 14	0,7600	251
49603	CODO COBRE 90 *FIG.5090*H-H DE 15	0,8600	251
49604	CODO COBRE 90 *FIG.5090*H-H DE 16	0,8300	251
49605	CODO COBRE 90 *FIG.5090*H-H DE 18	1,0600	251
49606	CODO COBRE 90 *FIG.5090*H-H DE 22	1,8700	251
49607	CODO COBRE 90 *FIG.5090*H-H DE 28	3,2700	251
49608	CODO COBRE 90 *FIG.5090*H-H DE 35	7,9500	251
49609	CODO COBRE 90 *FIG.5090*H-H DE 42	12,3500	251
49610	CODO COBRE 90 *FIG.5090*H-H DE 54	19,5300	251
49611	CODO COBRE 90 *FIG.5090*H-H DE 64	48,7500	251
49612	CODO COBRE 90 *FIG.5090*H-H DE 67	71,8000	251
49613	CODO COBRE 90 *FIG.5090*H-H DE 76	94,2300	251
49614	CODO COBRE 90 *FIG.5090*H-H DE 80	104,0500	251
49615	CODO COBRE 90 *FIG.5090*H-H DE 108	221,7900	251
49616	CODO COBRE 90*FIG.5092 *M-H DE 10	1,7900	251
49617	CODO COBRE 90*FIG.5092 *M-H DE 12	0,8400	251
49618	CODO COBRE 90*FIG.5092 *M-H DE 14	0,5700	251
49619	CODO COBRE 90*FIG.5092 *M-H DE 15	0,8400	251
49620	CODO COBRE 90*FIG.5092 *M-H DE 16	0,9500	251
49621	CODO COBRE 90*FIG.5092 *M-H DE 18	1,5500	251
49622	CODO COBRE 90*FIG.5092 *M-H DE 22	2,4900	251
49623	CODO COBRE 90*FIG.5092 *M-H DE 28	3,1200	251
49624	CODO COBRE 90*FIG.5092 *M-H DE 35	9,9500	251
49625	CODO COBRE 90 *FIG.5092*M-H DE 42	14,0900	251
49626	CODO COBRE 90 *FIG.5092*M-H DE 54	26,5700	251
49627	CODO COBRE 90 *FIG.5092*M-H DE 64	69,7400	251
49628	CODO COBRE 90 *FIG.5092*M-H DE 67	89,5700	251
49703	MANGUITO UNION COBRE*FIG.5270 H-H DE 10 x 10	0,4600	251
49704	MANGUITO UNION COBRE*FIG.5270 H-H DE 12 x 12	0,5000	251



49705	MANGUITO UNION COBRE*FIG.5270 H-H DE 14 x 14	0,4300	251
49706	MANGUITO UNION COBRE*FIG.5270 H-H DE 15 x 15	0,3600	251
49707	MANGUITO UNION COBRE*FIG.5270 H-H DE 18 x 18	0,6700	251
49708	MANGUITO UNION COBRE*FIG.5270 H-H DE 22 x 22	1,1800	251
49709	MANGUITO UNION COBRE*FIG.5270 H-H DE 28 x 28	1,3400	251
49710	MANGUITO UNION COBRE*FIG.5270 H-H DE 35 x 35	2,6900	251
49711	MANGUITO UNION COBRE*FIG.5270 H-H DE 42 x 42	4,3000	251
49712	MANGUITO UNION COBRE*FIG.5270 H-H DE 54 x 54	9,6700	251
49713	MANGUITO UNION COBRE*FIG.5270 H-H DE 64 x 64	22,3300	251
49714	MANGUITO UNION COBRE*FIG.5270 H-H DE 67 x 67	33,0300	251
49715	MANGUITO UNION COBRE*FIG.5270 H-H DE 76 x 76	29,0500	251
49716	MANGUITO UNION COBRE*FIG.5270 H-H DE 80 x 80	33,6200	251
49718	MANGUITO UNION COBRE*FIG.5270 H-H DE 108 x 108	92,6100	251
49516	TAPON COBRE *FIG.5301*H- DE 10	1,7600	252
49517	TAPON COBRE *FIG.5301*H- DE 12	0,8500	252
49518	TAPON COBRE *FIG.5301*H- DE 14	0,9600	252
49519	TAPON COBRE *FIG.5301*H- DE 15	0,7000	252
49520	TAPON COBRE *FIG.5301*H- DE 16	1,2700	252
49521	TAPON COBRE *FIG.5301*H- DE 18	1,0600	252
49522	TAPON COBRE *FIG.5301*H- DE 22	1,4200	252
49523	TAPON COBRE *FIG.5301*H-DE 28	2,2800	252
49524	TAPON COBRE *FIG.5301*H-DE 35	7,4400	252
49525	TAPON COBRE *FIG.5301*H-DE 42	8,2500	252
49526	TAPON COBRE *FIG.5301*H-DE 54	16,5700	252
49643	CURVA COBRE 90*FIG.5001-A * M-H 10	1,9800	252
49644	CURVA COBRE 90*FIG.5001-A * M-H 12	0,9900	252
49645	CURVA COBRE 90*FIG.5001-A * M-H 14	0,6500	252
49646	CURVA COBRE 90*FIG.5001-A * M-H 15	1,1300	252
49647	CURVA COBRE 90*FIG.5001-A * M-H 16	0,7400	252
49648	CURVA COBRE 90*FIG.5001-A * M-H 18	1,8000	252
49649	CURVA COBRE 90*FIG.5001-A * M-H 22	2,6300	252
49650	CURVA COBRE 90*FIG.5001-A * M-H 28	3,1600	252
49651	CURVA COBRE 90*FIG.5001-A * M-H 35	8,9900	252
49652	CURVA COBRE 90*FIG.5001-A * M-H 42	13,8500	252
49653	CURVA COBRE 90*FIG.5001-A * M-H 54	25,7400	252
49660	CURVA COBRE 90*FIG.5002-A * H-H DE 10	0,9300	252
49661	CURVA COBRE 90*FIG.5002-A * H-H DE 12	0,7200	252
49662	CURVA COBRE 90*FIG.5002-A * H-H DE 14	0,5700	252
49663	CURVA COBRE 90*FIG.5002-A * H-H DE 15	0,9800	252
49664	CURVA COBRE 90*FIG.5002-A * H-H DE 16	1,0700	252
49665	CURVA COBRE 90*FIG.5002-A * H-H DE 18	1,6000	252
49666	CURVA COBRE 90*FIG.5002-A * H-H DE 22	3,5000	252
49667	CURVA COBRE 90*FIG.5002-A * H-H DE 28	3,5600	252
49668	CURVA COBRE 90*FIG.5002-A * H-H DE 35	5,7900	252
49669	CURVA COBRE 90*FIG.5002-A * H-H DE 42	13,3800	252
49670	CURVA COBRE 90*FIG.5002-A * H-H DE 54	19,9900	252
49671	CURVA COBRE 90*FIG.5002-A * H-H DE 64	65,5200	252
49672	CURVA COBRE 90*FIG.5002-A * H-H DE 67	81,4900	252
49673	CURVA COBRE 90*FIG.5002-A * H-H DE 76	113,1200	252
49674	CURVA COBRE 90*FIG.5002-A * H-H DE 80	145,1500	252
49501	CURVA COBRE-45 *FIG.5041*H-H DE 10	2,8000	253
49502	CURVA COBRE-45 *FIG.5041*H-H DE 12	0,9200	253
49503	CURVA COBRE-45 *FIG.5041*H-H DE 14	0,6700	253
49504	CURVA COBRE-45 *FIG.5041*H-H DE 15	0,8300	253



49505	CURVA COBRE-45 *FIG.5041*H-H DE 16	0,9100	253
49506	CURVA COBRE-45 *FIG.5041*H-H DE 18	1,3300	253
49507	CURVA COBRE-45 *FIG.5041*H-H DE 22	2,2800	253
49508	CURVA COBRE-45 *FIG.5041*H-H DE 28	2,6400	253
49509	CURVA COBRE-45 *FIG.5041*H-H DE 35	7,3900	253
49510	CURVA COBRE-45 *FIG.5041*H-H DE 42	9,9700	253
49511	CURVA COBRE-45 *FIG.5041*H-H DE 54	23,4500	253
49512	CURVA COBRE-45 *FIG.5041*H-H DE 64	80,1700	253
49513	CURVA COBRE-45 *FIG.5041*H-H DE 67	81,8500	253
49514	CURVA COBRE-45 *FIG.5041*H-H DE 76	97,4700	253
49515	CURVA COBRE-45 *FIG.5041*H-H DE 80	107,8800	253
49631	CURVA COBRE 45 *FIG.5040* M-H DE 10	2,4900	253
49632	CURVA COBRE 45 *FIG.5040* M-H DE 12	0,7700	253
49633	CURVA COBRE 45 *FIG.5040* M-H DE 14	0,8200	253
49634	CURVA COBRE 45 *FIG.5040* M-H DE 15	0,6100	253
49635	CURVA COBRE 45 *FIG.5040* M-H DE 18	1,3500	253
49636	CURVA COBRE 45 *FIG.5040* M-H DE 22	2,2600	253
49637	CURVA COBRE 45 *FIG.5040* M-H DE 28	2,2400	253
49638	CURVA COBRE 45 *FIG.5040* M-H DE 35	8,0300	253
49639	CURVA COBRE 45 *FIG.5040* M-H DE 42	13,7600	253
49640	CURVA COBRE 45 *FIG.5040* M-H DE 54	23,0400	253
49641	CURVA COBRE 45 *FIG.5040* M-H DE 64	77,7900	253
49642	CURVA COBRE 45 *FIG.5040* M-H DE 67	88,9400	253
49680	CURVA DESVIACION *FIG.5086* M-H DE 12	4,3200	253
49681	CURVA DESVIACION *FIG.5086* M-H DE 14	4,6800	253
49682	CURVA DESVIACION *FIG.5086* M-H DE 15	2,1800	253
49683	CURVA DESVIACION *FIG.5086* M-H DE 16	5,1100	253
49684	CURVA DESVIACION *FIG.5086* M-H DE 18	5,2800	253
49685	CURVA DESVIACION *FIG.5086* M-H DE 22	7,4700	253
49688	CURVA DESVIACION *FIG.5085* H-H DE 12	4,9400	253
49689	CURVA DESVIACION *FIG.5085* H-H DE 14	5,0300	253
49690	CURVA DESVIACION *FIG.5085* H-H DE 15	2,9800	253
49691	CURVA DESVIACION *FIG.5085* H-H DE 18	7,4300	253
49692	CURVA DESVIACION *FIG.5085* H-H DE 22	8,5600	253
49531	TE IGUAL COBRE *FIG.5130*DE 10	1,5800	254
49532	TE IGUAL COBRE *FIG.5130*DE 12	1,3200	254
49533	TE IGUAL COBRE *FIG.5130*DE 14	0,6700	254
49534	TE IGUAL COBRE *FIG.5130*DE 15	1,1200	254
49535	TE IGUAL COBRE *FIG.5130*DE 16	0,8100	254
49536	TE IGUAL COBRE *FIG.5130*DE 18	1,8500	254
49537	TE IGUAL COBRE *FIG.5130*DE 22	3,6400	254
49538	TE IGUAL COBRE *FIG.5130*DE 28	6,5500	254
49539	TE IGUAL COBRE *FIG.5130*DE 35	16,1500	254
49540	TE IGUAL COBRE *FIG.5130*DE 42	20,8700	254
49541	TE IGUAL COBRE *FIG.5130*DE 54	40,0500	254
49542	TE IGUAL COBRE *FIG.5130*DE 64	86,3200	254
49543	TE IGUAL COBRE *FIG.5130*DE 67	94,3400	254
49544	TE IGUAL COBRE *FIG.5130*DE 76	110,2200	254
49545	TE IGUAL COBRE *FIG.5130*DE 80	148,1900	254
49546	TE IGUAL COBRE *FIG.5130*DE 108	252,5600	254
49549	TE REDUCIDA COBRE *FIG.5130 R*DE 12 x 10 x 10	2,7000	254
49550	TE REDUCIDA COBRE *FIG.5130 R*DE 12 x 14 x 12	1,7900	254
49551	TE REDUCIDA COBRE *FIG.5130 R*DE 12 x 15 x 12	3,4600	254
49552	TE REDUCIDA COBRE *FIG.5130 R*DE 14 x 12 x 12	1,2800	254



49553	TE REDUCIDA COBRE *FIG.5130 R*DE 14 x 12 x 14	1,0200	254
49554	TE REDUCIDA COBRE *FIG.5130 R*DE 14 x 14 x 12	1,2000	254
49555	TE REDUCIDA COBRE *FIG.5130 R*DE 14 x 18 x 14	5,3800	254
49557	TE REDUCIDA COBRE FIG. 5130 R *DE 15 x 12 x 12	6,5400	254
49558	TE REDUCIDA COBRE FIG. 5130 R *DE 15 x 12 x 15	1,5000	254
49559	TE REDUCIDA COBRE FIG. 5130 R *DE 15 x 15 x 12	3,3300	254
49560	TE REDUCIDA COBRE FIG. 5130 R *DE 15 x 18 x 15	4,1400	254
49561	TE REDUCIDA COBRE FIG. 5130 R *DE 15 x 22 x 15	6,8200	254
49562	TE REDUCIDA COBRE FIG.5130 R *DE 16 x 12 x 12	2,0700	254
49563	TE REDUCIDA COBRE FIG.5130 R *DE 16 x 12 x 14	1,5900	254
49564	TE REDUCIDA COBRE FIG.5130 R *DE 16 x 12 x 16	1,5000	254
49565	TE REDUCIDA COBRE FIG.5130 R *DE 16 x 14 x 12	2,2400	254
49566	TE REDUCIDA COBRE FIG.5130 R *DE 16 x 14 x 14	1,5100	254
49567	TE REDUCIDA COBRE FIG.5130 R *DE 16 x 14 x 16	1,2900	254
49568	TE REDUCIDA COBRE FIG.5130 R *DE 16 x 22 x 16	4,8900	254
49569	TE REDUCIDA COBRE FIG.5130 R *DE 18 x 12 x 12	5,9900	254
49570	TE REDUCIDA COBRE FIG.5130 R *DE 18 x 12 x 15	10,6900	254
49571	TE REDUCIDA COBRE FIG.5130 R *DE 18 x 12 x 16	3,3900	254
49572	TE REDUCIDA COBRE FIG.5130 R *DE 18 x 12 x 18	2,2400	254
49573	TE REDUCIDA COBRE FIG.5130 R *DE 18 x 14 x 14	2,7200	254
49574	TE REDUCIDA COBRE FIG.5130 R *DE 18 x 14 x 18	1,5100	254
49575	TE REDUCIDA COBRE FIG.5130 R *DE 18 x 15 x 12	6,6600	254
49576	TE REDUCIDA COBRE FIG.5130 R *DE 18 x 15 x 15	1,8500	254
49577	TE REDUCIDA COBRE FIG.5130 R *DE 18 x 15 x 18	1,6600	254
49578	TE REDUCIDA COBRE FIG.5130 R *DE 18 x 16 x 16	2,8600	254
49579	TE REDUCIDA COBRE FIG.5130 R *DE 18 x 16 x 18	2,6400	254
49580	TE REDUCIDA COBRE FIG.5130 R *DE 18 x 18 x 12	7,2300	254
49581	TE REDUCIDA COBRE *FIG.5130 R*DE 18 x 18 x 14	2,8000	254
49582	TE REDUCIDA COBRE *FIG.5130 R*DE 18 x 18 x 15	2,0200	254
49583	TE REDUCIDA COBRE *FIG.5130 R*DE 18 x 22 x 18	4,4300	255
49584	TE REDUCIDA COBRE *FIG.5130 R*DE 18 x 28 x 18	2,7800	255
49585	TE REDUCIDA COBRE *FIG.5130 R*DE 22 x 12 x 12	7,1100	255
49586	TE REDUCIDA COBRE *FIG.5130 R*DE 22 x 12 x 22	5,6000	255
49587	TE REDUCIDA COBRE *FIG.5130 R*DE 22 x 14 x 14	5,5000	255
49588	TE REDUCIDA COBRE *FIG.5130 R*DE 22 x 14 x 22	2,5500	255
49589	TE REDUCIDA COBRE *FIG.5130 R*DE 35-22-35	10,0500	255
49590	TE REDUCIDA COBRE *FIG.5130 R*DE 22 x 15 x15	2,9800	255
49591	TE REDUCIDA COBRE *FIG.5130 R*DE 22 x 15 x 18	3,3000	255
49592	TE REDUCIDA COBRE *FIG.5130 R*DE 42 x 22 x 42	21,7700	255
49593	TE REDUCIDA COBRE *FIG.5130 R*DE 22 x 15 x 22	1,4600	255
49594	TE REDUCIDA COBRE *FIG.5130 R*DE 22 x 16 x 16	4,3800	255
49595	TE REDUCIDA COBRE *FIG.5130 R*DE 54 x 22 x 54	30,6000	255
49596	TE REDUCIDA COBRE *FIG.5130 R*DE 22 x 16 x 22	2,6600	255
49597	TE REDUCIDA COBRE *FIG.5130 R*DE 22 x 18 x 15	6,1900	255
49598	TE REDUCIDA COBRE *FIG.5130 R*DE 22 x 18 x 18	3,4500	255
49599	TE REDUCIDA COBRE *FIG.5130 R*DE 22 x 18 x 22	3,5300	255
49806	TE REDUCIDA COBRE *FIG.5130 R*DE 22 x 22 x 12	8,2000	255
49807	TE REDUCIDA COBRE *FIG.5130 R*DE 22 x 22 x 15	4,3600	255
49808	TE REDUCIDA COBRE *FIG.5130 R*DE 22 x 22 x 18	5,0900	255
49809	TE REDUCIDA COBRE *FIG.5130 R*DE 22 x 28 x 22	8,6100	255
49810	TE REDUCIDA COBRE *FIG.5130 R*DE 28 x 12 x 28	10,7300	255
49811	TE REDUCIDA COBRE *FIG.5130 R*DE 28 x 15 x 15	11,0400	255
49812	TE REDUCIDA COBRE *FIG.5130 R*DE 28 x 15 x 22	8,0700	255
49813	TE REDUCIDA COBRE *FIG.5130 R*DE 28 x 15 x 28	6,0900	255



49814	TE REDUCIDA COBRE *FIG.5130 R*DE 28 x 16 x 28	6,9800	255
49815	TE REDUCIDA COBRE *FIG.5130 R*DE 28 x 18 x 15	11,8700	255
49816	TE REDUCIDA COBRE *FIG.5130 R*DE 28 x 18 x 18	12,0300	255
49817	TE REDUCIDA COBRE *FIG.5130 R*DE 28 x 18 x 22	8,0400	255
49818	TE REDUCIDA COBRE *FIG.5130 R*DE 28 x 18 x 28	5,5100	255
49819	TE REDUCIDA COBRE *FIG.5130 R*DE 28 x 22 x 15	12,6100	255
49820	TE REDUCIDA COBRE *FIG.5130 R*DE 28 x 22 x 18	11,3900	255
49821	TE REDUCIDA COBRE *FIG.5130 R*DE 28 x 22 x 22	6,5700	255
49822	TE REDUCIDA COBRE *FIG.5130 R*DE 28 x 22 x 28	3,7000	255
49823	TE REDUCIDA COBRE *FIG.5130 R*DE 28 x 28 x 15	12,5500	255
49824	TE REDUCIDA COBRE *FIG.5130 R*DE 28 x 28 x 18	10,8500	255
49825	TE REDUCIDA COBRE *FIG.5130 R*DE 28 x 28 x 22	8,8800	255
49826	TE REDUCIDA COBRE *FIG.5130 R*DE 28 x 35 x 28	16,4800	255
49831	TE REDUCIDA COBRE *FIG.5130 R*DE 35 x 15 x 35	31,0300	255
49832	TE REDUCIDA COBRE *FIG.5130 R*DE 35 x 18 x 35	19,2200	255
49834	TE REDUCIDA COBRE *FIG.5130 R*DE 35 x 22 x 28	13,9200	255
49835	TE REDUCIDA COBRE *FIG.5130 R*DE 35 x 28 x 22	20,8900	255
49836	TE REDUCIDA COBRE *FIG.5130 R*DE 35 x 28 x 28	14,2700	255
49837	TE REDUCIDA COBRE *FIG.5130 R*DE 35 x 28 x 35	14,3100	255
49838	TE REDUCIDA COBRE *FIG.5130 R*DE 35 x 35 x 22	25,5000	255
49839	TE REDUCIDA COBRE *FIG.5130 R*DE 35 x 35 x 28	24,0900	255
49840	TE REDUCIDA COBRE *FIG.5130 R*DE 42 x 28 x 42	24,4200	255
49841	TE REDUCIDA COBRE *FIG.5130 R*DE 42 x 35 x 35	39,1500	255
49842	TE REDUCIDA COBRE *FIG.5130 R*DE 42 x 35 x 42	30,2100	255
49843	TE REDUCIDA COBRE *FIG.5130 R*DE 42 x 42 x 28	41,6000	255
49851	TE REDUCIDA COBRE *FIG.5130 R*DE 64 x 42 x 64	83,3600	255
49852	TE REDUCIDA COBRE *FIG.5130 R*DE 54 x 28 x 54	58,4800	255
49853	TE REDUCIDA COBRE *FIG.5130 R*DE 54 x 35 x 54	52,6100	255
49854	TE REDUCIDA COBRE *FIG.5130 R*DE 54 x 42 x 54	53,0500	255





MEDITERRÁNEA DE VÁLVULAS, S.L.

Pol. Ind. Torrubero - Av. Constitución. 5 - 46136 MUSEROS (Valencia) España

Tel. 96 185 82 03 - Fax 96 185 83 90

info@meval.es - www.meval.es